

Nashville

DOWNTOWN CODE

Chapter 17.37 of the Metropolitan Nashville and Davidson County Zoning Code

Attachment to Ordinance No. BL2009-586
as adopted on February 02, 2010

Amended by Ordinance No. BL2020-334
as adopted on August 21, 2020

Amended by Ordinance No. BL2017-827
as adopted on August 15, 2017

Amended by Ordinance No. BL2016-133
as adopted on September 06, 2016

Amended by Ordinance No. BL2015-1253
as adopted on August 18, 2015

Amended by Ordinance No. BL2015-1053
as adopted on August 04, 2015

Amended by Ordinance No. BL2015-1048
as adopted on April 21, 2015

Amended by Ordinance No. BL2013-376
as adopted on March 19, 2013

Amended by Ordinance No. BL2012-142
as adopted on May 15, 2012

Amended by Ordinance No. BL2011-896
as adopted on May 17, 2011

Document Contact Information

Planning Department staff provides consultations for developing within the Downtown Code. Call (615) 862-7190 or email planningstaff@nashville.gov to schedule a meeting.

DRAFT

 The Planning Department does not discriminate on the basis of age, race, sex, color, national origin, religion or disability in access to, or operation of, its programs, services, and activities, or in its hiring or employment practices. For ADA inquiries, contact Josie Bass, ADA Compliance Coordinator, at 615-862-7150 or e-mail her at josie.bass@nashville.gov. For Title VI inquiries contact Shirley Sims-Saldana or Denise Hopgood of Human Relations at 615-880-3370. For all employment-related inquiries call 615-862-6640.

Section I: Introduction

Table of Contents

Section I: Introduction	5	Parking and Access	80
The Downtown Code and the Downtown Plan	6	Specific to Structured Parking	81
DTC Regulating Plan	11	Specific to Surface Parking	82
Application of the DTC	12	Mechanical, Service and Loading	83
General Provisions	12	Fences and Walls	84
Applicable Chapters and Sections of the Zoning Code	12	Open Space	85
How to Use this Document	13	Plan	86
Modifications	14	General Standards	87
Design Review Committee	14	Specific to Greens	88
Compliance	15	Specific to Squares	89
		Specific to Plazas	90
		Specific to Courts	91
		Specific to Pocket Parks and Playgrounds	92
Section II: Subdistrict Standards	17	Bonus Height Program	93
James Robertson Subdistrict	18	BHP Chart	99
Core Subdistrict	20		
Core Historic Subdistrict	22	Section V: Sign Standards.	101
Upper Broadway Subdistrict	26	Introductory Provisions.	103
2nd and Broadway Subdistrict	28	Intent	
River Subdistrict.	32	Applicability	
SoBro Subdistrict	34	Sign Permit Applications	
Lafayette Subdistrict.	38	Common Sign Plan	
Rutledge Hill Subdistrict	40	Modifications	104
Rolling Mill Hill Subdistrict.	42	Right-of-way Encroachments.	104
Rutledge River Subdistrict	44	Nonconforming Signs	104
Gulch North Subdistrict	46	Repair and Maintenance	104
Gulch South Subdistrict.	48	General Standards.	105
Hope Gardens Subdistrict	50	Other Sign Types	105
Sulphur Dell Subdistrict.	52	Street Types	106
		Street Types Map	107
Section III: Uses	55	Determining Sign Entitlements.	108
Use Areas	56	Allocation of Sign Area by Street Types	109-110
Use Tables.	57	Building Signs	
		Wall Sign	111
Section IV: General Standards	59	Awning Sign	112
Calculations	61	Canopy Sign	113
Street Character	62	Projecting Sign	114
Future Streets Plan	66	Shingle Sign	115
Lots and Frontages	67	Ground Signs	
Specific to Storefront Frontage.	70	Monument Sign.	116
Specific to Stoop Frontage	72	Skyline Signs	117
Specific to Porch Frontage	74	Illumination	118
Specific to Industrial Frontage	76	Changeable Copy	119
Specific to Civic Frontage	78		
Canopies and Awnings	79		

This page left intentionally blank

DRAFT

DRAFT

Section I: Introduction

The Downtown Code and the Downtown Plan

The Downtown Code (DTC) implements the community vision set forth in the Downtown Community Plan: 2007 Update. Through the community planning process, stakeholders reached a common vision for the future of Downtown. The Plan envisions multiple distinct neighborhoods within Downtown, each with its own character and scale, which contribute to the vitality of Downtown as the center of the city and the region.

The DTC regulates the physical form of buildings to ensure each makes a positive contribution to a complete urban environment. By ensuring a specific and predictable urban form, the DTC ensures that all new construction makes a positive contribution to the public realm – streets and open space – and that all investments are held to the same standard.

While the DTC is a regulating document, the Downtown Plan contains placemaking tools and guidelines and should be used as a companion document to the DTC.

The Guiding Principles of the Downtown Plan have directed the standards in the DTC and are as follows:

Ensure that Downtown remains the civic, commercial and entertainment center for Nashville, Middle Tennessee and the Southeast.

- The regulations of the DTC clarify the vision for each neighborhood in Downtown. Under the DTC, certain areas are allowed to have high-rise towers, while others are zoned for neighborhood-scale development, while still others are allowed to be more transitional with support uses necessary to sustain urban business.
- In recent years, nearly all projects in Downtown have sought rezoning or variances to existing zoning. The DTC alleviates this need by allowing significantly greater development rights, in forms based on construction norms and urban design objectives, than existing zoning. The DTC also allows the modification of standards for site-specific issues.

Provide opportunities for continued growth while preserving and enhancing the character that inspires residents and businesses to move Downtown.

- The Downtown Plan called for areas of increased height and density within Downtown. The Plan extended the boundaries of the Core – the tallest and most intense neighborhood – and provided guidance regarding additional height in other neighborhoods. The DTC codifies these opportunities in the subdistrict standards for these neighborhoods.
- Similarly, the Downtown Plan acknowledged the difficulty of developing within the sky exposure plane in some neighborhoods. The DTC modified the allowable form of build-

ings by allowing additional height at the street in exchange for an overall height-cap. The result is that properties, and thus neighborhoods, will have the same intensity as in CF zoning but in a form that is aligned with typical construction methods and creates a more predictable urban environment.

- The form and shape of development under CC and CF zoning is unpredictable. The DTC provides clear direction on minimum development and maximum development. For instance, the Gulch is zoned for a specific character, while Sulphur Dell is zoned for something different. This ensures certainty about the character and scale of development in each neighborhood.
- In an urban environment, the street level design and function of a building is of the utmost importance. The interaction of the building with the street should enliven the street, making it comfortable, safe and interesting for pedestrians. The DTC is based on frontage design – storefront, stoop, porch, industrial, and civic – and includes standards on glazing, vehicular access, landscaping, and active uses on the ground level. Correctly designed, these attributes will contribute to safe and interesting streets to result in vibrant neighborhoods and a healthy Downtown.
- A safe and interesting urban environment attracts people. People who feel comfortable in Downtown – enjoying available activities, prospering from the businesses and services, and lingering in the spaces and places – want to be Downtown. The DTC fosters this desirable urban environment through the attention to pedestrian-oriented design, appropriate scale and massing, and neighborhood creation.

Section I: Introduction

The Downtown Code and the Downtown Plan

Create strategic mixed use to facilitate Downtown's transformation into a 24/7 community.

- The Plan calls for a “thoughtful mixture of uses including residential, retail and office, to ensure that Downtown doesn’t close at 5 p.m. or even after the concert ends or the restaurants close, but is instead a welcoming home for a diverse residential population.” Multiple stories encourage multiple uses within each building, increasing the likelihood that one of the uses will be active at any given hour. Compare this to one story buildings which lack activity during the off-hours of the single use.
- To be viable, Downtown must accommodate numerous services and functions. By promoting form over use, the DTC allows for a mixture of uses. Because various functions occur at different times of the day – working, shopping and recreating during the day, entertainment and home-life at night – mixed-use, 24/7 neighborhoods use existing infrastructure more efficiently and function in a more sustainable way.

Create and nurture urban neighborhoods.

- As stated in the Plan, “While residential *development* has flourished in recent years, the creation and enhancement of urban *neighborhoods* is still a goal. Residential living will thrive in Downtown when residents feel that they are part of a neighborhood, supported by shared public spaces and the services and amenities needed for daily life.” The DTC directly addresses the development characteristics of neighborhood design: building mass and scale, frontage design, and open space design.
- To create these distinctive urban neighborhoods, the DTC aligns the regulations of each subdistrict with the intended character of the neighborhood. For instance, the South Gulch is envisioned to continue as a high-rise and mid-rise, mixed-use neighborhood. The DTC codifies mid-rise height in the general subdistrict and allows high-rise buildings on key intersections and along important streets. In contrast, the North Gulch is envisioned to be a low-rise neighborhood – to preserve Capitol views and transition into the Hope Gardens and John Henry Hale neighborhoods. The DTC codifies this vision by capping the overall

height, allowing for less intense development such as two story houses and townhouses, and encouraging porch and stoop frontages. These are two examples of how the DTC aligns the zoning of neighborhoods with the vision cast during the community planning process.

- “Since 2000, Downtown has experienced an unprecedented residential boom. In 2000, there were approximately 1500 dwelling units in Downtown. As of 2006, over 2600 new residential units were under construction, planned or proposed... Since 2000 there has been over \$500 million in capital investments in residential construction, with another \$400 million planned or proposed.” In addition, “since 2000, Downtown office building development has grown modestly with \$140 million of development completely or under construction.” These strong numbers increase the viability of Downtown. To continue this good momentum, the emphasis must be on place-making as well as development. The DTC encourages the creation of mixed-use, sustainable neighborhoods that have flexibility to address the needs of citizens over time.

Create active, attractive streets and streetscapes.

- “...the Downtown Plan encourages walking as a primary mode of transportation in Downtown. Walking is encouraged in the Downtown Plan by making the walk safe, interesting, and comfortable...” Streets are the most plentiful open space in Downtown and should prioritize the pedestrian experience while appropriately accommodating vehicular traffic. The DTC emphasizes frontage design, requires active ground level uses, and sets standards for vehicular activity.
- The DTC prioritizes the location of vehicular access points per street type – Primary, Secondary, Tertiary, Other, and Alley. By prioritizing, instead of regulating, the DTC allows flexibility for site-specific solutions to be reached in collaboration between the developer and Metro departments.
- While the DTC sets standards on the development of private property, active and attractive streets must be created by a collaborative process with all Metro Departments. As development proposals are offered, Metro will retain a commitment to creating a strong pedestrian-oriented urban

Section I: Introduction

The Downtown Code and the Downtown Plan

environment. “As Downtown becomes home to many of its workers, and mass transit options into Downtown improve, providing welcoming routes for pedestrians will provide benefits in terms of improved mobility and reduced traffic congestion.”

- The DTC references the *Downtown Streetscape Design Guidelines*, and the *Major and Collector Street Plan* created by Metro Public Works and Metro Planning, and requires their use.

Protect and reuse historic structures and districts.

- The DTC has a subdistrict for 2nd Avenue and Lower Broadway that reinforces the historic zoning overlay for these streets. To encourage the adaptive reuse of the historic structures, this subdistrict is eligible for transfer of development rights through the Bonus Height Program.
- The creation of the Core Historic subdistrict encourages the preservation of the existing historic buildings between 3rd and 5th Avenues North, while allowing for appropriately scaled and appropriately detailed infill.
- The creation of the Rutledge Hill subdistrict encourages the preservation of the existing historic buildings in this historic residential area, while allowing for appropriately scaled and appropriately detailed infill.
- During the community planning process, the preservation of views to the Capitol building was identified as important to the development of neighborhoods north of Capitol Hill. The maximum building heights in subdistricts north of Capitol Hill are limited to the elevation of the base of the Capitol building to ensure this that this important civic view is preserved.

Create environmentally sustainable and energy efficient development.

- In order to meet the sustainability goals of the Downtown Plan and to achieve Metro Government’s vision of Nashville as the greenest city in the US, the DTC encourages urban infill and energy efficient development.
- By location alone, urban infill is more energy efficient than green-field development because it utilizes existing streets and infrastructure. By emphasizing mixed-use, walkable neighborhoods within Downtown, the DTC reinforces Metro Government’s commitment to sustainability and responsible use of resources. Part of being sustainable is

using existing under-utilized infrastructure – water lines, sewer lines, electricity, and streets – in lieu of creating new infrastructure and continuing green-field consumption.

- Location, however, does not ensure sustainability. The creation of the DTC emphasizes the need for a denser Downtown to provide citizens with all daily needs within walking distance, the need for buildings that can be adapted for new uses over time, the preservation and adaptive reuse of existing buildings, and the addition of street trees and open spaces.
- In addition to encouraging sustainable urbanity, the DTC encourages the measurement of energy efficient development through the US Green Building Council’s LEED program. (LEED may be substituted for a different nationally-recognized, third-party system of overseeing green building and/or sustainable development practices.)
- The Bonus Height Program of the DTC provides height bonuses for new construction that meets the standards of LEED silver, gold or platinum. LEED takes credits a project for its urban environment, but also for the sustainability of the building itself. The public benefit associated with LEED certification is significant. The lighter the building treads on the infrastructure of the city, the lighter the burden on the city to maintain the infrastructure. This helps the city function better as a whole. The bonuses are appropriately scaled for each subdistrict and are offered in exchange for the level of contribution of this important public benefit.

Create “great spaces” throughout Downtown for the enjoyment of citizens and visitors.

- In some areas of Downtown, open space is appropriately scaled and designed for the envisioned intensity of the neighborhood. In most areas, however, open space is dramatically lacking. The DTC identifies ¼ mile radius neighborhoods (about a five minute walk from edge to center) within Downtown to show the open space deficiencies. For every quarter mile neighborhood, there should be at least a quarter acre of well-designed public open space. This open space may be provided by public or private initiatives.
- The Downtown Plan recommended that Downtown have unique types of open space available to meet the needs of citizens. The DTC provides standards for the creation

Section I: Introduction

The Downtown Code and the Downtown Plan

of these open spaces: greens, squares, plazas, courts and pocket parks/playgrounds. The open spaces will serve as important “great spaces” to help create the vital and functioning neighborhoods envisioned by the Downtown Plan.

- The Bonus Height Program of the DTC provides height bonuses for the development of public open spaces. To be eligible for the height bonus, the development must follow the standards for open space design. The bonuses are appropriately scaled for each subdistrict and are offered in exchange for this important public amenity.

Provide for improved mobility in and through Downtown to support other principles for healthy growth in Downtown.

- “The Downtown Plan encourages walking as a primary mode of transportation in Downtown.” The DTC standards focus on the interaction between the building and street – the frontage of the building – to make the pedestrian realm safe, comfortable and interesting. This goal will be reached when public and private entities remain committed to creating a pedestrian-oriented Downtown.
- The Downtown Plan notes that “as Downtown becomes home to many of its workers, and mass transit options into Downtown improve, providing welcoming routes for pedestrians will provide benefits in terms of improved

mobility and reduced traffic congestion.” While the DTC sets standards on the development of private property, improved transportation options must be created by a collaborative process between the public and private sectors.

The Downtown Plan sets forth the common vision for the future of Downtown, and acknowledges that “the creation of the Downtown envisioned by the community can only be achieved through cooperative efforts of the public and private sectors and through the informed involvement of residents, businesses and investors in Downtown. Adherence to these guiding principles in the development actions of both the public and private sector will create the Downtown Nashville that the community has envisioned – an expanding, vibrant Downtown with opportunities for growth and development that embody the urban experience of a great city.” The DTC is one of several tools to strengthen Downtown through public and private investments.

By focusing on the creation of distinctive neighborhoods, pedestrian-oriented development, the DTC reaches toward the goal of an economically healthy, socially vibrant, and sustainable Downtown.

This page left intentionally blank







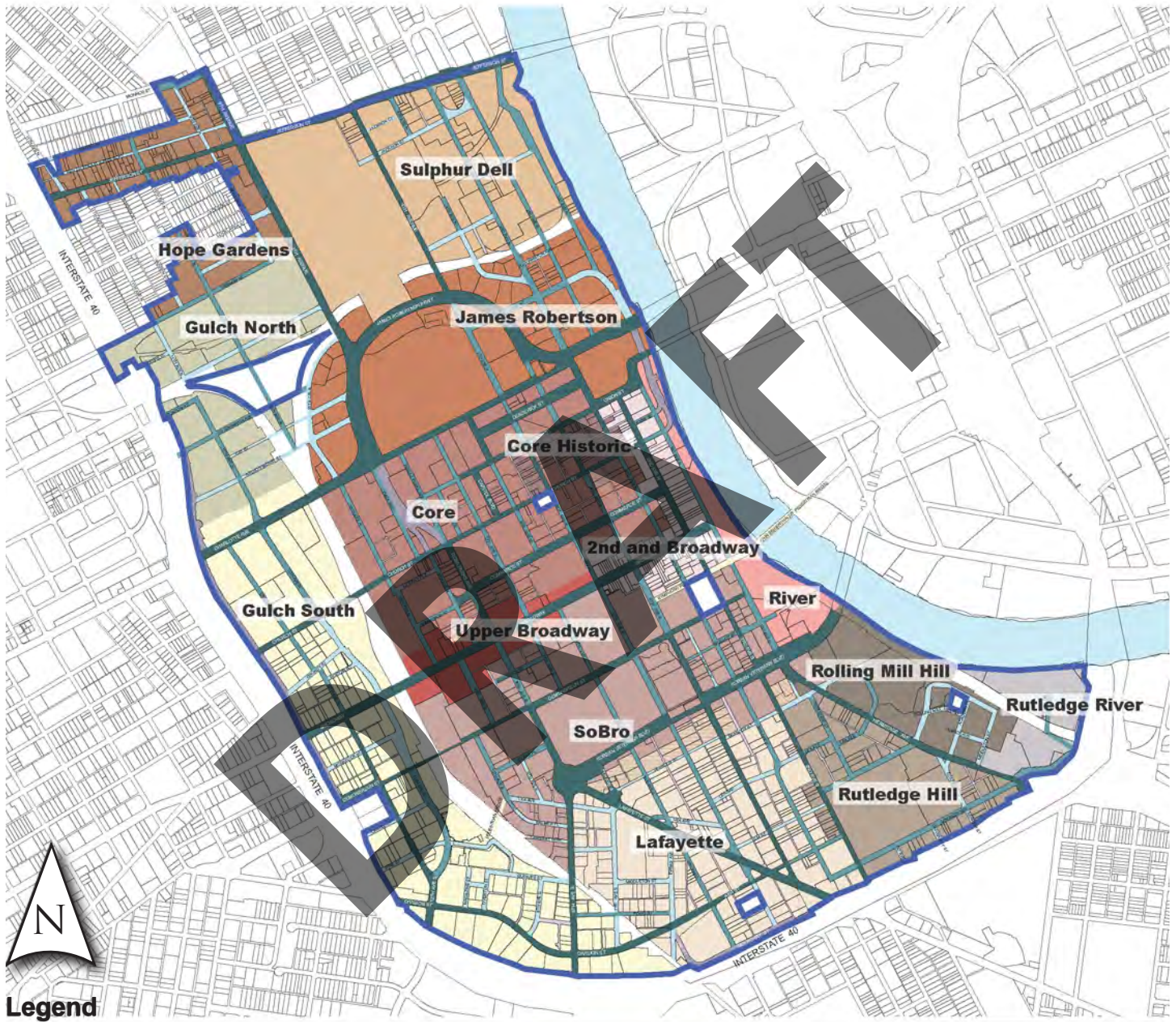









DRAFT

Section I: Introduction

DTC Regulating Plan: Subdistrict Boundaries



Legend

 James Robertson Subdistrict - page 18	 Upper Broadway Subdistrict - page 26	 Lafayette Subdistrict - page 38	 Gulch North Subdistrict - page 46
 Core Subdistrict - page 20	 SoBro Subdistrict - page 34	 Rutledge Hill Subdistrict - page 40	 Hope Gardens Subdistrict - page 50
 Core Historic Subdistrict - page 22	 River Subdistrict - page 32	 Rutledge River Subdistrict - page 44	 Sulphur Dell Subdistrict - page 52
 2nd and Broadway Subdistrict - page 28	 Rolling Mill Hill Subdistrict - page 42	 Gulch South Subdistrict - page 48	 DTC Boundary

Section I: Introduction

Application of the DTC

General Provisions

If necessary, to adhere to the laws and regulations of Federal, State, or local departments or agencies, the regulations in this chapter may be modified. Such modifications may be approved by the Planning Commission, the DTC Design Review Committee or Planning Staff, in accordance with the Modifications section of this Chapter.

To the extent that the provisions of the Downtown Code is inconsistent or in conflict with the provisions of the Gateway Urban Design Overlay District that is also zoned DTC, the provisions of the DTC zoning shall be controlling; however, any provisions of the Gateway UDO may be used provided that the standards of the DTC zoning are met.

Applicable Chapters and Sections of the Zoning Code

In addition to the standards set forth within this document, the following Chapters and Sections of the Metro Zoning Code shall apply to properties with DTC zoning.

- All of Chapter 17.04 GENERAL PROVISIONS AND DEFINITIONS
- Within Chapter 17.08 ZONING DISTRICTS AND LAND USE TABLES
 - Section - 17.08.010 Zoning districts established.
 - Section - 17.08.020 Zoning districts described.
- All of Chapter 17.16 LAND USE DEVELOPMENT STANDARDS
- Within Chapter 17.20 PARKING, LOADING AND ACCESS
 - Section - 17.20.050 Handicapped parking.
 - Section - 17.20.060 Parking area design standards.
 - Section - 17.20.070 Queuing requirements for drive-through facilities.
 - Section - 17.20.130 Loading space requirements.
- Within Chapter 17.24 LANDSCAPING, BUFFERING AND TREE REPLACEMENT
 - Section - 17.24.010 Purpose and intent.
 - Section - 17.24.020 Landscape plan required.
 - Section - 17.24.030 Standards for form and quality of plants.
 - Section - 17.24.040 Spacing standards.
- Article II. Tree Protection and Replacement
 - Section - 17.24.090 Removal of protected trees.
 - Section - 17.24.100 Replacement of trees.
 - Section - 17.24.110 Protection of trees during development activities.
 - Section - 17.24.120 Less desirable trees.
 - Section - 17.24.160 Interior planting requirements.
 - Section - 17.24.170 Nonconforming parking areas.
- All of Chapter 17.28 ENVIRONMENTAL AND OPERATIONAL PERFORMANCE STANDARDS
- All of Chapter 17.32 SIGN REGULATIONS
- All of Chapter 17.36 OVERLAY DISTRICTS, except Article XII, Urban Zoning Overlay (UZO) District.
- All of Chapter 17.40 ADMINISTRATION AND PROCEDURES, except as otherwise provided for within this document.

Section I: Introduction

Application of the DTC: How to Use this Document

How to Use this Document

The Downtown Code is organized by Subdistricts and Street Types, as identified on the Regulating Plan.

To determine the standards which apply to a particular property:

- On the Regulating Plan, identify the Subdistrict in which the property is located and on what type of street(s) it fronts.
- Consult the Building Regulations for development standards relevant to the Subdistrict.
- Consult the Use Table for uses allowed in each Area.
- Consult the General Standards section for guidance on development standards for all Subdistricts.

Subdistricts and Areas

- Downtown Nashville consists of numerous neighborhoods with unique character. The development standards for the DTC are organized by Subdistricts, which establish the zoning of each neighborhood to create or maintain the envisioned character.
- The DTC is divided into 4 Areas (North, South, West and Central), which establish the allowed uses.
- The DTC includes General Standards that apply to all Subdistricts.

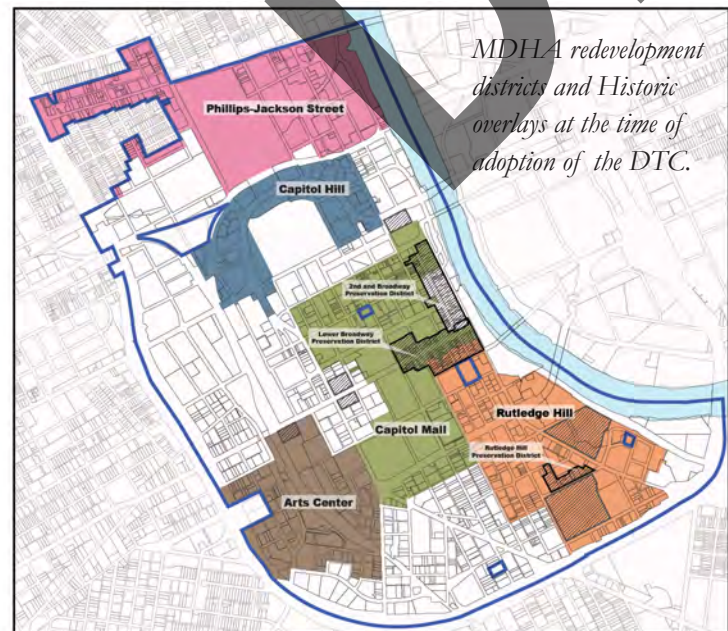

Regulating Plan

- The Regulating Plan is the official zoning map of the DTC. The Subdistrict boundaries are shown on the series of maps which comprise the Regulating Plan.
- Subdistrict boundaries extend to the centerline of all abutting public street right-of-ways. Any properties not within the subdistrict boundaries of the regulating plan including, but not limited to, rail and river corridors shall be considered an open space subdistrict.
- Unless otherwise regulated by the DTC subdistrict standards, property that is within more than one subdistrict may apply for a minor modification to use the standards of either subdistrict. If the Executive Director of the Planning Department finds that additional consideration is warranted, then the modification request may be submitted to the Downtown Code/MDHA Design Review Committee as a major modification.

Overlapping Plans

Within the area governed by the DTC, there exist other regulations and design guidelines intended to work in conjunction with the DTC. The DTC does not exempt development from complying with the regulations of other Federal, State, and Local departments and agencies. These departments and agencies should be contacted during the development process to address their rules, regulations and policies.

Section I: Introduction

Application of the DTC: Modifications

Modifications to the Standards

Based on site-specific issues, an applicant may seek modifications to the standards of this document.

Any standard within the DTC may be modified, insofar as the intent of the standard is being met, the modification results in better urban design for the neighborhood as a whole, and the modification does not impede or burden existing or future development of adjacent properties.

The DTC, the Downtown Plan and any other policies and regulations from governing agencies shall be consulted when considering modifications. Any standards that shall not be modified are explicitly noted in this document.

Modifications may be approved by Planning staff, the Downtown Code Design Review Committee (DTC DRC) or the Planning Commission.

- Minor modifications – deviations of 20 percent or less – or modifications explicitly noted herein as minor may be approved by Planning Staff.
- Any determination made by the Planning Staff may be appealed to the DTC DRC.
- Major modifications – deviations of more than 20 percent – and modifications of standards without numbers may be approved by the DTC DRC. Within MDHA redevelopment districts, the MDHA DRC shall act as the DTC DRC.
- Any determination made by the DTC DRC or the MDHA DRC regarding standards of the DTC may be appealed to the Planning Commission by the applicant or the Planning Department.

Variations and special exceptions

Variations and special exceptions that are not specifically for standards of the DTC zoning district shall follow the procedures of Chapter 17.40, Articles VII and VIII of the zoning code. Standards specific to the DTC zoning district may be modified based on the modifications section of this document.

Overall Height Modifications

- For modifications to overall height, the Executive Director of the Planning Department shall determine whether the development has made reasonable efforts to use all appropriate bonuses available in the Bonus Height Program. The Executive Director's decision may be appealed to the DTC DRC/MDHA DRC. If it has been determined that all reasonable efforts have been made to use the Bonus Height Program, the applicant shall hold a community meeting providing notices to property owners within 300 feet, and the Planning Commission shall review the modification request and may grant additional height for exceptional design, including but not limited to unique architecture, exceptionally strong streetscape, contribution to the skyline, improvement of the project's relationship to surrounding properties, improvement to the character of the neighborhood. In some instances, where the project results in implementation of significant community improvements (such as quality open space, upgrading public infrastructure, or others determined by the policies of Metro departments), and/or contribution to the implementation of community improvements determined by the policies of Metro departments.”

Application Process

The DTC DRC shall review and approve a DTC Concept Plan for a site prior to approval of a DTC Final Site Plan.

- The DTC, the Downtown Plan, other policies and regulations from governing agencies, and other best practices shall be consulted when considering a DTC Concept Plan.
- Modifications shall be requested concurrently with the DTC Concept Plan.
- Within MDHA redevelopment districts, the MDHA DRC shall act as the DTC DRC.
- Any determination made by the Planning Staff may be appealed to the DTC DRC. Any determination made by the DTC DRC or the MDHA DRC regarding standards of the DTC may be appealed to the Planning Commission by the applicant or the Planning Department.

Section I: Introduction

Application of the DTC: Design Review and Compliance

Design Review Committee

The DTC DRC is subject to the rules and procedures adopted by the Planning Commission. The DTC DRC will consist of eight (8) voting members.

One member shall be nominated by each of the following with confirmation by the Planning Commission:

- Chamber of Commerce
- Civic Design Center
- Downtown Partnership
- Urban Residents Association

One member shall be appointed by the following:

- Mayor
- Vice-Mayor, on behalf of the Metro Council
- Historic Commission
- Planning Commission

Each member shall be a design professional, with a degree or several years of experience in architecture, landscape architecture, planning or urban design. The members nominated by the Nashville Area Chamber of Commerce and the Nashville Downtown Partnership shall be exempt from this requirement.

Each term shall be four years, with the appointees of the Mayor, Vice-Mayor and Planning Commission serving an initial two-year term upon adoption of the DTC. Any vacancy occurring during the unexpired term of any members shall be filled in the manner prescribed herein for the original selection of the members of the DTC DRC. A new mayor and/or new vice mayor may appoint a new representative after the term of the existing representative has expired.

Compliance with the DTC shall be required according to the following:

- Level 1: An addition of twenty-five percent or less of the square footage of the existing building
 - Shall not increase the degree of nonconformity.
- Level 2: An addition of more than twenty-five percent of the square footage of the existing building or 1000 square feet, whichever is greater
 - Improvements to the sidewalk corridor according to the *Major and Collector Street Plan*.
 - Where possible, the addition of street trees
 - Parking lot landscaping standards
 - Shall not increase the degree of nonconformity.
- Level 3: Redevelopment after the demolition or destruction of more than five percent and less than fifty percent of the existing building
 - Improvements to the sidewalk corridor according to the *Major and Collector Street Plan*.
 - Where possible, the addition of street trees
 - Parking lot landscaping standards
 - To the extent practicable, new construction shall be in compliance with applicable standards of the DTC.
- Level 4: Redevelopment after the demolition or destruction of more than fifty percent of the existing building
 - All standards of the DTC
 - Improvements to the sidewalk corridor according to the *Major and Collector Street Plan*.
- Level 5: New construction of buildings, parking, open space, etc
 - All standards of the DTC
 - Improvements to the sidewalk corridor according to the *Major and Collector Street Plan*.

Signage Compliance

- For those properties within Historic Zoning Overlays, the sign standards of the CF zoning district shall apply, along with historic zoning district design guidelines.
- For those properties not within Historic Zoning Overlays, the sign standards of the DTC zoning district shall apply.
- No new billboards are allowed within the DTC boundaries.

This page left intentionally blank

DRAFT

Section II: Subdistrict Standards

DRAFT



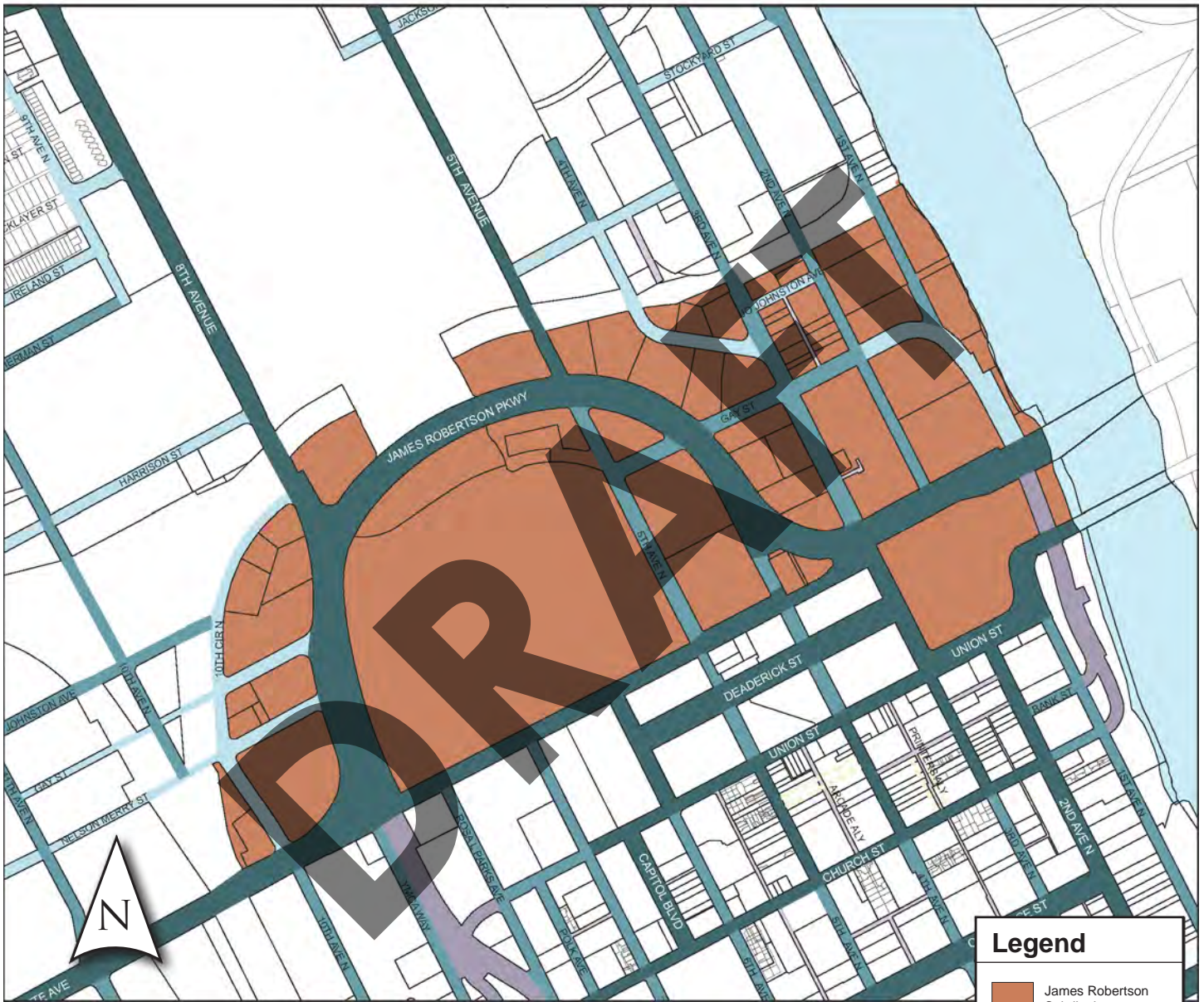

Section II: Subdistrict Standards

James Robertson Subdistrict: Regulating Plan

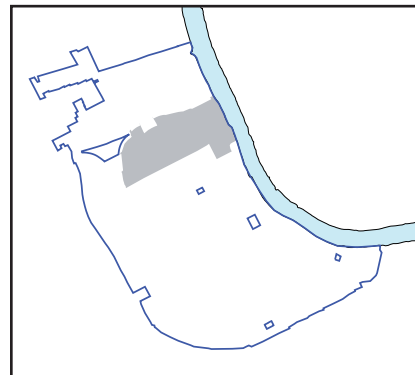

The James Robertson Subdistrict is the primarily civic area surrounding Capitol Hill. The Downtown Plan emphasizes “preserving the James Robertson neighborhood’s treasured civic and open space resources, while encouraging redevelopment to offer a mixture of uses...while recognizing that the area’s uses will continue to be dominated by government activities.” The importance of the State Capitol as a Nashville and Tennessee landmark also warrants maintaining views of the Capitol from all vantage points to the west, north and east. The DTC allows a maximum height of 560’ above sea level (the elevation of the base of the capitol building) to preserve these views.



Legend	
	James Robertson Subdistrict
	Primary Street
	Secondary Street
	Tertiary Street
	Other Street
	Alley

Section II: Subdistrict Standards

James Robertson Subdistrict: Building Regulations

Frontage

A Allowed Frontage Types with Required Build-to Zone

Primary Street

- Storefront Frontage
 - James Robertson Boulevard
 - West of 3rd Ave 20'-30'
 - East of 3rd Ave 0'-10'
 - Charlotte Avenue 0'-10'
- Stoop Frontage
 - James Robertson Boulevard
 - West of 3rd Ave 20'-30'
 - East of 3rd Ave 5'-10'
 - Charlotte Avenue 5'-10'

Secondary Street

- Storefront Frontage 0'-10'
- Stoop Frontage 5'-10'

Tertiary Street

- Storefront Frontage 0'-10'
- Stoop Frontage 5'-10'

B Facade width

- Primary Street 80% of lot frontage min.
 - Secondary Street 80% of lot frontage min.
 - Tertiary Street 60% of lot frontage min.
- Remaining lot frontage may be used for pedestrian amenities and shall not be used for parking.

C Min. building depth 15' from building facade

A building liner is required surrounding parking structures on the all floors facing James Robertson Blvd.

Height

D Max. elevation of 560'

Step-back *

Step-back required for all buildings 8 stories or greater on all public streets and Open Space

E Step-back between 4th and 8th stories

F Min. step-back depth 15'

* see page 61 for full description

Sidewalk & Planting

Improvements to the sidewalk corridor according to the General Standards and the Major and Collector Street Plan.

Notes

Uses: page 55; General Standards: page 59

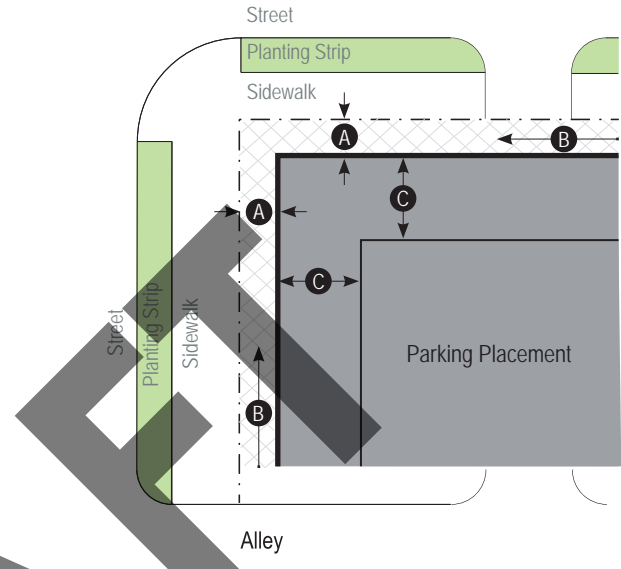

Building Plan

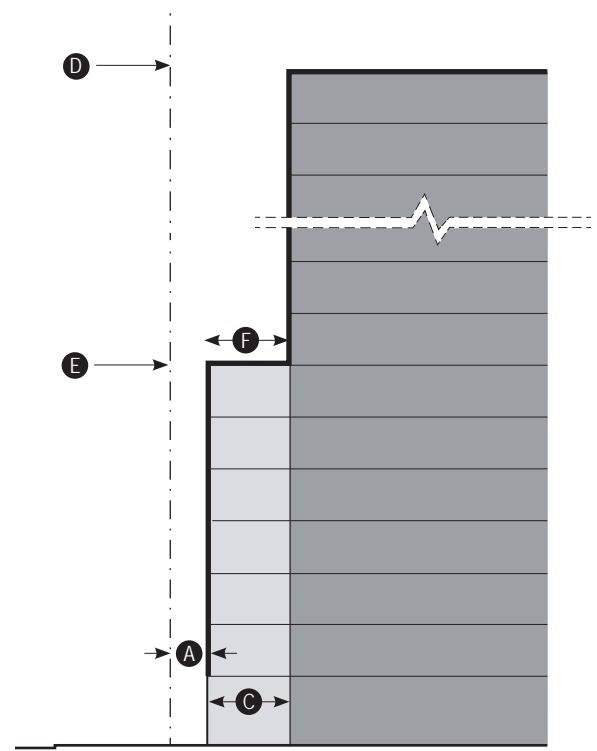

Building Section





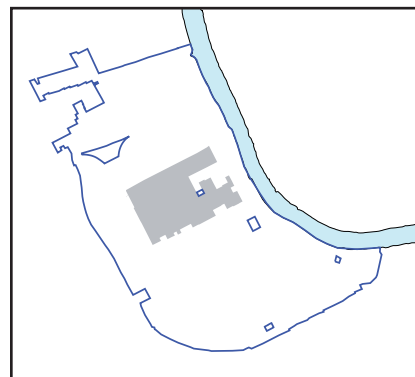

Section II: Subdistrict Standards

Core Subdistrict: Regulating Plan



The Core is the heart of the Downtown business district, the economic engine of the Middle Tennessee region, and a significant economic force in the Southeast. It is the densest neighborhood in Downtown and has the greatest height allowances. Pedestrian comfort and safety should be prioritized with an interesting sidewalk realm, activity on the ground level of buildings, and controlled vehicular access.



Legend	
	Core Subdistrict
	Primary Street
	Secondary Street
	Tertiary Street
	Other Street
	Alley

Section II: Subdistrict Standards

Core Subdistrict: Building Regulations

Frontage

A Allowed Frontage Types with Required Build-to Zone

Primary Street	
• Storefront Frontage	0'-10'
• Stoop Frontage	5'-10'
Secondary Street	
• Storefront Frontage	0'-10'
• Stoop Frontage	5'-10'
Tertiary Street	
• Storefront Frontage	0'-10'
• Stoop Frontage	5'-10'

B Facade width

Primary Street	80% of lot frontage min.
Secondary Street	80% of lot frontage min.
Tertiary Street	60% of lot frontage min.
Remaining lot frontage may be used for pedestrian amenities and shall not be used for parking.	

C Min. building depth

15' from building facade

Height

D Max. 30 stories Additional height available through the Bonus Height Program

Sidewalk & Planting

Improvements to the sidewalk corridor according to the General Standards and the Major and Collector Street Plan.

Notes

Uses: page 55; General Standards: page 59

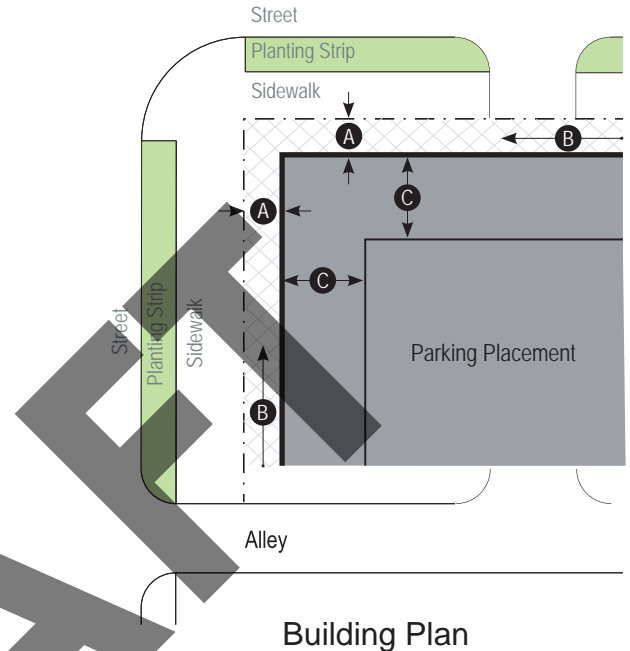

Building Plan

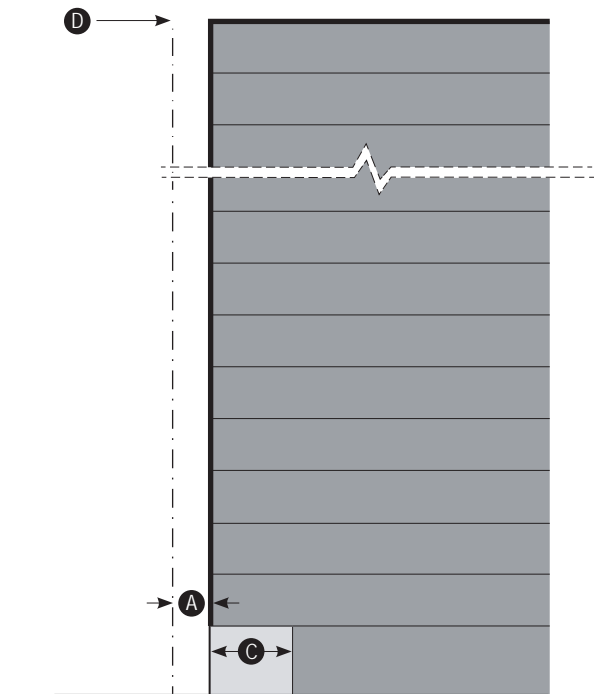

Building Section





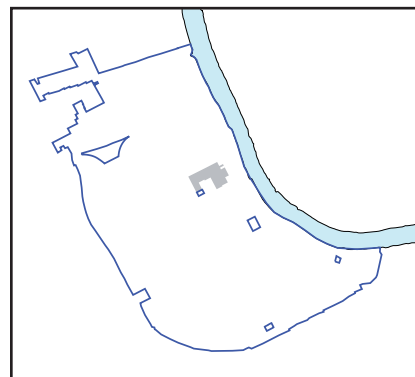

Section II: Subdistrict Standards

Core Historic Subdistrict: Regulating Plan



The Core Historic neighborhood has two historic urban spaces – the Arcade and Printers’ Alley. This neighborhood is comprised several historic buildings, many of which have been recently renovated. The height maximums for this subdistrict reflect historic urban design features – lower buildings mid-block and taller buildings to “book-end” the blocks at the corners. The adaptive reuse of historic buildings is encouraged and new construction should be of appropriate scale and detailing, maintaining the existing storefront rhythm. Pedestrian comfort and safety should be prioritized with an interesting sidewalk realm, activity on the ground level of buildings, and controlled vehicular access.



Legend	
	Core Historic Subdistrict
	Primary Street
	Secondary Street
	Tertiary Street
	Other Street
	Alley
	Pedestrian Frontage

Section II: Subdistrict Standards

Core Historic Subdistrict: Building Regulations

Frontage

A Allowed Frontage Types with Required Build-to Zone

Primary Street	
• Storefront Frontage	0'
• Stoop Frontage	5'-10'
Secondary Street	
• Storefront Frontage	0'
• Stoop Frontage	5'-10'

B Facade width

Primary Street	95% of lot frontage min.
Secondary Street	95% of lot frontage min.

C Min. building depth 15' from building facade

A building liner is required surrounding parking structures on all floors facing public streets and Open Space.

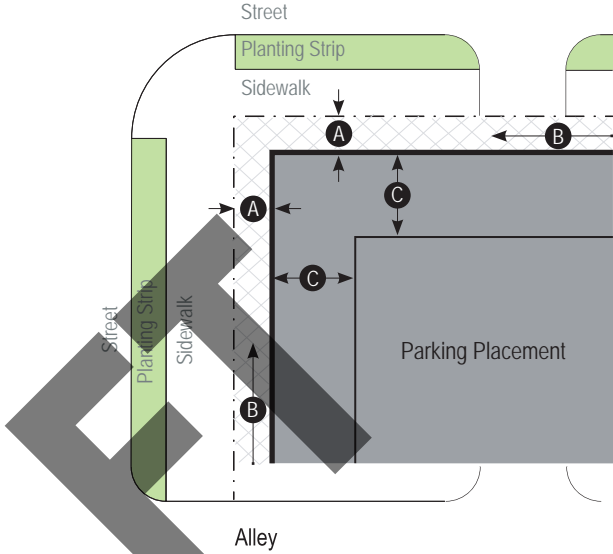

Building Plan

Sidewalk & Planting

Improvements to the sidewalk corridor according to the General Standards and the Major and Collector Street Plan.

Notes

Uses: page 55; General Standards: page 59

DRAFT

Section II: Subdistrict Standards

Core Historic Subdistrict: Building Regulations

Height

D Max.	
On Corners	10 stories
Mid-Block	6 stories

Step-back

Step-back after

E • On Printer's Alley	4 stories
F • All Others	6 stories

Depth

G • On Printer's Alley	10' min.
H • All Others	10' min. and max.

Step-back not required for buildings fronting Church Street.

Buildings 6 stories or less shall not step-back and all stories shall occupy the Build-to Zone.

I Max. tower dimensions	90' x 90'
--------------------------------	-----------

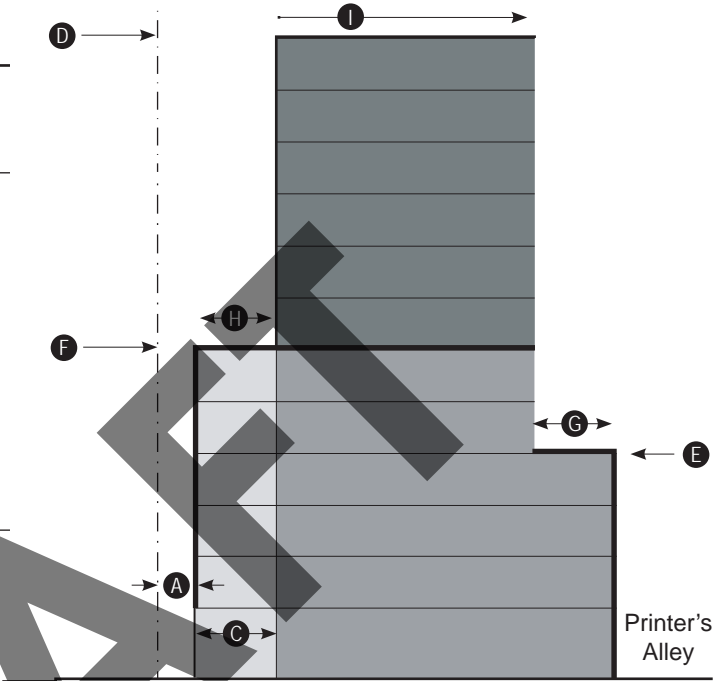

Block Corner Section

DRAFT

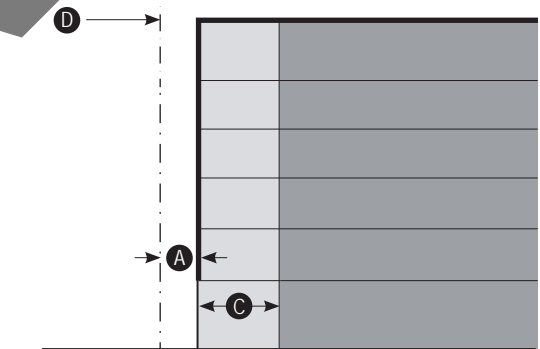

Mid-Block Section

Section II: Subdistrict Standards

Core Historic Subdistrict: Building design and Facade articulation

Building design and Facade articulation

- | | |
|---------------------------------------|--|
| L Primary building divisions | 20'-50' wide |
| M Secondary building divisions | 5'-25' wide
Secondary building divisions are defined by solid vertical elements that consist of changes in materials or planes within the facade. |
| N First Floor height | 16' min. |
- Windows**
- O** Ground floor - 60% glazing required from 2 feet above grade to the finished floor of the 2nd story
 - P** Window sill height 18"-24"
- Q** Upper Floors - Windows shall be vertically oriented at a ratio of 2:1 or greater.

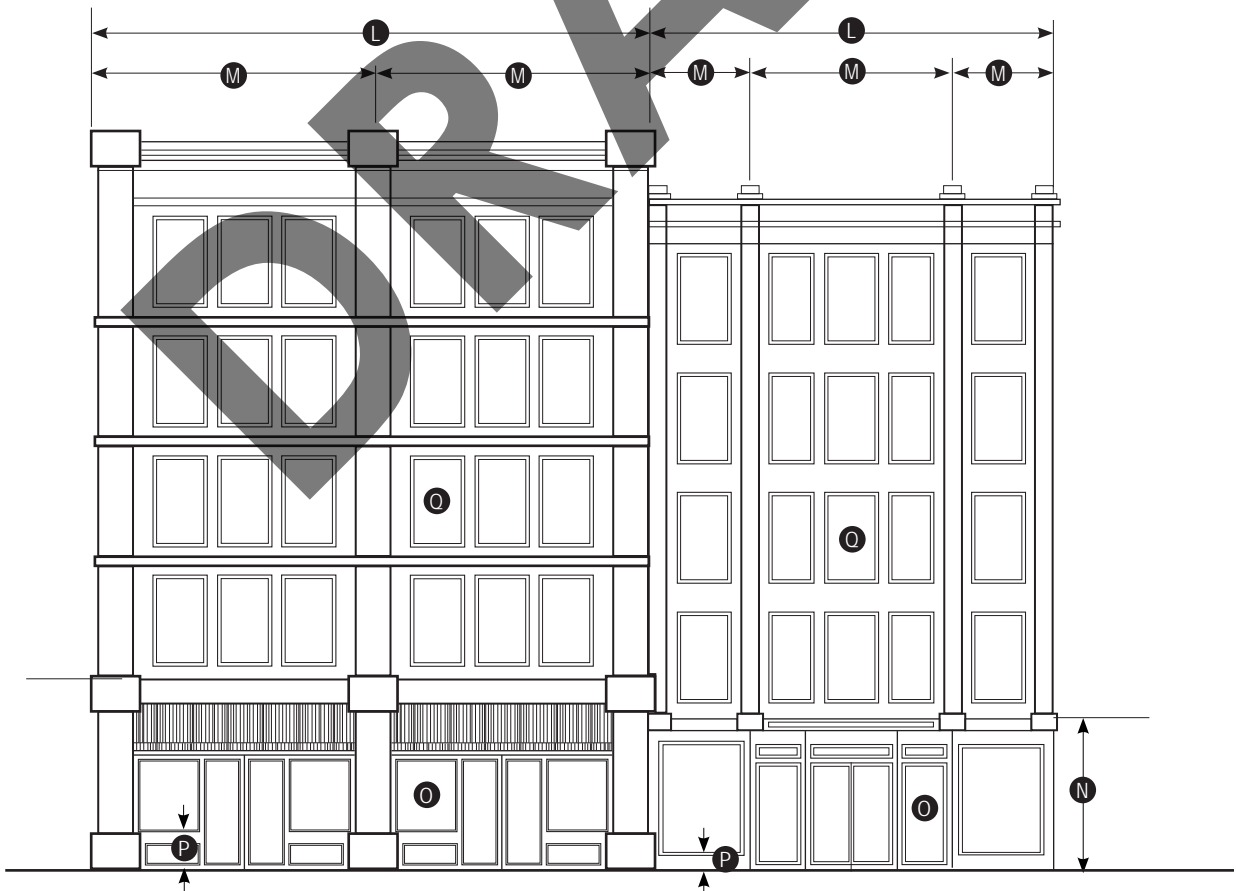

Section II: Subdistrict Standards

Upper Broadway Subdistrict: Regulating Plan



The Upper Broadway area is one of the most important gateways into Downtown. Several civic and cultural buildings front this urban corridor. Maintenance and adaptive reuse of historic buildings is encouraged, and the height and scale of new buildings should be in-keeping with the existing urban pattern. When properties front more than one street, Broadway should be the Principal frontage.

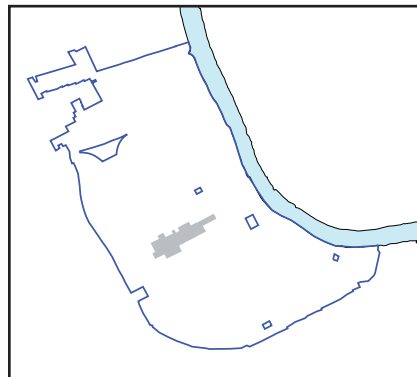

Legend	
	Upper Broadway Subdistrict
	Primary Street
	Secondary Street
	Other Street
	Alley

Section II: Subdistrict Standards

Upper Broadway Subdistrict: Building Regulations

Frontage

A Allowed Frontage Types with Required Build-to Zone

- Primary Street
 - Storefront Frontage 0-5'
 - Secondary Street
 - Storefront Frontage 0'-5'
- ** Civic Frontages are encouraged in this subdistrict.

B Facade width

- Primary Street 80% of lot frontage min.
 - Secondary Street 80% of lot frontage min.
- Remaining lot frontage may be used for pedestrian amenities and shall not be used for parking.

C Min. building depth 15' from building facade

A building liner is required surrounding parking structures on all floors facing Broadway and Open Space.

Height

- D Max.** 100'

Sidewalk & Planting

Improvements to the sidewalk corridor according to the General Standards and the Major and Collector Street Plan.

Notes

Uses: page 55; General Standards: page 59

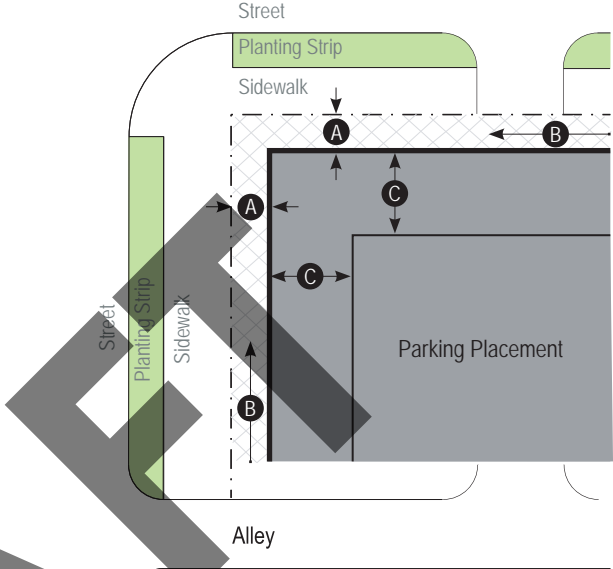

Building Plan

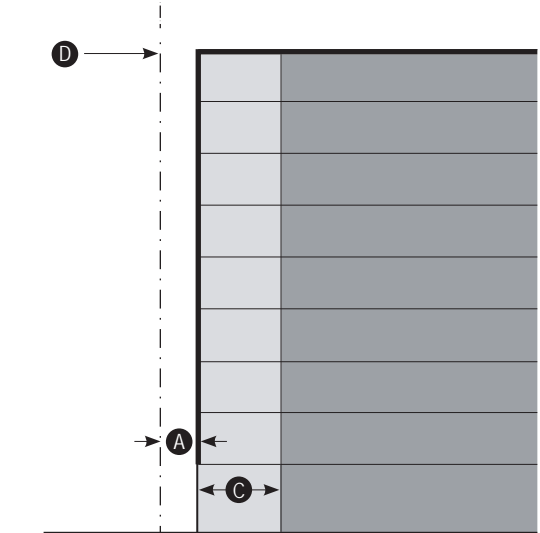

Building Section

Section II: Subdistrict Standards

2nd and Broadway Subdistrict: Regulating Plan

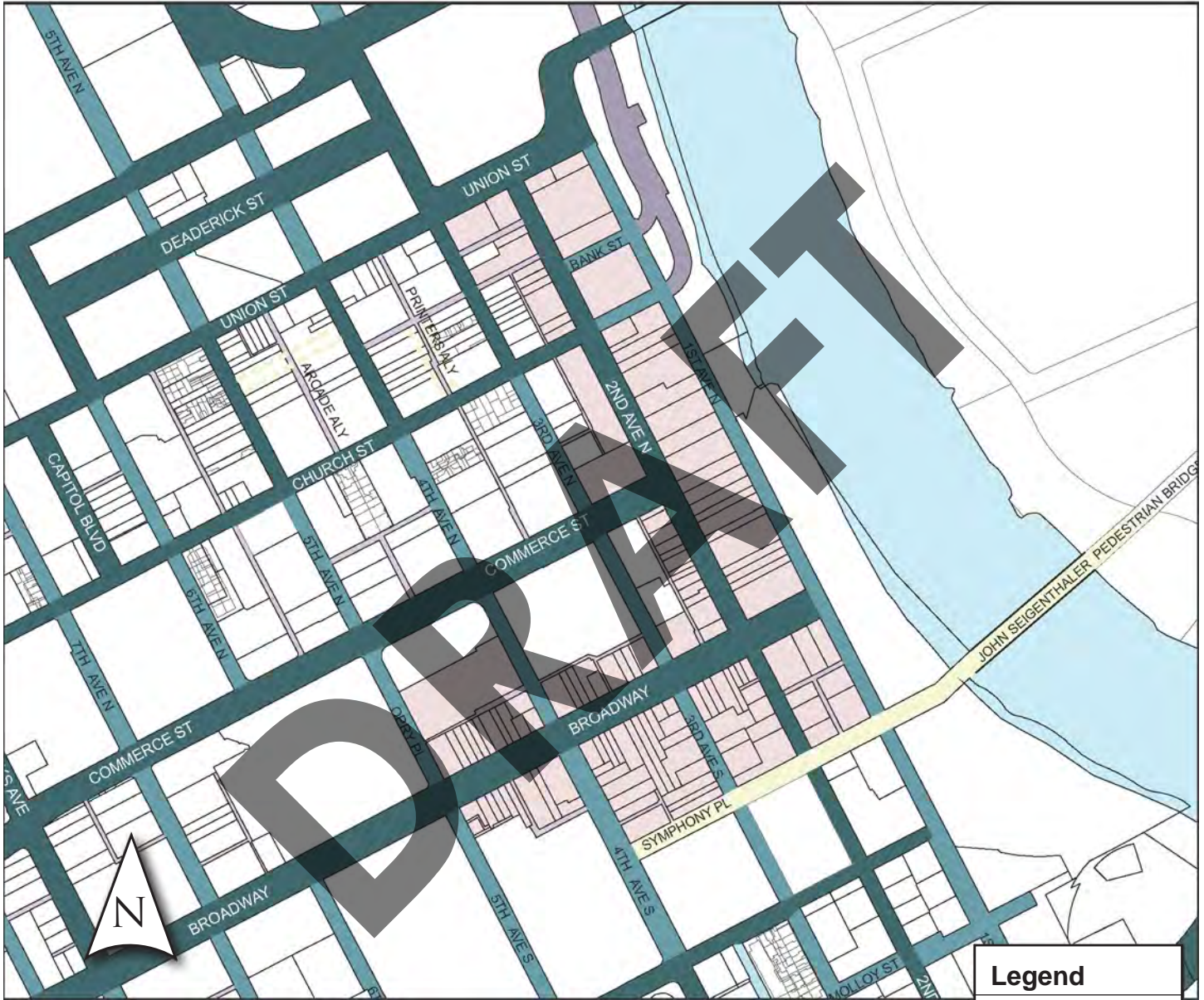

Second and Broadway is the heart of Downtown; where the main street of the city meets the Cumberland River. The Downtown Plan encourages maintaining “the low-scale, pedestrian-friendly historic character” and adaptively reusing existing historic structures “in order to respect, maintain, and enhance not only individual structures, but the existing character of the Second and Broadway neighborhood as a whole.” With the exception of the Stahlman building on the northeast corner of 3rd and Union, this neighborhood is overseen by two historic zoning overlays: *The Second Avenue Historic Zoning Overlay* and *The Broadway Historic Zoning Overlay*. Property owners must contact the Metro Historic Commission for additional details.

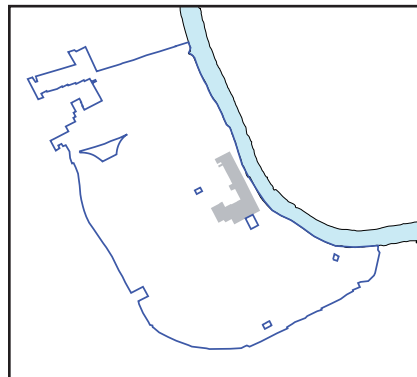

Legend

- 2nd and Broadway Subdistrict
- Primary Street
- Secondary Street
- Other Street
- Alley
- Pedestrian Frontage

Section II: Subdistrict Standards

2nd and Broadway Subdistrict: Building Regulations

Frontage

A Allowed Frontage Types with Required Build-to Zone

Primary Street	
• Storefront Frontage	0'
Secondary Street	
• Storefront Frontage	0'

B Facade width

Primary Street	100% of lot frontage min.
Secondary Street	100% of lot frontage min.

C Min. building depth

15' from building facade

Height

D Min.

40'

E Max. at the street

• On Broadway	5 stories to a max. height of 65'
• On 2nd Ave	8 stories to a max. height of 105'
• On Union St	12 stories to a max. height of 180'
• All other streets	8 Stories to a max. height of 105'

F Min. step-back depth

• On Broadway	30'
• On all other streets	20'

G Max. height

- 1 additional story
- Within 150' of the right-of-way of Broadway, height shall not exceed 6 stories or 80'
- Between 150' and 200' of the right-of-way of Broadway, height shall not exceed 7 stories or 90'.

Sidewalk & Planting

Improvements to the sidewalk corridor according to the General Standards and the Major and Collector Street Plan.

Notes

Uses: page 55; General Standards: page 59

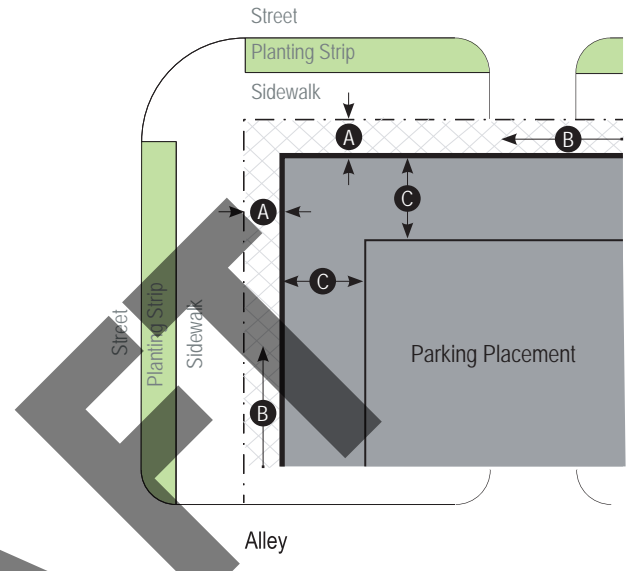

Building Plan

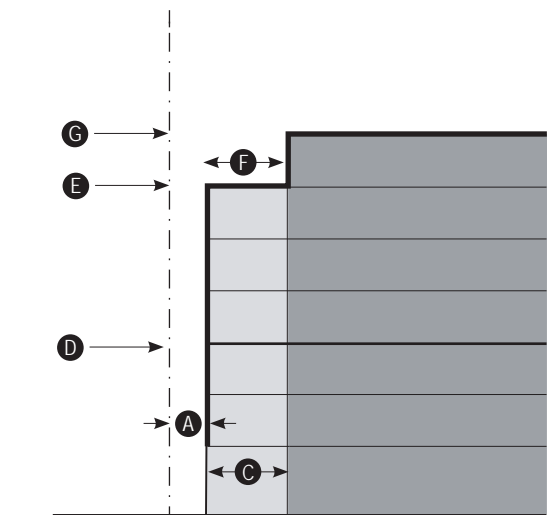

Building Section

Section II: Subdistrict Standards

2nd and Broadway Subdistrict: Building design and Facade articulation

Building design and Facade articulation

- | | |
|---------------------------------------|--|
| L Primary building divisions | 20'-50' wide |
| M Secondary building divisions | 5'-25' wide
Secondary building divisions are defined by solid vertical elements that consist of changes in materials or planes within the facade. |
| N First Floor height | 16' min. |
- Windows**
- O** Ground floor - 60% glazing required from 2 feet above grade to the finished floor of the 2nd story
 - P** Window sill height 18"-24"
- Upper Floors** - Windows shall be vertically oriented at a ratio of 2:1 or greater.

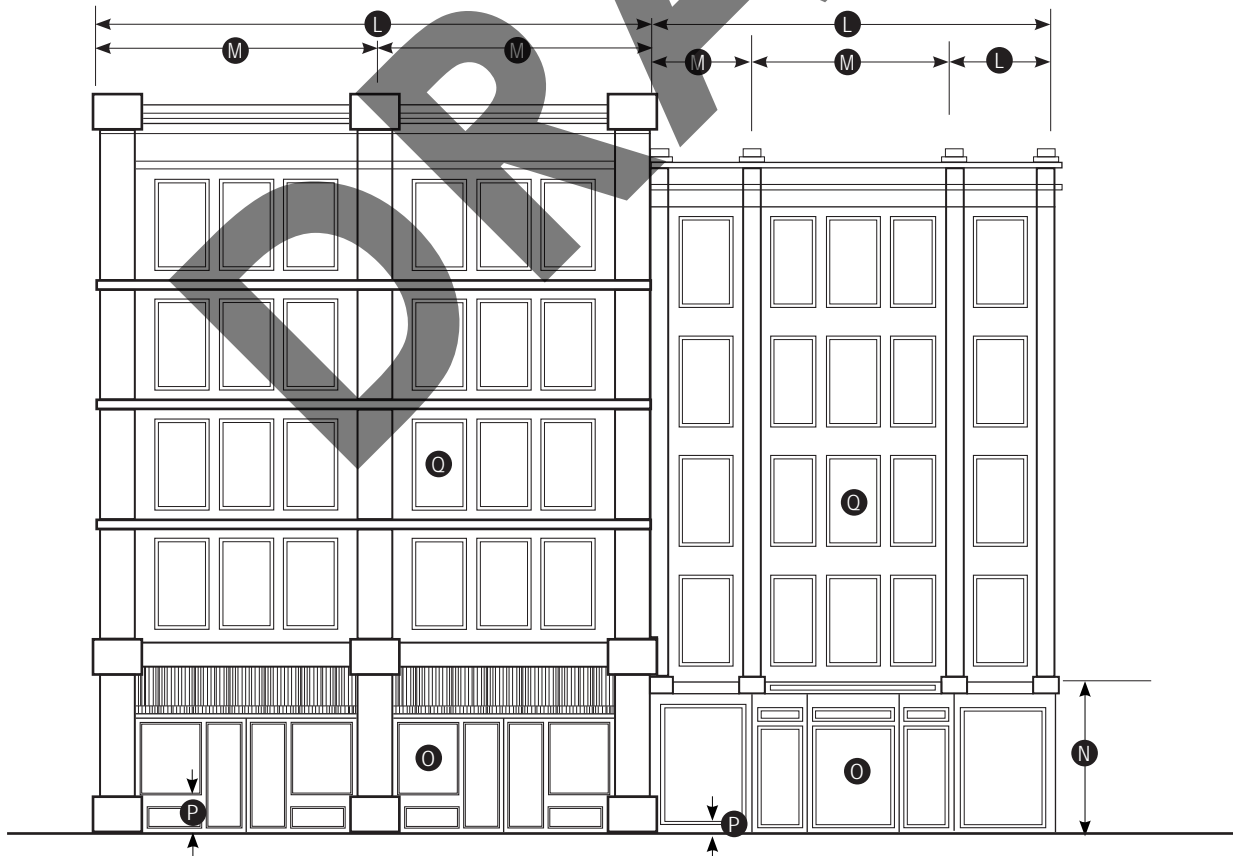

This page left intentionally blank

DRAFT

Section II: Subdistrict Standards

River Subdistrict: Regulating Plan

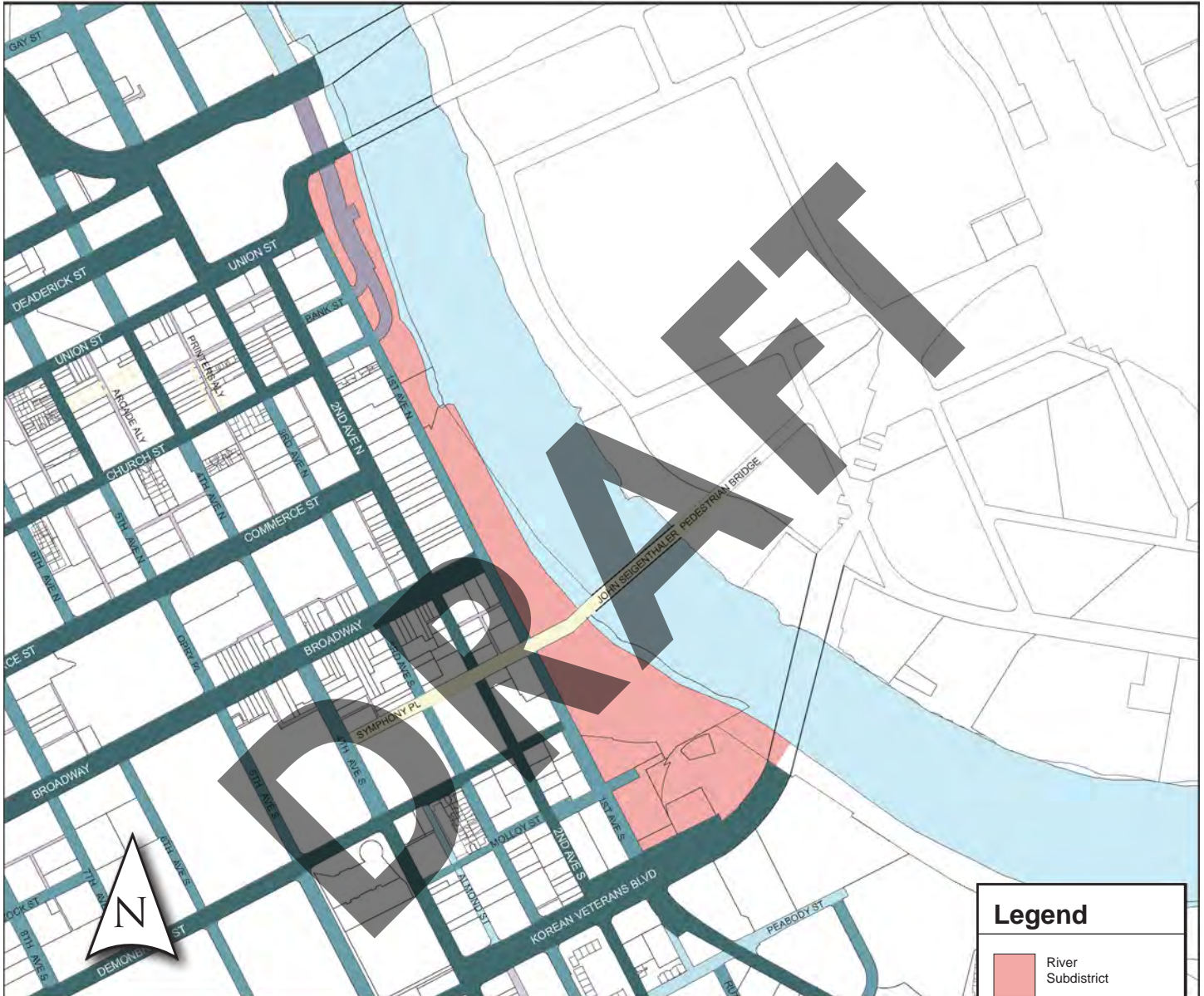

The River subdistrict is a unique area between 1st Avenue South and the Cumberland River. This area is owned by the city and is envisioned to be an amenity for all residents and visitors. New development should be done in conjunction with the Parks Department's *Riverfront Redevelopment Plan* and should treat the river as an amenity while keeping a strong urban edge along 1st Avenue South and the boulevard. The maximum height is low in order to maintain views of the river from many vantage points in Downtown.

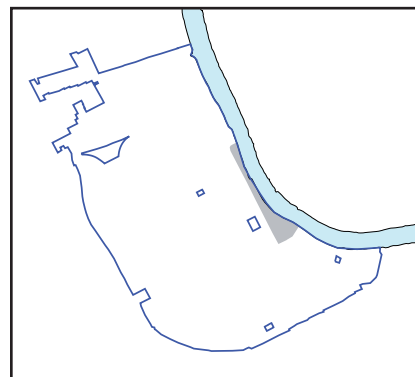

Legend	
	River Subdistrict
	Primary Street
	Secondary Street
	tertiary Street
	Other Street
	Alley
	Pedestrian Frontage

Section II: Subdistrict Standards

River Subdistrict: Building Regulations

Frontage

A Allowed Frontage Types with Required Build-to Zone

Primary Street	
• Storefront Frontage	0'-10'
• Stoop Frontage	5'-10'
Secondary Street	
• Storefront Frontage	0'-10'
• Stoop Frontage	5'-10'
Tertiary Street	
• Storefront Frontage	0'-10'
• Stoop Frontage	5'-15'

B Facade width

Primary Street	80% of lot frontage min.
Secondary Street	80% of lot frontage min.
1st Avenue	70% of lot frontage min.
Tertiary Street	60% of lot frontage min.
Remaining lot frontage may be used for pedestrian amenities and shall not be used for parking.	

C Min. building depth

15' from building facade

Height

D Max.

10 stories

Step-back *

Step-back required for buildings 8 stories or greater on 1st Avenue frontage

E Step-back between

4th and 8th stories

F Min. step-back depth

15'

* see page 61 for full description

Sidewalk & Planting

Improvements to the sidewalk corridor according to the General Standards and the Major and Collector Street Plan.

Notes

Uses: page 55; General Standards: page 59

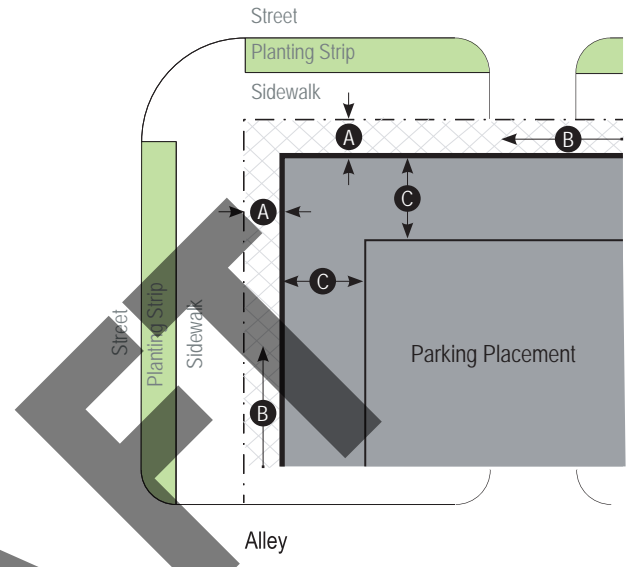

Building Plan

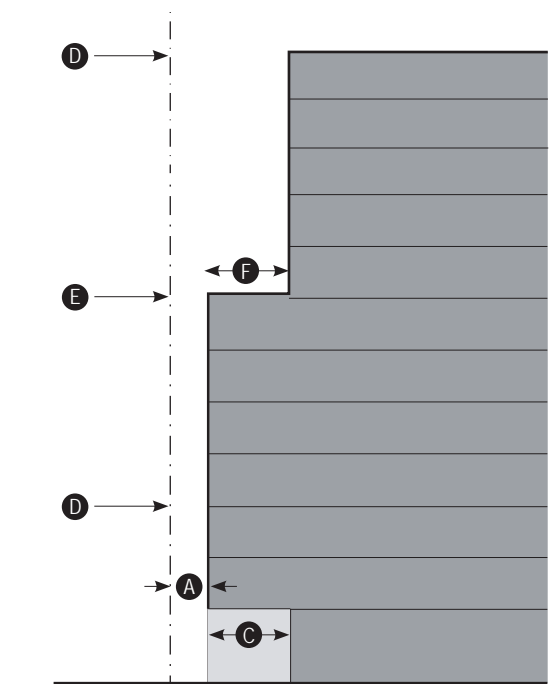

Building Section

Section II: Subdistrict Standards

SoBro Subdistrict: Regulating Plan

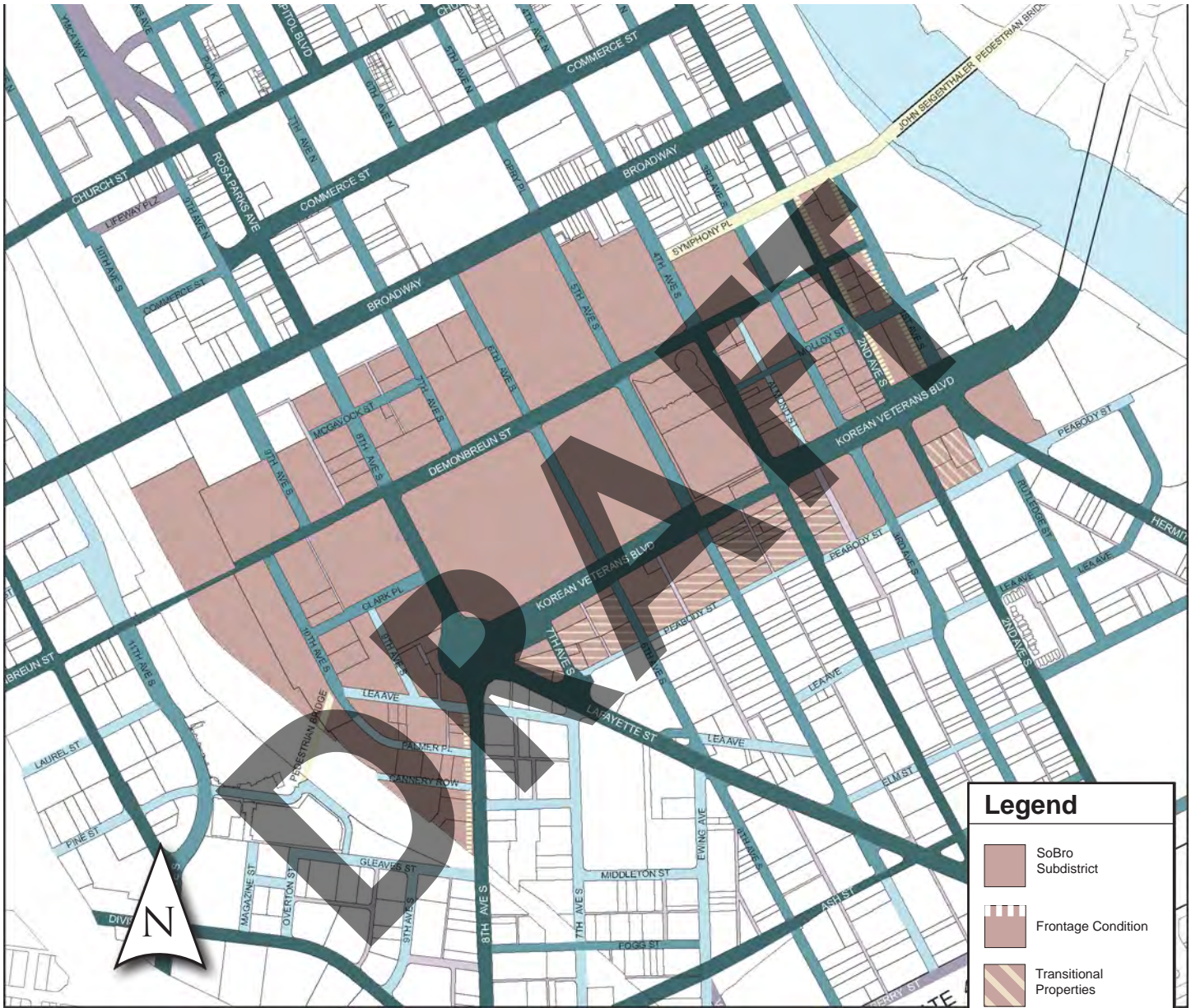

Legend	
	SoBro Subdistrict
	Frontage Condition
	Transitional Properties
	Primary Street
	Secondary Street
	Tertiary Street
	Other Street
	Alley
	Pedestrian Frontage

The SoBro neighborhood is intended to be a high-intensity, mixed-use neighborhood emphasizing cultural and entertainment uses with a mix of residential and office uses. SoBro is an extension of the Core in height and intensity, but it is also a transition to the lower, mid-rise Lafayette neighborhood.

Properties with frontage on the boulevard, and Transitional Properties that consolidate to have frontage on the boulevard, shall be part of the SoBro Subdistrict. Properties south of the boulevard – Transitional Properties – without frontage on the boulevard, shall be part of the Lafayette Subdistrict.

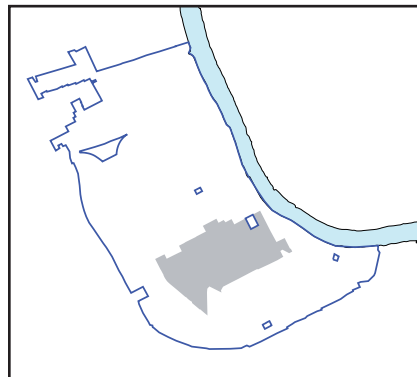

Section II: Subdistrict Standards

SoBro Subdistrict: Building Regulations

Frontage

A Allowed Frontage Types with Required Build-to Zone

Primary Street	
• Storefront Frontage	0'-10'
• Stoop Frontage	5'-10'
Secondary Street	
• Storefront Frontage	0'-10'
• Stoop Frontage	5'-10'
Tertiary Street	
• Storefront Frontage	0'-10'
• Stoop Frontage	5'-15'

B Facade width

Primary Street	80% of lot frontage min.
Secondary Street	80% of lot frontage min.
Tertiary Street	60% of lot frontage min.
Remaining lot frontage may be used for pedestrian amenities and shall not be used for parking.	

C Min. building depth 15' from building facade

Height

D Min.

- On Korean Veterans Boulevard & the roundabout 3 stories or 35'

E Max.

- West side of 1st Ave frontage and east side of 2nd Ave frontage unless fronting KVB 15 stories
 - 8th Avenue frontage, south of the roundabout 8 stories within 100' of 8th Ave; 30 stories beyond 100' of 8th Ave stories
 - Subdistrict general 30 stories
- Additional height available through the Bonus Height Program

Step-back *

- F Step-back between
 - Buildings taller than 7 stories 4th and 8th stories

- G Min. step-back depth 15'

* see page 61 for full description

Notes

- All standards of the Gateway UDO shall apply to development along the boulevard except maximum height at the street, step-back depth, overall height, and floor area ratio. The review process for the DTC and the UDO will be consolidated.
- Uses: page 55; General Standards: page 59

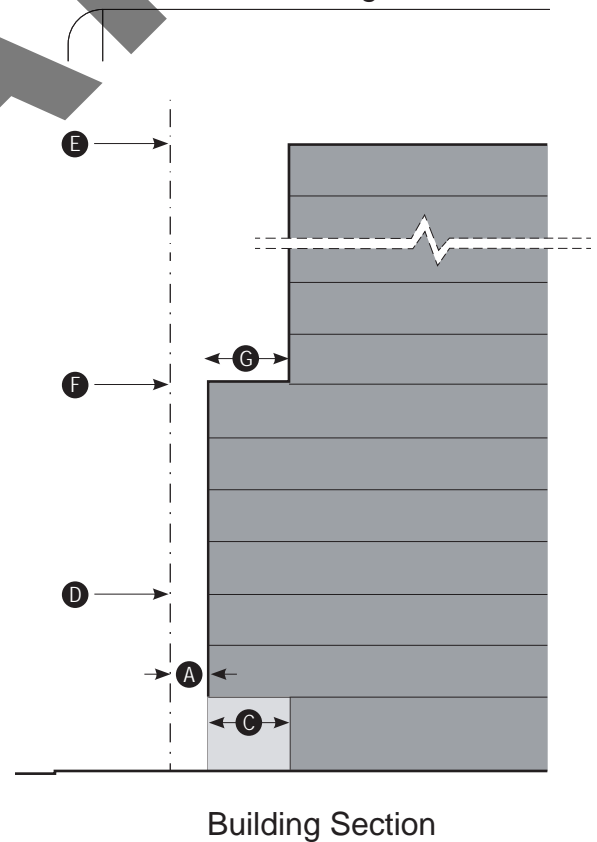
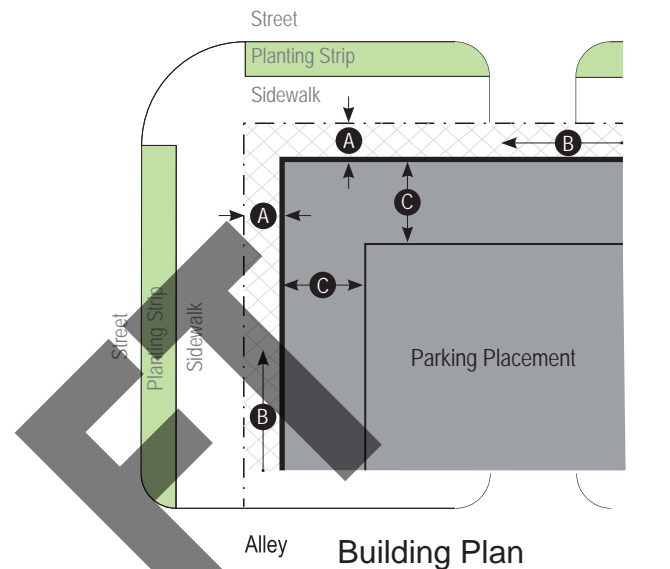

Sidewalk & Planting

Improvements to the sidewalk corridor according to the General Standards and the Major and Collector Street Plan.

Building Regulations - Fronting Roundabout



- Buildings fronting the future roundabout shall respond to the circle with a facade perpendicular to the radius of the roundabout or a curved facade concentric with the roundabout.
- Curvilinear architectural elements such as arcades are encouraged.
- Only Storefront Frontage shall be permitted fronting the roundabout.

Legend

	Primary Street
	Secondary Street
	tertiary Street
	Other Street
	Alley

This page left intentionally blank

DRAFT

Section II: Subdistrict Standards

Lafayette Subdistrict: Regulating Plan



The Lafayette neighborhood is currently a primarily industrial and business services environment with strong transportation connections to the Gulch, SoBro, Midtown, and South Nashville neighborhoods. This neighborhood will likely retain many of the industrial and business service uses while accommodating a greater variety of uses. The neighborhood is primarily low-rise and should act as a transition from the height of the Core and SoBro to the single-family neighborhoods to the South.

Transitional properties that consolidate to have frontage on the boulevard shall be part of the SoBro Subdistrict. Transitional properties that do not consolidate to have frontage on the boulevard shall be part of the Lafayette Subdistrict.

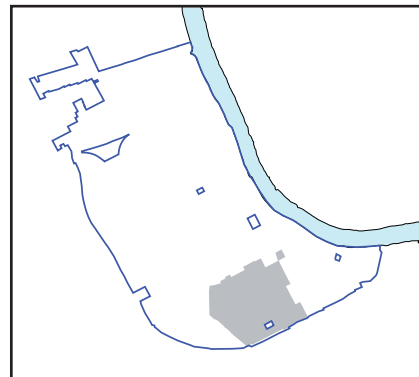

Legend	
	Lafayette Subdistrict
	Transitional Properties
	Primary Street
	Secondary Street
	Tertiary Street
	Other Street
	Alley

Section II: Subdistrict Standards

Lafayette Subdistrict: Building Regulations

Frontage

A Allowed Frontage Types with Required Build-to Zone

Primary Street	
• Storefront Frontage	0'-10'
• Stoop Frontage	5'-10'
Secondary Street	
• Storefront Frontage	0'-10'
• Stoop Frontage	5'-10'
• Porch Frontage	10'-15'
Tertiary Street	
• Storefront Frontage	0'-10'
• Stoop Frontage	5'-10'
• Porch Frontage	10'-15'

Industrial Frontage is allowed in this Subdistrict.

B Facade width

Primary Street	80% of lot frontage min.
Secondary Street	80% of lot frontage min.
Tertiary Street	60% of lot frontage min.

Remaining lot frontage may be used for pedestrian amenities and shall not be used for parking.

C Min. building depth 15' from building facade

Height

D Min.	
• On the roundabout	3 stories or 35'
E Max.	
• Transitional Properties	15 stories
• On Lafayette St	12 stories
• Subdistrict general	8 stories

Additional height available through the Bonus Height Program

Step-back *

Step-back required for all buildings 7 stories or greater fronting public streets

F Step-back between	4th and 7th stories
G Min. step-back depth	15'

* see page 61 for full description

Sidewalk & Planting

Improvements to the sidewalk corridor according to the General Standards and the Major and Collector Street Plan.

Notes

Uses: page 55; General Standards: page 59

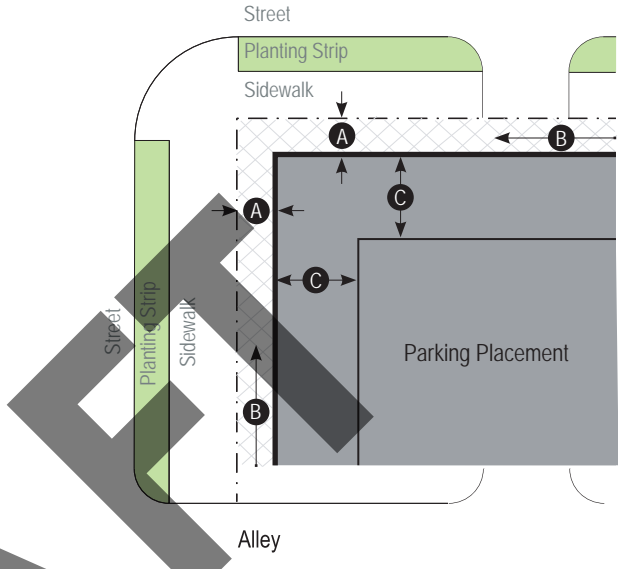

Building Plan

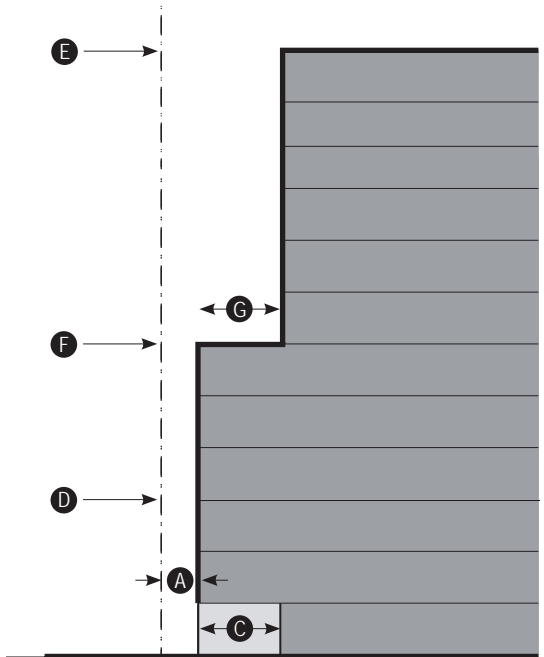

Building Section

Section II: Subdistrict Standards

Rutledge Hill Subdistrict: Regulating Plan

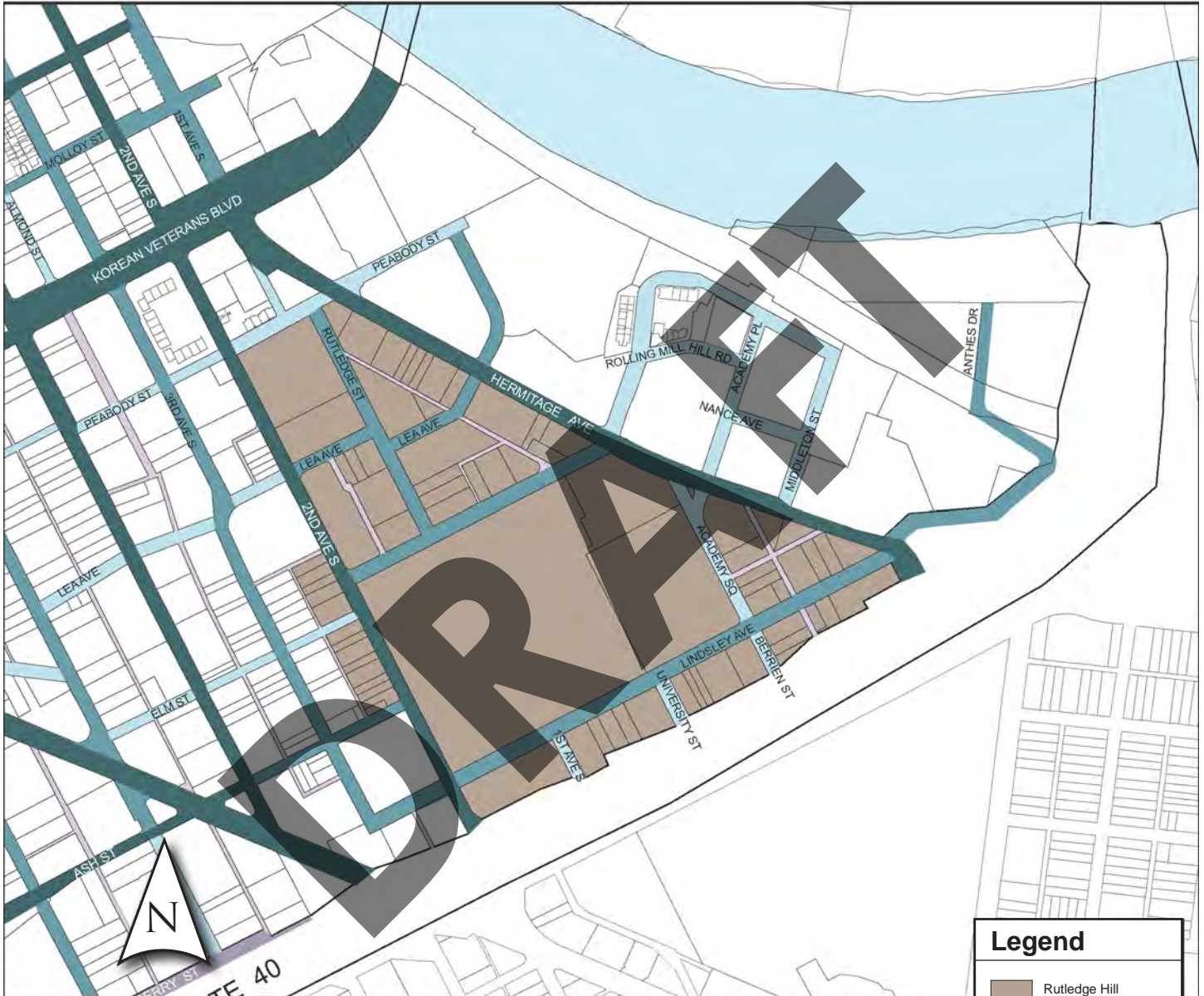

The Rutledge Hill neighborhood includes a variety residential and civic historic buildings. This area is largely intact and new buildings of complimentary height, scale and massing.

Some of these properties are governed by a National Register District that regulates development, restoration and demolition. Property owners must contact the Metro Historic Commission for additional details.

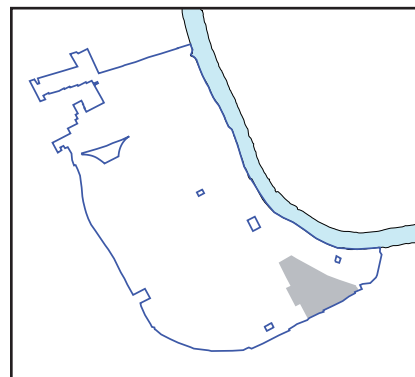

Legend	
	Rutledge Hill Subdistrict
	Rutledge Hill Historic Subdistrict
	Primary Street
	Secondary Street
	Tertiary Street
	Alley

Section II: Subdistrict Standards

Rutledge Hill Subdistrict: Building Regulations

Frontage

A Allowed Frontage Types with Required Build-to Zone

Primary Street	
• Storefront Frontage	0'-10'
• Stoop Frontage	5'-10'
Secondary Street	
• Storefront Frontage	0'-10'
• Stoop Frontage	5'-10'
• Porch Frontage	10'-15'
Tertiary Street	
• Storefront Frontage	0'-10'
• Stoop Frontage	5'-10'
• Porch Frontage	10'-15'

B Facade width

Primary Street	80% of lot frontage min.
Secondary Street	60% of lot frontage min.
Tertiary Street	60% of lot frontage min.
Remaining lot frontage may be used for pedestrian amenities and shall not be used for parking.	

C Min. building depth 15' from building facade

Height

D Max.

• Primary and Secondary streets	6 stories
• Tertiary streets	4 stories
Additional height available through the Bonus Height Program	

Step-back

Step-back required for all buildings fronting public streets

E Step-back after	4 stories
F Min. step-back depth	15'

Sidewalk & Planting

Improvements to the sidewalk corridor according to the General Standards and the Major and Collector Street Plan.

Notes

Uses: page 55; General Standards: page 59

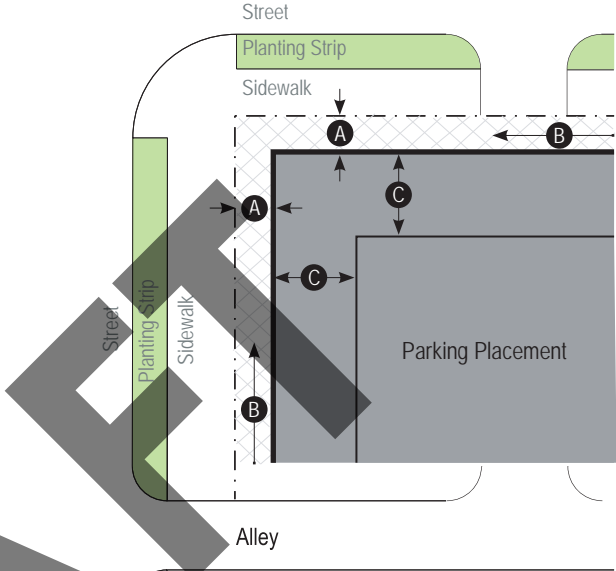

Building Plan

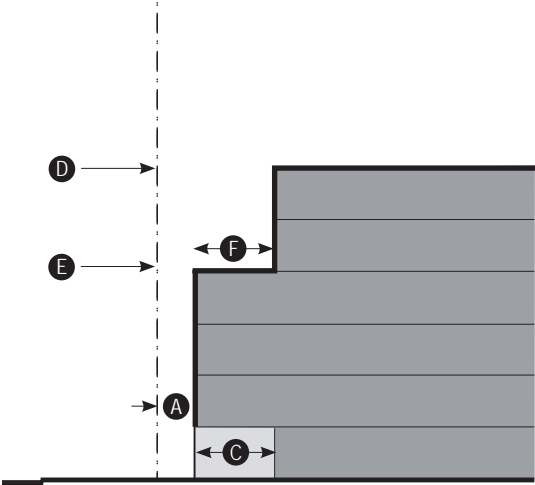

Building Section





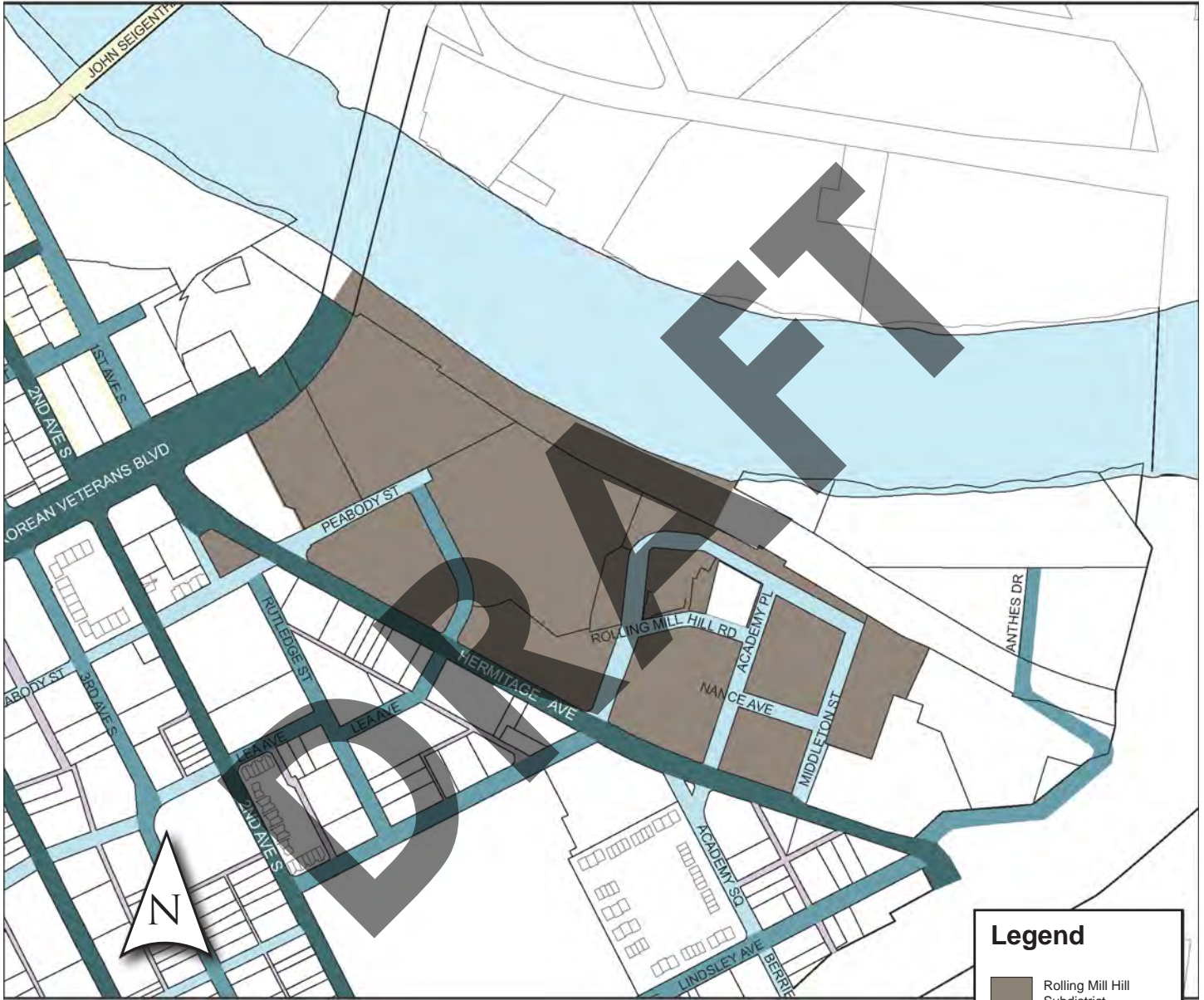

Section II: Subdistrict Standards

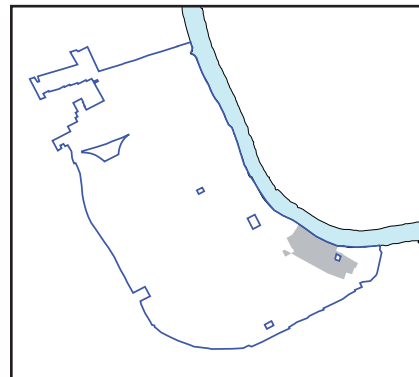
Rolling Mill Hill Subdistrict: Regulating Plan



The redevelopment of the Rolling Mill Hill neighborhood is overseen by the Metropolitan Development and Housing Agency (MDHA) through the *Master Plan and Development Guidelines for Rolling Mill Hill*.



Legend	
	Rolling Mill Hill Subdistrict
	Rolling Mill Hill Historic Subdistrict
	Primary Street
	Secondary Street
	Tertiary Street
	Alley

Section II: Subdistrict Standards

Rolling Mill Hill Subdistrict: Building Regulations

Frontage

A Allowed Frontage Types with Required Build-to Zone

All streets 0-20'

B Facade width

Minimum 25% of the lot frontage or 25', which ever is greater.
Remaining lot frontage may be used for pedestrian amenities and shall not be used for parking.

C Min. building depth 15' from building facade

A building liner is required surrounding parking structures on the ground floor facing public streets and Open Space.

Height

D Max. height at the street 65'

E Height Control Plane

Applies from all streets and Open Space.
1 foot horizontal to 1.5 feet vertical

Sidewalk & Planting

Improvements to the sidewalk corridor according to the General Standards and the Major and Collector Street Plan.

Notes

Uses: page 55; General Standards: page 59

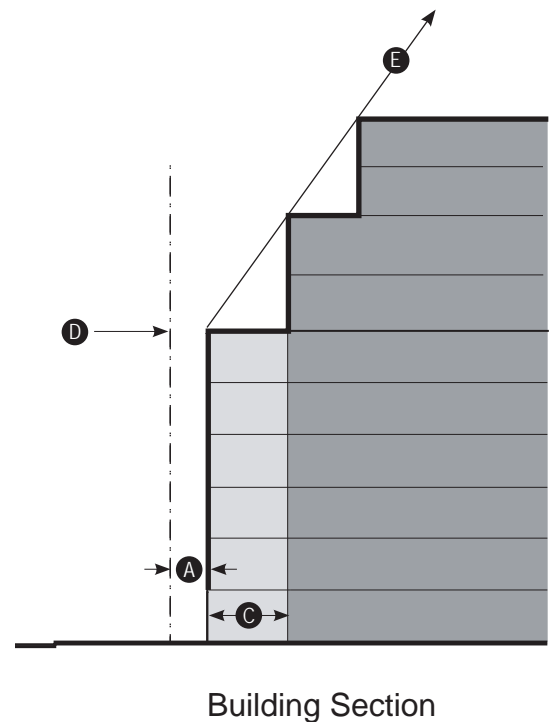
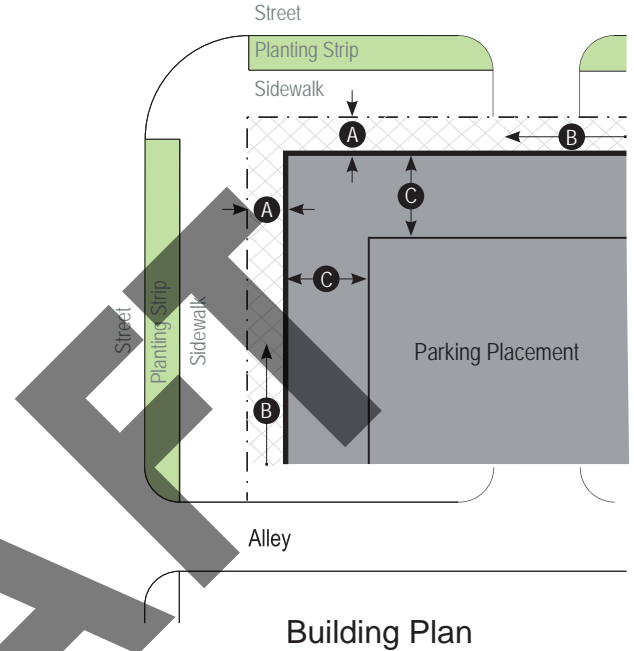

Section II: Subdistrict Standards

Rutledge River Subdistrict: Regulating Plan

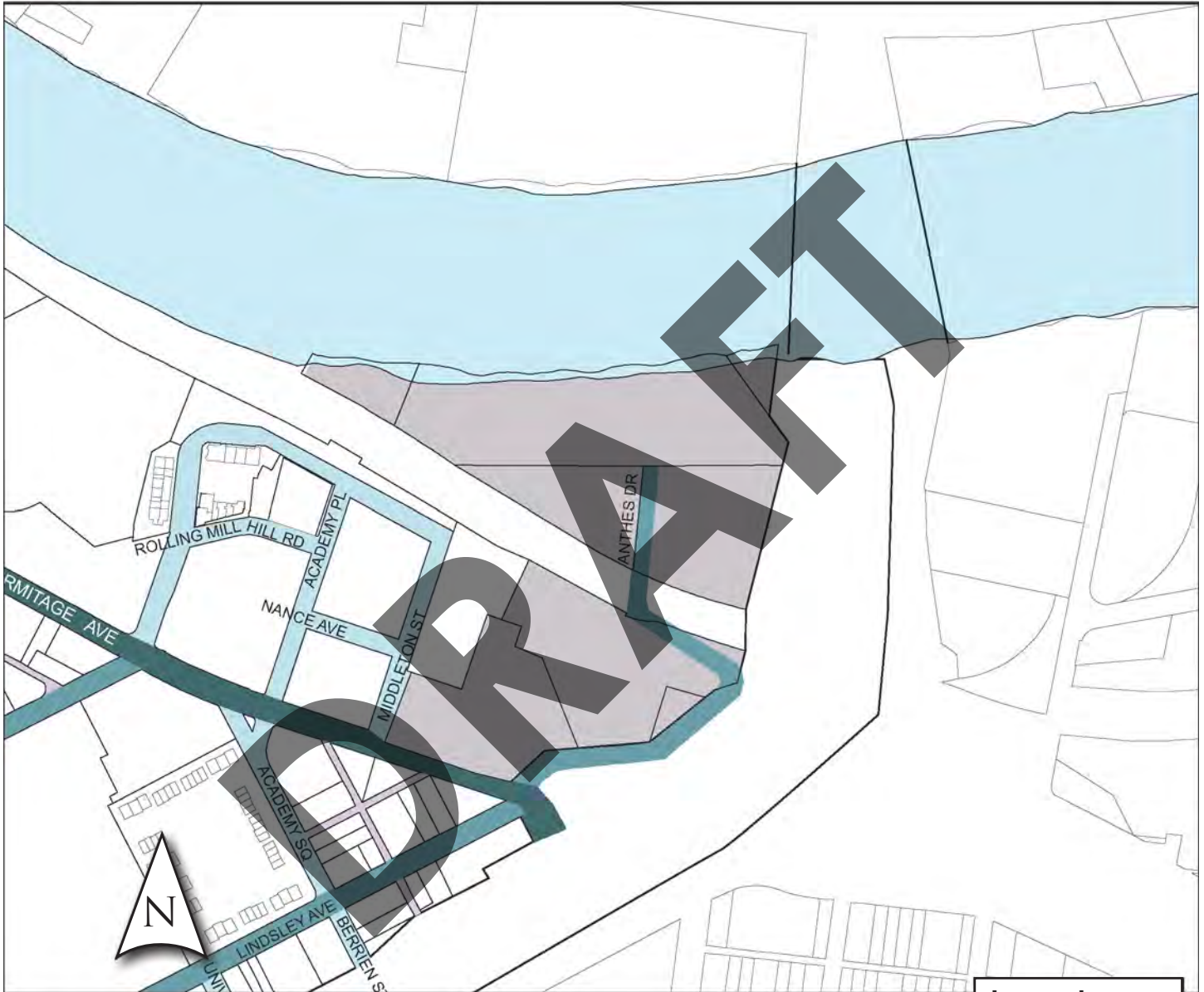

The Rutledge River neighborhood is situated in a somewhat isolated area along the Cumberland River. Redevelopment of this area should make the most of the riverside location and the adjacent commuter rail line, while preserving the historic building on Hermitage Avenue.

New streets within the Rutledge River Subdistrict shall be Secondary or Tertiary Streets.

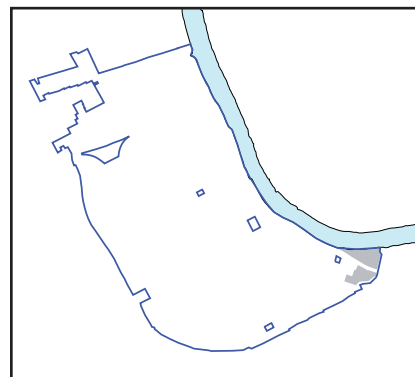

Legend

- Rutledge River Subdistrict
- Primary Street
- Secondary Street
- Tertiary Street
- Alley

Section II: Subdistrict Standards

Rutledge River Subdistrict: Building Regulations

Frontage

A Allowed Frontage Types with Required Build-to Zone

Primary Street	
• Storefront Frontage	0'-10'
• Stoop Frontage	5'-10'
Secondary Street	
• Storefront Frontage	0'-10'
• Stoop Frontage	5'-10'
• Porch Frontage	10'-15'
Tertiary Street	
• Storefront Frontage	0'-10'
• Stoop Frontage	5'-10'
• Porch Frontage	10'-15'

Industrial Frontage is allowed in this Subdistrict.

B Facade width

Primary Street	80% of lot frontage min.
Secondary Street	80% of lot frontage min.
Tertiary Street	60% of lot frontage min.

Remaining lot frontage may be used for pedestrian amenities and shall not be used for parking.

C Min. building depth 15' from building facade

Height

D Max. 9 stories
Additional height available through the Bonus Height Program

Step-back *

Step-back required for all buildings 7 stories or greater fronting public streets

E Step-back between	4th and 7th stories
F Min. step-back depth	15'

* see page 61 for full description

Sidewalk & Planting

Improvements to the sidewalk corridor according to the General Standards and the Major and Collector Street Plan.

Notes

Uses: page 55; General Standards: page 59

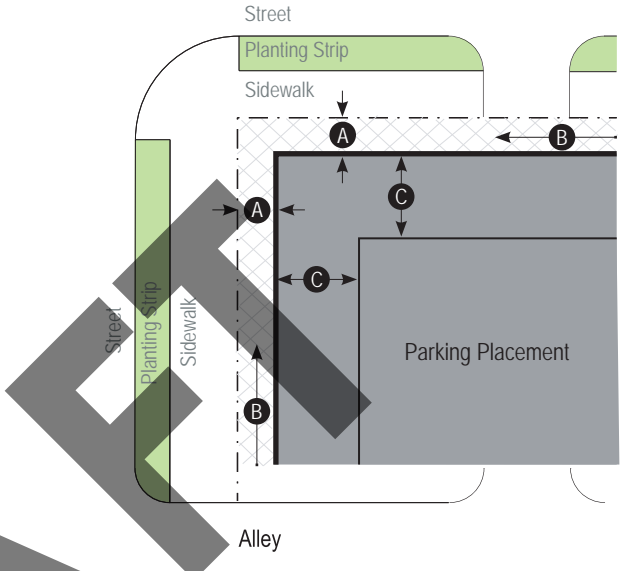

Building Plan

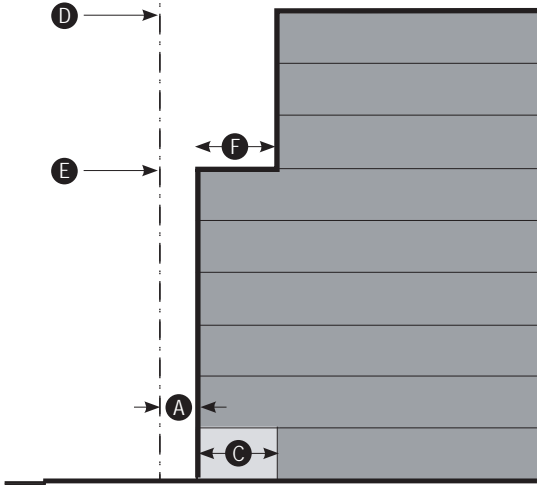

Building Section





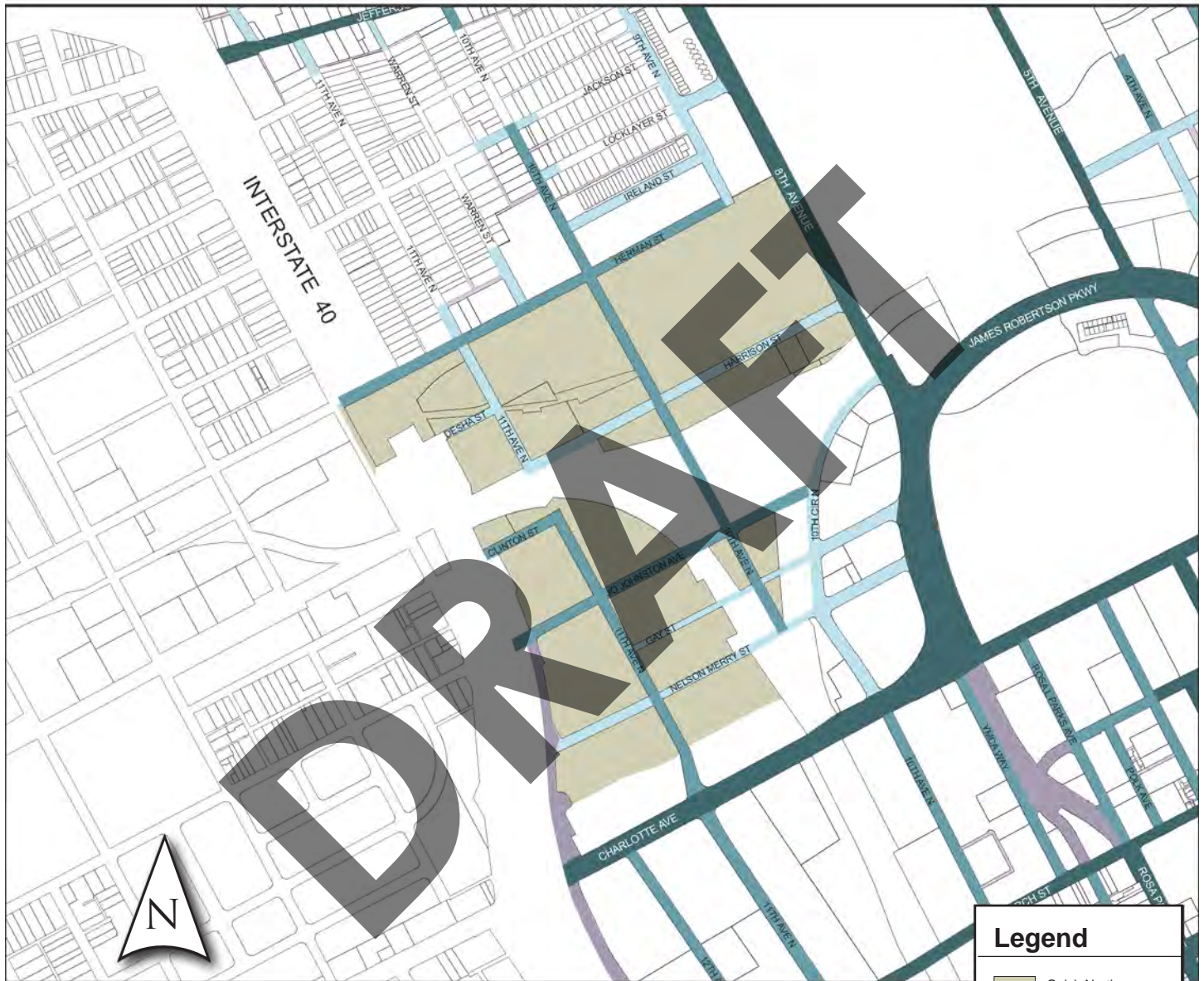

Section II: Subdistrict Standards

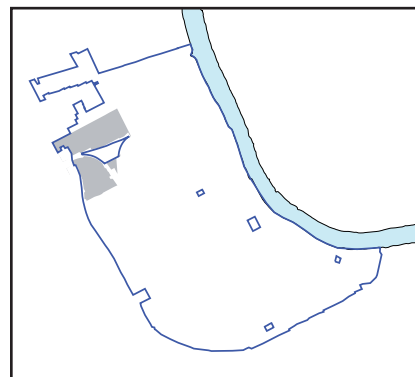
Gulch North: Regulating Plan



The North Gulch neighborhood is an area of transition within Downtown. Bordered on the north and west by single-family residential neighborhoods, on the east by prominent state government landmarks, and on the south by industrial, The North Gulch is envisioned to be a unique area that integrates and harmonizes these diverse uses and building types. Redevelopment of this area should make the most of the existing industrial buildings, interstate access and the internal railroad lines.



Legend	
	Gulch North Subdistrict
	Primary Street
	Secondary Street
	Tertiary Street
	Other Street
	Alley

Section II: Subdistrict Standards

Gulch North: Building Regulations

Frontage

A Allowed Frontage Types with Required Build-to Zone

Primary Street	
• Storefront Frontage	0'-10'
• Stoop Frontage	5'-10'
Secondary Street	
• Storefront Frontage	0'-10'
• Stoop Frontage	5'-10'
• Porch Frontage	10'-15'
Tertiary Street	
• Storefront Frontage	0'-10'
• Stoop Frontage	5'-10'
• Porch Frontage	10'-15'

Industrial Frontage is allowed in this Subdistrict on streets north of Harrison Street, including Harrison Street.

B Facade width

Primary Street	80% of lot frontage min.
Secondary Street	60% of lot frontage min.
Tertiary Street	60% of lot frontage min.

Remaining lot frontage may be used for pedestrian amenities and shall not be used for parking.

C Min. building depth 15' from building facade

Height

- D Max.** 7 stories
- Buildings fronting Herman St 4 stories
- Additional height available through the Bonus Height Program

Sidewalk & Planting

Improvements to the sidewalk corridor according to the General Standards and the Major and Collector Street Plan.

Notes

Uses: page 55; General Standards: page 59

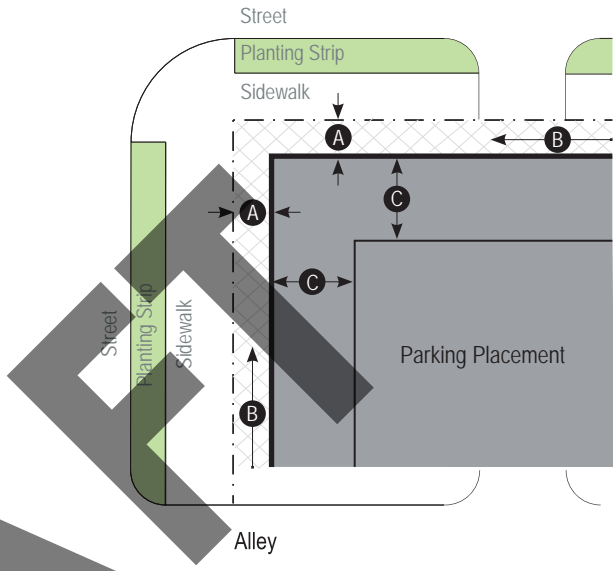

Building Plan

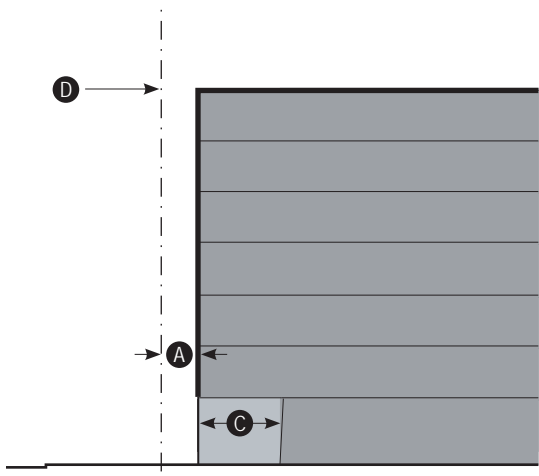

Building Section

Section II: Subdistrict Standards

Gulch South: Regulating Plan

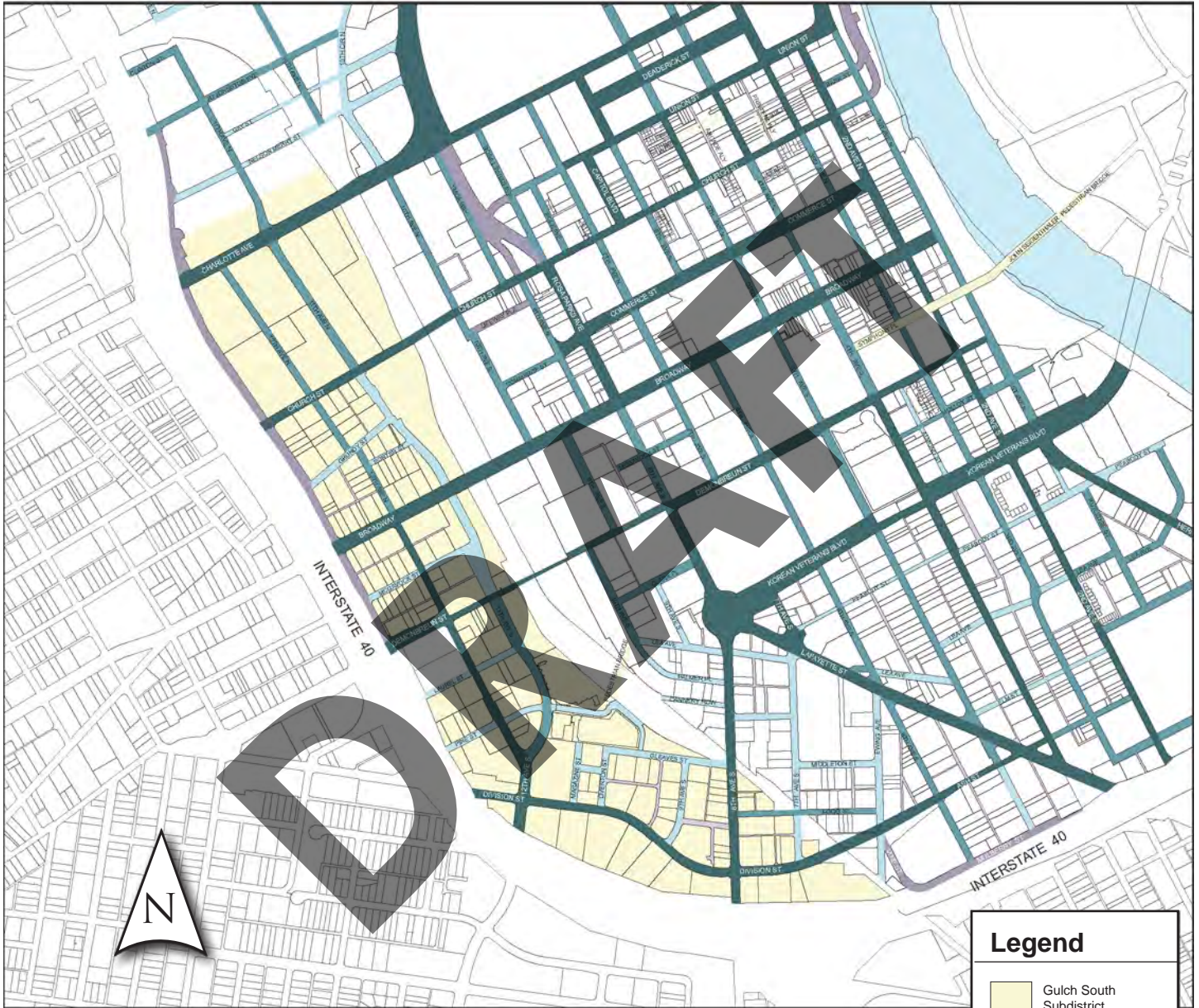

The Gulch South neighborhood is an eclectic neighborhood of business services, restaurant, and retail with many new residential buildings. The area is a link between Downtown and Midtown and is envisioned to be mixed-use mid-rise buildings with opportunities for additional height at key intersections and along important streets. Connectivity – vehicular, rail, bicycle and pedestrian – should be preserved and additional connectivity is strongly encouraged.

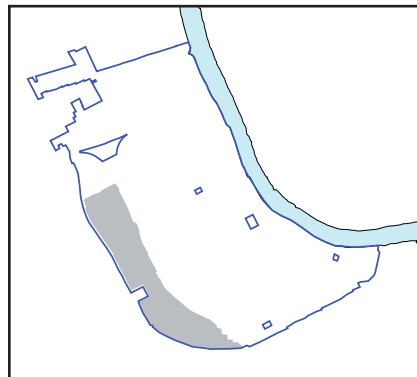

Legend	
	Gulch South Subdistrict
	Primary Street
	Secondary Street
	Tertiary Street
	Other Street
	Alley

Section II: Subdistrict Standards

Gulch South: Building Regulations

Frontage

A Allowed Frontage Types with Required Build-to Zone

Primary Street

- Storefront Frontage 0'-10'
- Stoop Frontage 5'-10'

Secondary and Tertiary Streets

- Storefront Frontage 0'-10'
- Stoop Frontage 5'-10'
- Porch Frontage 10'-15'

Facade width

- Primary Street 80% of lot frontage min.
- Secondary Street 80% of lot frontage min.
- Tertiary Street 60% of lot frontage min.

- B Remaining lot frontage may be used for pedestrian amenities and shall not be used for parking.

Min. building depth 15' from building facade

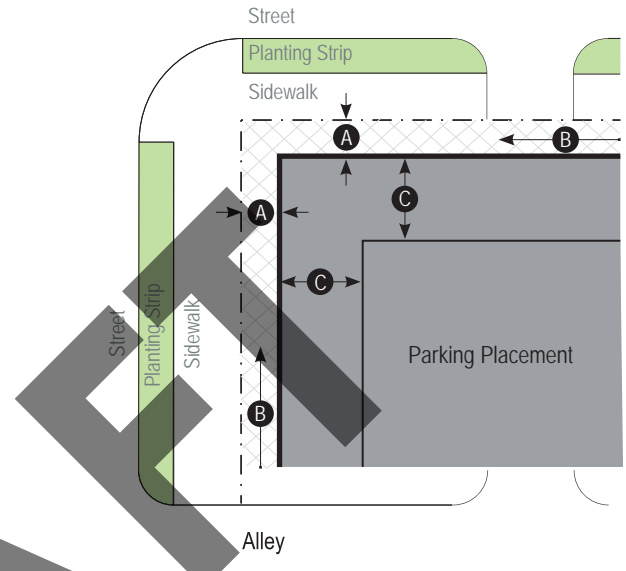

Height

C Max.

- On Church St, Broadway, Demonbreun 15 stories
- At the intersection of 12th Ave and Broadway, 12th and Demonbreun, 12th Ave and Division, 8th Ave and Division 20 stories

D

- Subdistrict general 10 stories

Additional height at intersections applies to frontage within 150 feet of the intersection. The distance from street intersections shall be measured from the nearest intersection of the existing right-of-way lines or extensions thereof. For streets designated to be widened at a future time by the adopted MCSP, measurement shall be made from the ultimate right-of-way.

Additional height available through the Bonus Height Program

Step-back *

Step-back required for buildings 8 stories or greater along public streets

- E Step-back between 4th and 8th stories
- F Min. step-back depth 15'

* see page 61 for full description

Sidewalk & Planting

Improvements to the sidewalk corridor according to the General Standards and the Major and Collector Street Plan.

Notes

Uses: page 55; General Standards: page 59

Building Plan

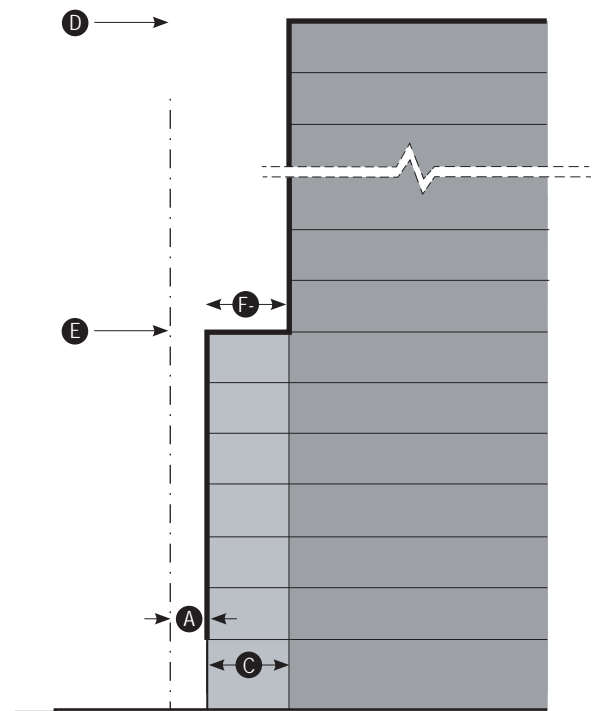

Building Section

Section II: Subdistrict Standards

Hope Gardens Subdistrict: Regulating Plan



The Hope Gardens subdistrict includes the commercial and multi-family areas surrounding the single-family residential at the center of the Hope Gardens neighborhood. Development along the major streets – Jefferson Street and Rosa Parks Boulevard – should be low-rise and should transition in height and mass near the single-family areas. The existing commercial, residential and industrial uses are all important factors within this area and can be maintained while providing opportunities for mixed-use. The harmonization of these many uses – through the regulation of the building forms – will ensure the vitality of this mixed-use neighborhood.

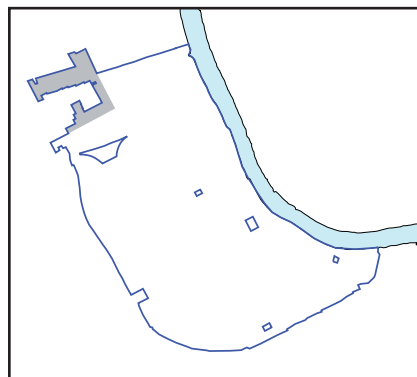

Section II: Subdistrict Standards

Hope Gardens Subdistrict: Building Regulations

Frontage

A Allowed Frontage Types with Required Build-to Zone

Primary Street	
• Storefront Frontage	0'-10'
• Stoop Frontage	5'-10'
Secondary Street	
• Storefront Frontage	0'-10'
• Stoop Frontage	5'-10'
• Porch Frontage	10'-15'
Tertiary Street	
• Storefront Frontage	0'-10'
• Stoop Frontage	5'-10'
• Porch Frontage	10'-15'

Industrial Frontage is allowed in this Subdistrict along Herman Street only.

B Facade width

Primary Street	80% of lot frontage min.
Secondary Street	60% of lot frontage min.
Tertiary Street	60% of lot frontage min.

Remaining lot frontage may be used for pedestrian amenities and shall not be used for parking.

C Min. building depth

15' from building facade

A building liner is required surrounding parking structures on the ground floor facing public streets and Open Space.

Height

D Max.

• Primary Street	7 stories
• Secondary Street	4 stories
• Tertiary Street	3 stories

Additional height available through the Bonus Height Program

Step-back

Step-back required for properties abutting the single family neighborhood. Step-back shall be measured from the abutting property line.

E Step-back required after	3 stories
F Minimum step-back depth	30'

Buffer

Landscape buffer

A landscaped buffer in accordance with 17.24.240 B-5 shall be required along any property line directly abutting a single or two-family zone district.

Notes

Uses: page 55; General Standards: page 59

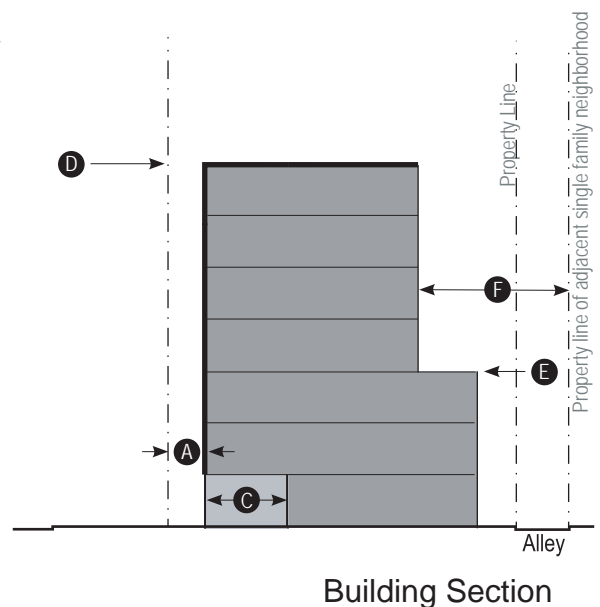
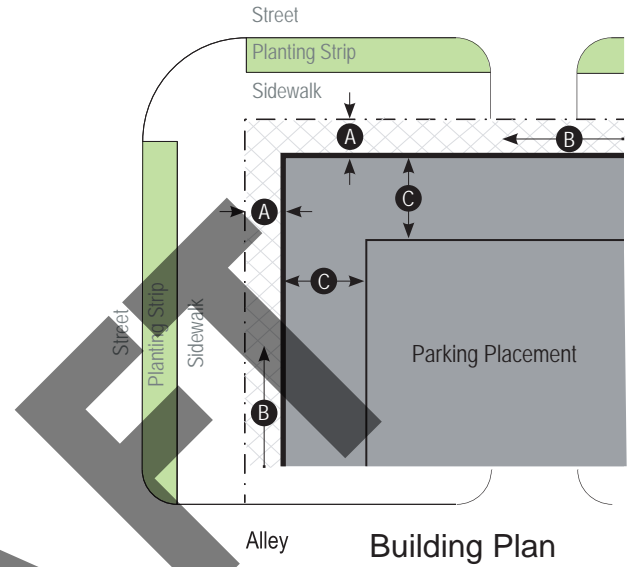

Sidewalk & Planting

Improvements to the sidewalk corridor according to the General Standards and the Major and Collector Street Plan.





Section II: Subdistrict Standards

Sulphur Dell: Regulating Plan

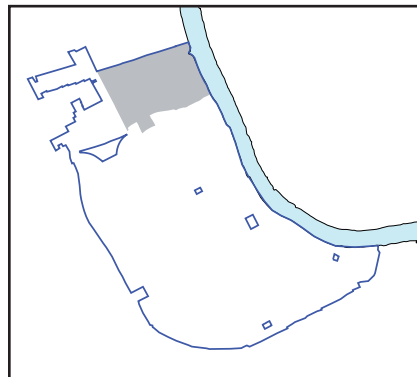

The Sulphur Dell neighborhood is a mixed-use neighborhood surrounding the Bicentennial Mall on the north side of Downtown. This area includes many state-owned properties and is envisioned to be a cultural and civic destination within the State. Mixed-use and residential buildings will diversify the neighborhood and provide a transition in height and use into neighborhoods to the north.



Legend	
	Sulphur Dell Subdistrict
	Primary Street
	Secondary Street
	Tertiary Street
	Alley

Section II: Subdistrict Standards

Sulphur Dell Subdistrict: Building Regulations

Frontage

A Allowed Frontage Types with Required Build-to Zone

Primary Street	
• Storefront Frontage	0'-10'
• Stoop Frontage	5'-10'
Secondary Street	
• Storefront Frontage	0'-10'
• Stoop Frontage	5'-10'
• Porch Frontage	10'-15'
Tertiary Street	
• Storefront Frontage	0'-10'
• Stoop Frontage	5'-10'
• Porch Frontage	10'-15'

B Facade width

Primary Street	80% of lot frontage min.
Secondary Street	80% of lot frontage min.
Tertiary Street	60% of lot frontage min.
Remaining lot frontage may be used for pedestrian amenities and shall not be used for parking.	

C Min. building depth 15' from building facade

Height

D Max.

• Primary Street	7 stories
• Secondary Street	5 stories
• Tertiary Street	4 stories
Additional height available through the Bonus Height Program	

Sidewalk & Planting

Improvements to the sidewalk corridor according to the General Standards and the Major and Collector Street Plan.

Notes

Uses: page 55; General Standards: page 59

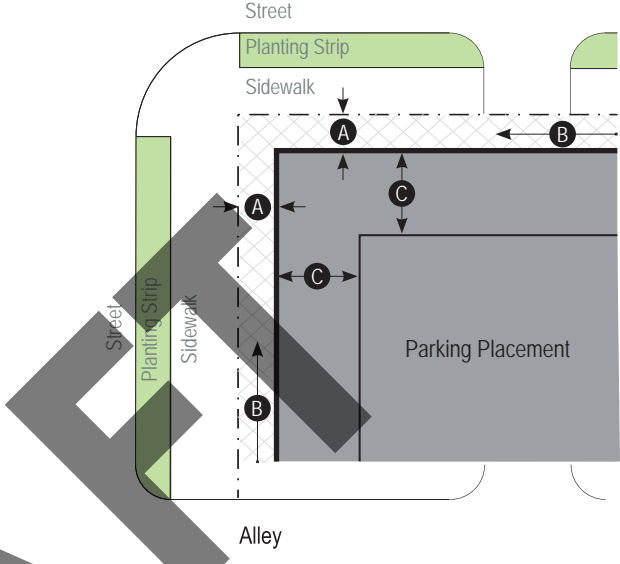

Building Plan

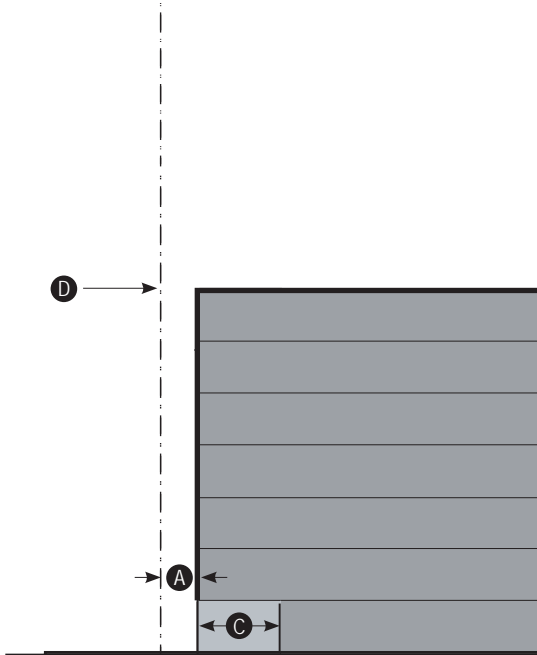

Building Section

This page left intentionally blank

DRAFT

Section III: Uses

DRAFT

Section III: Uses

Use Areas

Land uses within the DTC are determined by Area – Central, South, West, and North. To create a sustainable and mixed-use Downtown, the form-based zoning of each subdistrict regulates the shape, scale, and placement of the buildings, and allows a variety of uses. Use Area boundaries are the same as Subdistrict boundaries. To determine the allowed land uses, locate the property on the Area Plan, and refer to the Area column on the Land Use Chart for the allowed uses.

In the event of a conflict between the following Land Use Chart and the Zoning District Land Use Table within Chapter 17.08, the Zoning District Land Use Table shall apply. Uses Permitted with Conditions or Permitted by Special Exceptions or Accessory shall follow the standards of Chapter 17.16. If standards within Chapter 17.16 and the DTC conflict, the stricter shall apply.

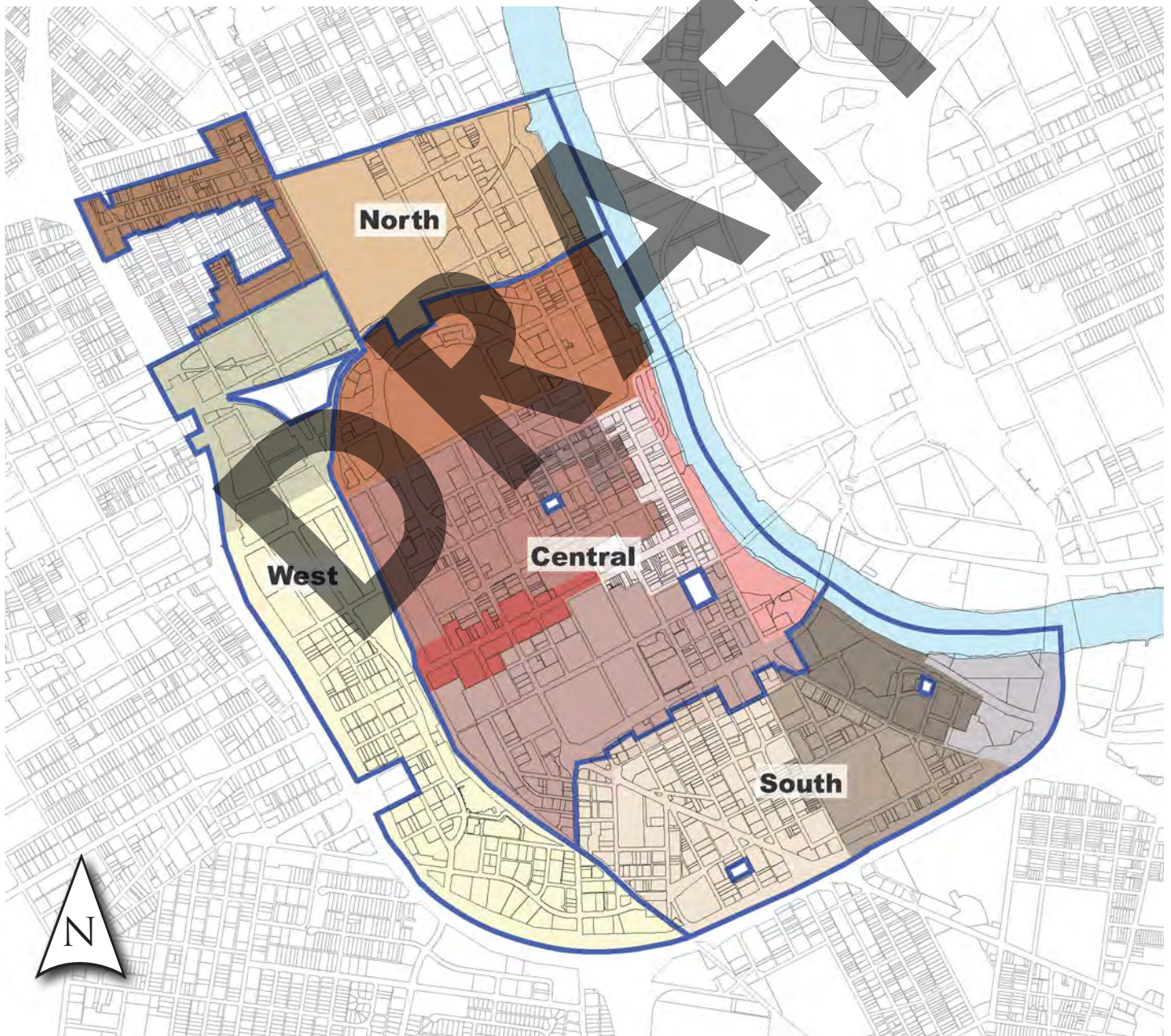

Section III: Uses

Use Tables

P	Permitted by right	North	South	West	Central
PC	Permitted with conditions				
SE	Special Exception				
A	Accessory				
O	Overlay District				

P	Permitted by right	North	South	West	Central
PC	Permitted with conditions				
SE	Special Exception				
A	Accessory				
O	Overlay District				

Residential Uses:					
Single-family	P	P	P	P	P
Two-family	P	P	P	P	P
Multi-family	P	P	P	P	P
Elderly housing	P	P	P	P	P
Mobile home dwelling					
Accessory apartment	P	P	P	P	P
Accessory dwelling, detached					
Boarding house	P	P	P	P	P
Consignment sale	P	P	P	P	P
Domesticated hens					
Garage sale	A	A	A	A	A
Historic bed and breakfast homestay	P	P	P	P	P
Historic home events	P	P	P	P	P
Home occupation	P	P	P	P	P
Rural bed and breakfast homestay					
Security residence					
Short term rental property (STRP)—Owner	A	A	A	A	A
Institutional Uses:					
Correctional facility	P	P	P	P	P
Cultural center	P	P	P	P	P
Day care center (Up to 75)	P	P	P	P	P
Day care center (Over 75)	P	P	P	P	P
Day care home	P	P	P	P	P
Day care—Parent's day out	A	A	A	A	A
School day care	P	P	P	P	P
Monastery or convent	P	P	P	P	P
Orphanage	P	P	P	P	P
Religious institution	P	P	P	P	P
Educational Uses:					
Business school	P	P	P	P	P
College or university	P	P	P	P	P
Community education	P	P	P	P	P
Dormitory	P	P	P	P	P
Fraternity/sorority house	P	P	P	P	P
Personal instruction	P	P	P	P	P
Vocational school	P	P	P	P	P
Office Uses:					
Alternative financial services					
Financial institution	P	P	P	P	P
General office	P	P	P	P	P
Leasing/sales office	P	P	P	P	P
Other Uses:					
Agricultural activity					
Cemetery	P	P	P	P	P
Domestic animals/wildlife					
Mineral extraction					
On-site agricultural sales					
Pond/lake	P	P	P	P	P

Commercial Uses:					
Animal boarding facility	P	P	P	P	P
ATM	P	P	P	P	P
Auction house	P	P	P	P	P
Automobile convenience	PC	PC	PC	PC	PC
Automobile parking	P	P	P	P	P
Automobile repair		PC			
Automobile sales, new		P	P	P	P
Automobile sales, used					
Automobile service	P	P	P	P	P
Bar or nightclub	P	P	P	P	P
Bed and breakfast inn	P	P	P	P	P
Beer and cigarette market	P	P	P	P	P
Boat storage					
Business service	P	P	P	P	P
Carpet cleaning	P	P	P	P	P
Car wash		PC			
Community gardening (commercial)	P	P	P	P	P
Community gardening (noncommercial)	P	P	P	P	P
Custom assembly	P	P	P	P	P
Donation center, drop-off	PC	PC	PC	PC	PC
Flea market	P	P	P	P	P
Funeral home	P	P	P	P	P
Furniture store	P	P	P	P	P
Grocery store	P	P	P	P	P
Home improvement sales	P	P	P	P	P
Hotel/motel	P	P	P	P	P
Inventory stock	A	A	A	A	A
Kenel/stable					
Laundry plants		P	P		
Liquor sales	P	P	P	P	P
Major appliance repair	P	P	P	P	P
Mobile storage unit	PC	PC	PC	PC	PC
Mobile vendor					
Nano brewery					
Personal care services	P	P	P	P	P
Restaurant, fast-food	P	P	P	P	P
Restaurant, full-service	P	P	P	P	P
Restaurant, take-out	P	P	P	P	P
Retail	P	P	P	P	P
Self-service storage	P	P	P	P	P
Short term rental property (STRP)—Not owner	PC	PC	PC	PC	PC
Vehicular rental/leasing	PC	PC	PC	PC	PC
Vehicular sales and service, limited		P			
Wrecker service		P			

Section III: Uses

Use Tables

P	Permitted by right	North	South	West	Central
PC	Permitted with conditions				
SE	Special Exception				
A	Accessory				
O	Overlay District				

P	Permitted by right	North	South	West	Central
PC	Permitted with conditions				
SE	Special Exception				
A	Accessory				
O	Overlay District				

Medical Uses:					
Animal hospital					
Assisted-care living	P	P	P	P	P
Hospice	P	P	P	P	P
Hospital	P	P	P	P	P
Medical appliance sales	P	P	P	P	P
Medical office	P	P	P	P	P
Medical or scientific lab	P	P	P	P	P
Nonresidential drug treatment facility	P	P	P	P	P
Nursing home	P	P	P	P	P
Outpatient clinic	P	P	P	P	P
Rehabilitation services	P	P	P	P	P
Residence for handicapped, more than eight	P	P	P	P	P
Veterinarian	P	P	P	P	P
Communication Uses:					
Amateur radio antenna	P	P	P	P	P
Audio/video tape transfer	P	P	P	P	P
Communications hut	PC	PC	PC	PC	PC
Multi-media production	P	P	P	P	P
Printing and publishing	P	P	P	P	P
Radio/TV studio	P	P	P	P	P
Satellite dish	P	P	P	P	P
Telecommunication facility	PC	PC	PC	PC	PC
Industrial Uses:					
Artisan distillery	P	P	P	P	P
Asphalt plant					
Building contractor supply	PC	PC	PC		
Compressor station					
Concrete plant					
Distributive business/wholesale	PC	PC	PC		
Fuel storage	A	A	A		
Heavy equipment, sales and service					
Hazardous operation					
Manufacturing, Artisan	PC	PC	PC		
Manufacturing, heavy					
Manufacturing, medium					
Manufacturing, light	PC	PC	PC		
Microbrewery	P	P	P	P	P
Research service	P	P	P		
Scrap operation					
Tank farm					
Tasting room					
Warehouse	PC	PC	PC		
Waste Management Uses:					
Collection center					
Construction/demolition landfill					
Construction/demolition waste processing (project)	PC	PC	PC	PC	PC
Medical waste	A	A	A	A	A
Recycling collection center	P	P	P	P	P
Recycling facility					
Sanitary landfill					
Waste transfer					

Transportation Uses:					
Airport, medium or large commercial service					
Airport/heliport					
Boat dock (commercial)	P	P			P
Bus station/landport	P	P	P	P	P
Bus transfer station	P	P	P	P	P
Commuter rail	P	P	P	P	P
Helistop	SE	SE	SE	SE	SE
Motor freight					
Park and ride lot					
Railroad station	SE	SE	SE		
Railroad yard					
Water taxi station	P	P			P
Utility Uses:					
Power/gas substation	P	P	P	P	P
Power plant	A	A	A	A	A
Reservoir/water tank	P	P	P	P	P
Safety services	P	P	P	P	P
Waste water treatment	SE	SE	SE	SE	SE
Water/sewer pump station	P	P	P	P	P
Water treatment plant	SE	SE	SE	SE	SE
Wind energy facility (small)	PC	PC	PC	PC	PC
Wind energy facility (utility)					
Recreation and Entertainment Uses:					
Adult entertainment	O	O	O	O	O
After hours establishment	PC	PC	PC	PC	PC
Camp					
Club	P	P	P	P	P
Commercial amusement (inside)					
Commercial amusement (outside)	P	P	P	P	P
Country club	P	P	P	P	P
Drive-in movie					
Driving range					
Fairground					
Golf course					
Greenway	P	P	P	P	P
Park	P	P	P	P	P
Racetrack					
Recreation center	P	P	P	P	P
Rehearsal hall	P	P	P	P	P
Sex club					
Small outdoor music event					
Stadium arena/convention center	P	P	P	P	P
Temporary festival	P	P	P	P	P
Theater	P	P	P	P	P
Theatre					
Zoo					

Section IV: General Standards

DRAFT

This page left intentionally blank

DRAFT

Section IV: General Standards

Calculations

Measurement from “Grade”

- Unless otherwise indicated, reference to measurements from “grade” shall be calculated using the average elevation along the public right-of-way fronting the property. Thus, grade will generally be measured from the public sidewalk, not from grade on site.
- When buildings are set back from the property line more than 15 feet, grade shall be measured as the average existing elevation at the building facade.
- In the event that the base flood elevation, as established by FEMA, is higher than the sidewalk or grade elevations, the height of the first story, shall be measured from 1 foot above the base flood elevation.
- The minimum ground floor height for all frontage types is 14 feet from grade.

Measurement of Height

- Unless otherwise specified herein, the height of buildings shall be measured in stories.
- The maximum height for an individual story shall not exceed 25 feet from finished floor to finished floor for each of the first 2 stories, 18 feet floor to floor above the second story, and 25 feet for the top story of buildings greater than 5 stories.
- The minimum building height shall be 25 feet. This applies to all buildings except those designed for single-family use, two-family use, or multi-family use with residential on the ground floor.
- The maximum height for a raised foundation is 6 feet above grade.
- Basements are not considered stories for the purposes of determining building height.
- Building height shall be measured from each Street Frontage (excluding Other streets alleys) or Open Space.
- The height of a parking structure concealed by a building liner may be equal to the height of the liner, regardless of the number of stories. If there is no liner to conceal the parking structure, its height is limited by the maximum number of stories allowed.
- The height of fences, walls and hedges shall be measured in feet from the average sidewalk elevation.

Step-backs

- If a building step-back is specified to occur between a range of stories, that range shall include the lower and upper story bounds. For example, the James Robertson Subdistrict specifies a 15’ step-back between the 4th and 8th stories. Therefore the required stepback can occur on the 4th, 5th, 6th, 7th, or 8th story.
- To allow for facade variation, stories within the range may be permitted to step-back to a lesser extent or not at all, so long as the minimum step-back depth is met by the upper story bound of the required step-back range.

Fenestration and Glazing

- Except as specifically referenced herein, façade glazing and opening standards shall include windows, doors and openings in parking structures and shall apply to all areas of the building façade facing a public street or open space (excluding Other streets and alleys) as follows:
 - First Floor: façade area measured from the finished floor to a height 14 feet above the finished floor.
 - Upper Floors: façade area from finished floor to finished floor.
 - Openings for vehicular access to parking structures on the first floor shall not be included in calculation of total façade area or glazed area.
 - The DTC recognizes the need for building systems and functionality including interior mechanical systems, fire safety egress, other building code issues and their impact of the feasibility of building fenestration. Areas of the façade affected by these elements shall not be counted toward minimum glazing requirements.

Section IV: General Standards

Street Character

The public right-of-way, including streets, sidewalks and public utility infrastructure, plays both a functional and social role in the life of the city and its citizens. Streets organize the city, help to define space, and link destinations. The street is also a public place where people congregate, shop, socialize and live. Active, attractive streets are critical to the continued growth and success of Downtown. The DTC includes urban design tools to make working, living and playing in Downtown lively, safe and comfortable.

The DTC uses Street Types as an urban design and organizing tool. All streets are classified on the Regulating Plan as Primary, Secondary, Tertiary, Other, or Alley.

Where alleys exist and are in working condition, or where new alleys can be created, the DTC prioritizes alleys for access and loading. The location of vehicular access from all other streets shall be determined on a case-by-case basis.

The Downtown Plan: 2007 Update calls for “a strong emphasis on expanding other modes of transportation including walking, cycling and transit.” The DTC emphasizes walking, cycling and transit as primary modes of transportation within Downtown through the urban design of individual buildings, blocks, and neighborhoods.

All Streets

- Streets refer to publicly or privately owned right-of-way. They are intended for use by pedestrian, bicycle, transit and vehicular traffic and provide access to property.
- Streets consist of vehicular lanes and the Sidewalk Corridor. The vehicular lanes, in a variety of widths, provide traffic and parking capacity and may include bicycle paths. The Sidewalk Corridor contributes to the urban character of each neighborhood. It may include pedestrian paths, landscaped planters, street furnishings and street trees.
- Pedestrian safety, comfort, and accessibility should be a primary consideration of street design and dimensioning.
- When alleys are present, vehicular access from alleys is preferred. Vehicular access from public streets shall be considered in the following order: Other Streets, Secondary Streets, Tertiary Streets and then Primary Streets as approved by Metro departments.



Section IV: General Standards

Street Character

Street Types

- **Primary Street:** Primary Streets accommodate high levels of pedestrian activity and high levels of vehicular traffic. On Primary Streets, active uses – residential, retail, restaurant or office – lining parking structures and on the first floor of buildings, and restricted vehicular access enhance the pedestrian experience. Primary streets provide the opportunity for more intense, urban development including shallow Build-to Zones and, in some cases, increased building height. Pedestrian comfort on these streets is of highest importance. Primary streets should have a continuous street wall, wide sidewalks between 15 and 20 feet to provide room for street furniture such as benches, trash receptacles, and bicycle parking. Primary Streets have the highest level of urban activity such as, outdoor dining, retail displays, and community activities like markets, parades, and music. Street trees provide protection from the sun and rain, reduce stormwater runoff and air pollution, and provide aesthetic value to the city. Trees should be planted in wells with tree grates to allow for the uninterrupted flow of pedestrian traffic.
- **Secondary Street:** Secondary Streets have moderate levels of pedestrian activity and moderate levels of vehicular traffic. Secondary Streets may be mixed-use or more residential in character. The Build-to Zone is generally shallow, and building heights are limited. In mixed-use areas, a continuous street wall should be maintained and sidewalks should be between 12 and 15 feet wide to accommodate pedestrian traffic. In residential areas, the required minimum façade width is limited – allowing for more space between buildings – and sidewalks may be narrower. Both tree wells and open landscaped planters are appropriate depending on sidewalk width.
- **Tertiary Street:** Tertiary Streets are the less important than Primary and Secondary streets. They may function as “back of house” for buildings with multiple street frontages. Care should be taken to make these streets as pedestrian-friendly as possible while accommodating loading and access needs.



Broadway is a Primary Street due to the high intensity of urban activity.



Third Avenue south of Broadway is a Secondary Street within a mixed-use area.



Ninth Avenue North is a Secondary Street within a residential area.

Section IV: General Standards

Street Character

- **Other Street:** Other Streets are streets that do not fall into any of the other street categories. They may have high or moderate levels of vehicular traffic, but often have no access to property and limited pedestrian activity. Building height along these streets is regulated by the other property frontages. Buildings do not front on these streets and may be built up to the property line.
- **Alley:** Alleys are service roads that provide shared access to property. Public utilities as well as access to mechanical equipment and trash should be located off an alley whenever possible. Where alleys exist and are in working condition, or where new alleys can be created through the dedication of new right-of-way, alleys are prioritized for access and loading.



Other Streets are less traveled by pedestrians and have limited access for vehicles from adjoining lots.

Sidewalk Corridor

- The Sidewalk Corridor is the portion of the right-of-way between the vehicular lanes and the property line or building façade.
 - The primary function of the Sidewalk Corridor is to provide a safe, comfortable, and convenient route for pedestrian travel that is separated from vehicular movements.
 - The Sidewalk Corridor is a public space that should include pedestrian amenities such as seating, shade trees, places to congregate, trash receptacles and outdoor dining.
 - The Sidewalk Corridor may accommodate public utilities such as electric poles and vaults, water and sewer lines, bus stops and traffic signals.
- As property develops within the DTC boundaries, property owners shall consult with Metro Planning and Public Works to make the necessary improvements to the streetscape in accordance with *the Major and Collector Street Plan, the Downtown Streetscape Elements Design Guidelines, the Strategic Plan for Sidewalks and Bikeways* and Title 17.20.120 Provision of sidewalks.



Alleys provide access for parking and service areas.

Section IV: General Standards

Street Character

Street Trees

Shade-producing street trees shall be planted in the public right-of-way along the length of the lot frontage at a maximum spacing of fifty feet or in accordance with the regulations of Metro departments and agencies.

Tree Quality

Tree species shall be chosen from the *Urban Forestry Recommended and Prohibited Tree and Shrub List* based on tree size and planting area provided or an alternative species deemed appropriate by the Urban Forester.

- At planting trees, shall meet the requirements for street trees set out in the *American Standard for Nursery Stock*.
- All nursery stock used as street trees shall be vigorous, healthy and free of diseases or infestation.
- Planting Area Dimension
 - The following standards are minimum standards. All development is encouraged to provide street trees with the largest area of pervious surface and volume of soil that can be accommodated.
 - Trees shall be accommodated in planting areas with a minimum depth of 3 feet and a minimum soil volume of 400 cubic feet.
 - The minimum pervious opening at grade shall be 25 square feet.
 - Tree vaults shall have the capability to drain water.
 - Planting areas shall not inhibit ingress/egress from buildings or pedestrian traffic along the Sidewalk Corridor.

Future Streets

Downtown thrives on a connected system of streets which allow easy access within neighborhoods and to other parts of the city. There are, however, places for improvement. The Future Streets Plan show how streets could be realigned, connected and created in the future to improve mobility within Downtown.

Properties near an area highlighted for change on the Future Streets Plan shall consult with the Planning Department and the Department of Public Works to discuss the potential change.

Section IV: General Standards

Future Streets Plan

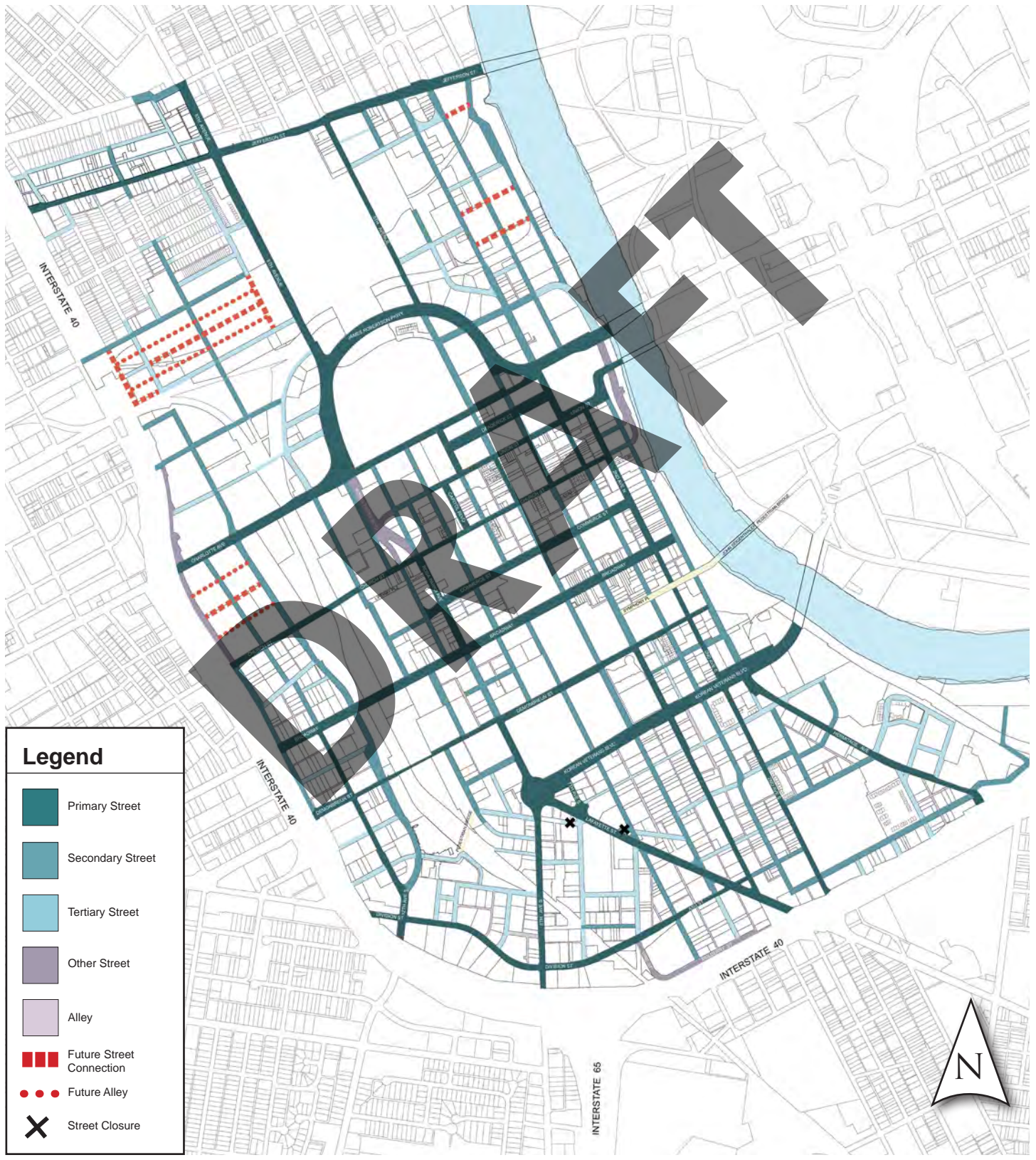

Section IV: General Standards

Lots and Frontages

Frontages

A Frontage is the specific way in which the building face addresses the street. It is the transition and interaction between the private and public realms. Building Frontages define the character and form of the public spaces within each neighborhood. The following standards shall apply to all development within the DTC.

- Buildings shall front a street (excluding alleys), open space, or a pedestrian passage.
- Principal and Minor Frontages
 - Every property shall establish one Principal Frontage along a street.
 - When a lot fronts more than one street the following priority shall be given when establishing the Principal Frontage: Primary Street, Secondary Street, Tertiary Street, Other Street.
 - Any other frontage(s) shall be treated as a Minor Frontage.
 - In the instance a property fronts multiple Primary streets, any may be chosen as the Principal Frontage or all may be treated as the Principal Frontages.
 - Along a Minor Frontage, the façade width may be reduced to the maximum depth of the building along the Principal Frontage. The remaining lot width shall be defined with a knee-wall according to the Walls and Fences section of the DTC.
 - Along a Minor Frontage, modifications may be granted for the reduction of ground level garage liners and/or glazing requirements.
- Façade Width
 - The minimum façade width is the minimum amount of the frontage that must be defined by a building and is designated as a percentage of the frontage.
 - If a single lot frontage is greater than two hundred feet, the façade width may be reduced to a minimum of one hundred and fifty feet in length.
- Open Space Frontages
 - When building facades front on open space the standards of the adjacent street type (excluding Tertiary) shall apply.
 - All buildings fronting open space shall have a minimum of one primary pedestrian entrance on the open space.

• Pedestrian Passage Frontages

- When building facades front on a pedestrian passage the standards of the adjacent street type (excluding Tertiary) shall apply.
- All buildings fronting a pedestrian passage shall have a minimum of one primary pedestrian entrance on the pedestrian passage.

Build-to Zone

- The Build-to Zone is the specified depth along a property's street frontage(s) in which the required minimum façade width must be located. The depth is Subdistrict and Street Type specific.
- Depending on site conditions the front of the Build-to Zone may begin at different locations.
 - When the existing sidewalk meets the Major and Collector Street Plan standards for sidewalk width, the Build-to Zone begins at the back of the sidewalk/property line.
 - When the existing sidewalk does not meet the Major and Collector Street Plan standards for sidewalk width, the sidewalk shall be widened on site and the Build-to Zone begins at the back of the new sidewalk.
 - When utility or pedestrian easements exist along the street frontage of a property the Build-to Zone shall begin at the back of the easement.
 - When buildings front an Open Space the Build-to Zone shall begin at the back of the Open Space.
- Attachments
 - Structures, including porches, stoops, and balconies shall not encroach beyond the front of the Build-to Zone.
 - Elements such as stairs, awnings, and landscaping may encroach beyond the front of the Build-to Zone. Any encroachments into the right-of-way must follow the Mandatory Referral process.
- Entrances
 - All buildings shall have at least one pedestrian entrance on the Principal Building Frontage. This may be access to a lobby shared by individual tenants.
 - Corner entrances are appropriate on corner lots.

Section IV: General Standards

Lots and Frontages

- Glazing

- All street level exterior windows must be clear and fully transparent.
- Modifications may be permitted insofar as it is determined that tinting does not substantially diminish the effect of the building wall or the pedestrian character of the street.

- Vehicular Access

- When calculating the minimum façade width, access to structured parking shall be counted as part of the required façade width, and access to surface parking shall not be counted part of the required façade width. That is, access to surface parking is allowed in the “remaining” area, after the façade width requirement has been met. Surface parking is not allowed in the “remaining” area.

Active Use

- An active ground floor use requirement shall mean a habitable space occupied by retail, office, residential, institutional or recreational uses, specifically excluding parking, and mechanical uses. Active uses are those programmed spaces that generate pedestrian street activity and interaction. Hallways, storage rooms, fitness centers, and other ancillary spaces shall not qualify as an active use.
- An active use is required on the ground floor of all Primary streets, Secondary streets, Open Space and pedestrian passages. An active use is encouraged on Tertiary streets, particularly if the Tertiary street is the only street frontage, but is not required.
- Any references to the requirement of an active use on the ground floor on “streets” or “public streets” shall exclude Tertiary streets, Other streets, and alleys and shall include Open Space and pedestrian passages. However, if a Tertiary street is a project’s only street frontage, all active use requirements shall apply on that frontage.
- The term “active use” and “building liner” are synonymous.

Materials

- EIFS, stucco, plywood, plastics, and concrete block are prohibited as façade materials on any façade visible from a public street, open space, or interstate in all subdistricts.
 - Modifications may be permitted insofar as it is determined that these materials are necessary to further an established, overriding policy goal and will not significantly diminish the pedestrian experience.

Auto-oriented canopies and awnings

- Auto-oriented canopies and awnings, for uses such as drive-thrus and gas station pumps, may be attached to a building according to the following:
 - The building shall comply with all Frontage standards.
 - The canopy and/or awning shall be lower in height than the primary building.
 - The setback of the canopy and/or awning shall be a minimum of 15 feet from the back of the Build-to Zone.
- Exteriors
 - Any new roof or complete resurfacing of an existing roof must use a roofing material having an SRI of 29 or greater for roof slopes greater than 2:12 or SRI of 78 for slopes less than or equal to 2:12.

This page left intentionally blank

DRAFT

Section IV: General Standards

Lots and Frontages: Specific to Storefront Frontage

The Storefront Frontage has a limited Build-to Zone that is close to the street, with building entrances accessible at sidewalk grade. The Storefront Frontage has substantial glazing on the facade at ground level, space for pedestrian-oriented signage, awnings, retail display, and other design features conducive with creating an active commercial streetscape.

The Storefront Frontage is commonly used for general commercial, office, retail, restaurant, lobby, etc.



DRY

Section IV: General Standards

Lots and Frontages: Specific to Storefront Frontage

Storefront Frontage

A Max. sill height	3 ft
B Min. ground floor height	14 ft from grade
C Min. upper floor(s) height	10 ft floor to floor
D Min. ground floor glazing Principal Frontage Minor Frontage	60% from grade to 14 ft 40 % from grade to 14 ft
E Min. upper floor(s) openings	25% from floor to floor

Notes

Where Storefront frontage is allowed, modifications may be given to allow for a Storefront arcade. All Storefront Frontage standards shall be met on the facade behind the arcade.

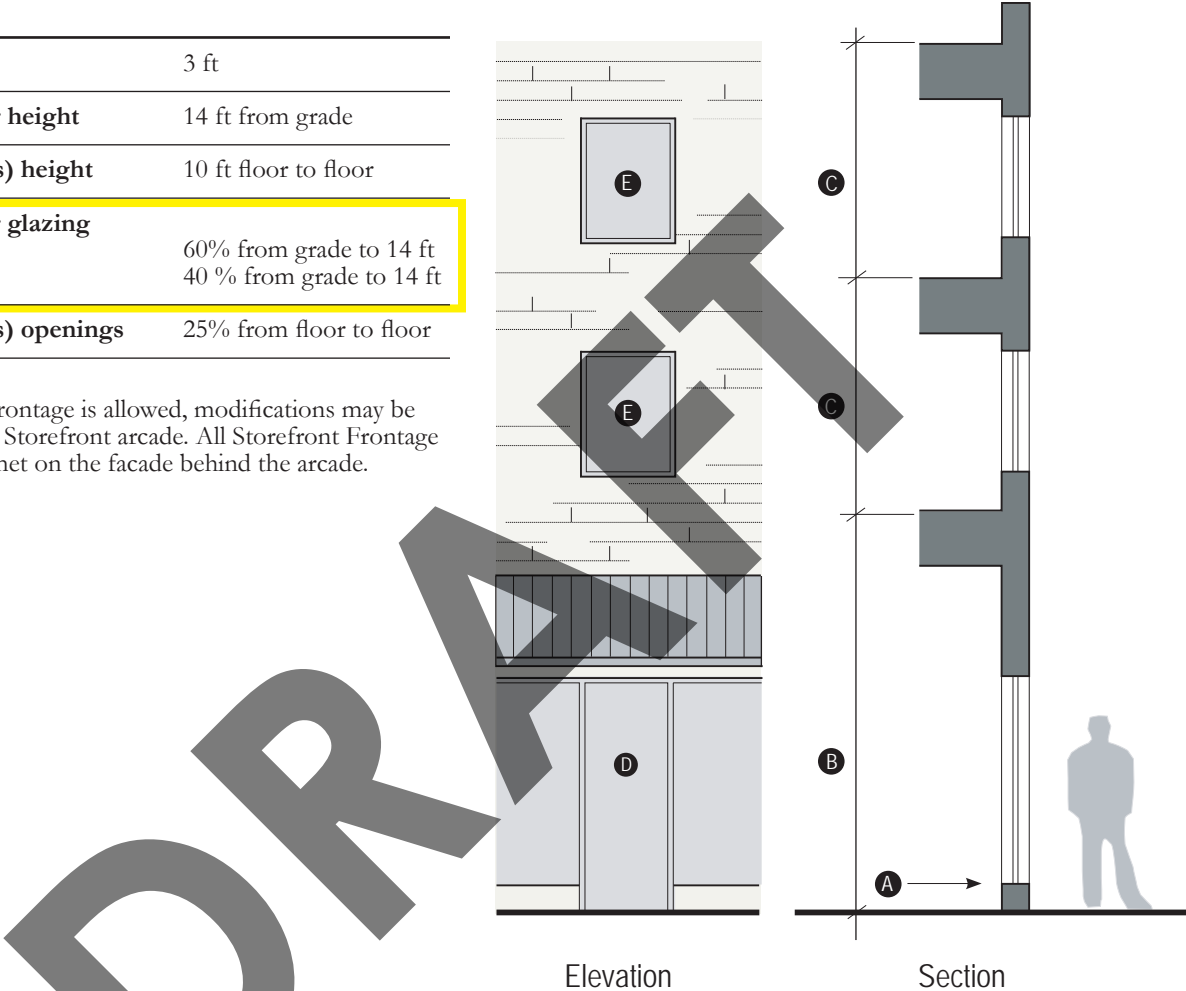

Section IV: General Standards

Lots and Frontages: Specific to Stoop Frontage

The Stoop Frontage has a limited to moderate Build-to Zone with the first floor elevated from the sidewalk grade. This frontage type utilizes a stoop - a small landing connecting a building entrance to the sidewalk by a stair or ramp - to transition from the public sidewalk or open space into the building.

Stoops are generally provided externally, but may be provided internally as necessitated for ADA compliance.

The Stoop Frontage is generally used for residential and live-work buildings, but may be appropriate for other uses.



DRAFT

Section IV: General Standards

Lots and Frontages: Specific to Stoop Frontage

Stoop Frontage

A First floor elevation	
Min.	18" from grade
Max.	5 ft from grade
B Min. ground floor openings	30% floor to floor
C Min. upper floor(s) openings	25% from floor to floor

Stoop

- D** Min. stoop width 5 ft
- E** Stoops may not extend beyond the front of the Build-to Zone.
- F** Steps may extend beyond Build-to Zone, but may not encroach into the public Right-of-Way.

Notes

Greater first floor elevation allowed by modification for:

- Property with significant elevation change across the site at the street frontage.
- Development that incorporates below grade basement floors that are accessible from the exterior of the building.

Transition to first floor elevation may be accommodated on the interior of the building to allow for compliance with ADA accessibility requirements.

Entries shall not be recessed more than 4 feet from the facade of the building.

Doors shall face the street.

DRAFT

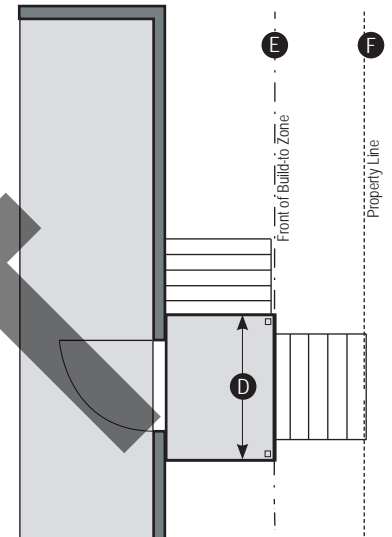

Plan

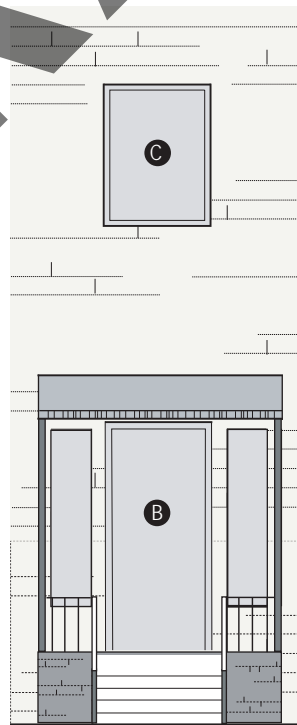

Elevation

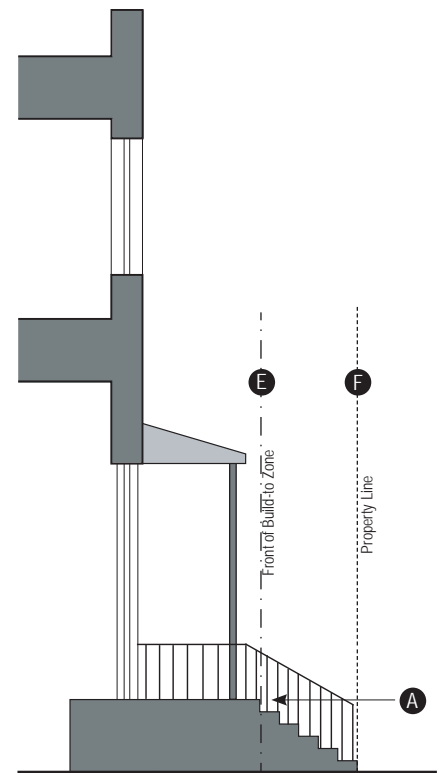

Section

Section IV: General Standards

Lots and Frontages: Specific to Porch Frontage

The Porch Frontage has a moderate Build-to Zone with the first floor elevated from the sidewalk grade. The Porch Frontage utilizes a porch - an open air room appended to the mass of a building with floor and roof but no walls on at least two sides - to transition from the public sidewalk or open space into the building.

The Porch Frontage is primarily used for residential buildings.



Section IV: General Standards

Lots and Frontages: Specific to Porch Frontage

Porch Frontage

A First floor elevation	
Min.	18" from grade
Max.	5 ft from grade
B Min. ground floor openings	30% floor to floor
C Min. upper floor(s) openings	25% from floor to floor
Porch	
D Min. porch depth	5 ft
E Stoops may not extend beyond the front of the Build-to Zone.	
F Steps may extend beyond Build-to Zone, but may not encroach into the public Right-of-Way.	

Notes

Greater first floor elevation allowed by modification for:

- Property with significant elevation change across the site at the street frontage.
- Development that incorporates below grade basement floors that are accessible from the exterior of the building.

Transition to first floor elevation may be accommodated on the interior of the building to allow for compliance with ADA accessibility requirements.

Entries shall not be recessed more than 4 feet from the facade of the building.

Doors shall face the street.

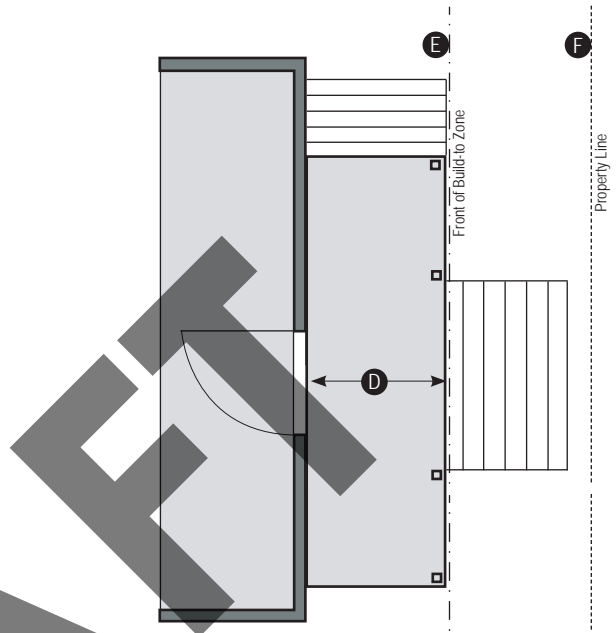

Plan

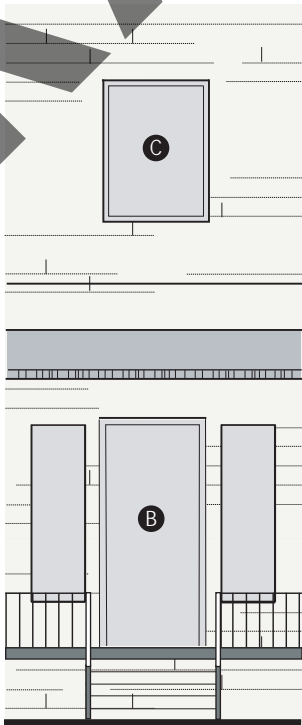

Elevation

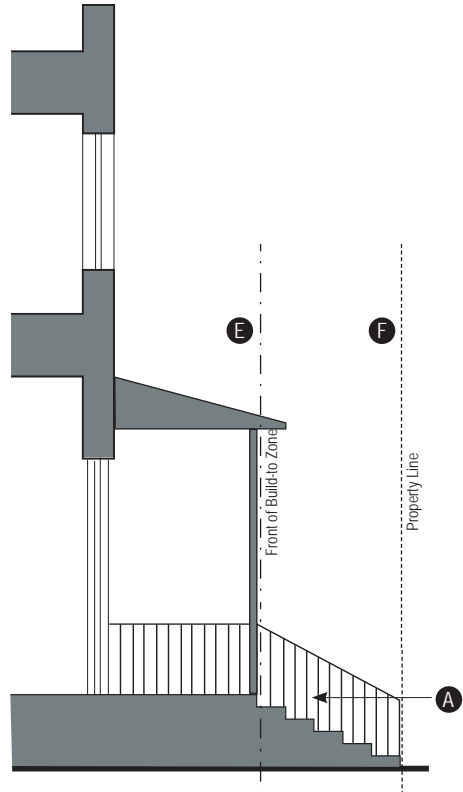

Section

Section IV: General Standards

Lots and Frontages: Specific to Industrial Frontage

The Industrial Frontage shall be used to adapt existing buildings to the standards of the DTC and for new construction of buildings intended for industrial uses. The Industrial Frontage shall be allowed only in specified subdistricts on specified streets and shall be prohibited on Primary Streets.

The Industrial Frontage mitigates the negative impact of the “blank wall” on the street by requiring the Build-to Zone to be entirely landscaped with drought-resistant plantings. All landscaping shall be in a functioning bioswale, or irrigated using drip irrigation or sub-surface irrigation. If drought-tolerant species are used, no irrigation is required.

A primary pedestrian entrance is required on the Principle Facade.

Associated vehicular entrances shall comply with the Parking and Access and Mechanical, Screening and Loading standards.

DRAFT

Section IV: General Standards

Lots and Frontages: Specific to Industrial Frontage

Industrial Frontage

A Front door	Required on Principle Facade
B Min. Building Height	25 ft from grade
C Build-to Zone	5-10 ft
D Landscaping	Entire Build-to Zone shall be landscaped with drought resistant species; in a bioswale or irrigated 2'-6"
E Min. landscaping height	

Notes

Industrial Frontage is prohibited on Primary streets. A building intended for an industrial use, with frontage on a Primary street shall comply with the standards of another frontage type on the Primary street.

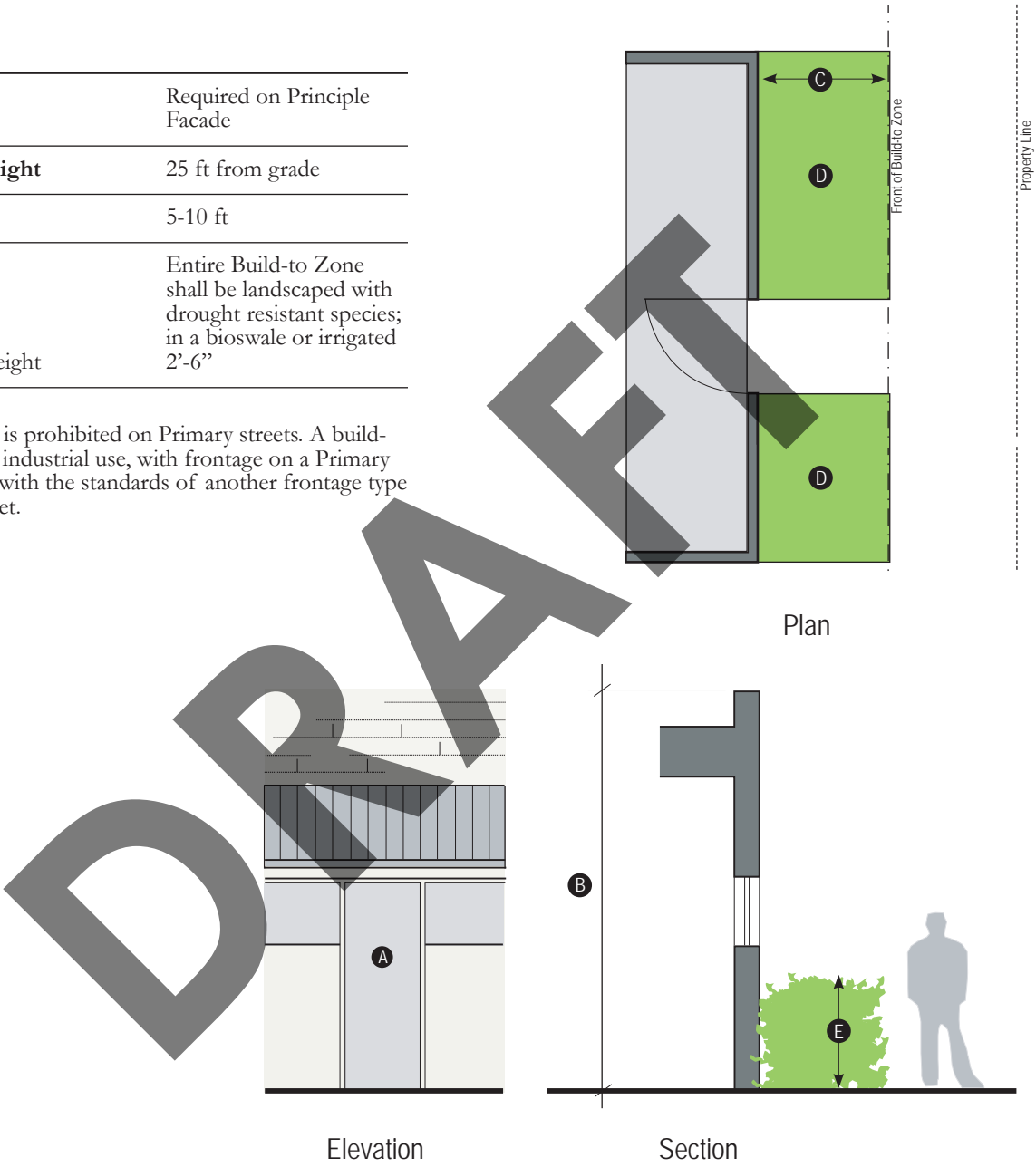

Section IV: General Standards

Lots and Frontages: Specific to Civic Frontage

Civic buildings are designed and constructed for community use or benefit by governmental, cultural, educational, public welfare, or religious organizations. Civic buildings are inherently unique structures that present opportunities for unusual and iconic design within the urban fabric. Civic buildings should be designed with prominence and monumentality.

A Civic building shall be oriented to streets and public spaces and follow the intent of the particular subdistrict in which it is located with regard to pedestrian orientation, massing, and articulation.

Key architectural features should act as community focal points. Where possible, street axes should be terminated by the primary building form or architectural feature. Towers, spires, and other vertical forms are encouraged.

Civic buildings may include the following: community buildings, libraries, post offices, schools, religious institutions, publicly owned recreational facilities, museums, performing arts buildings, and municipal buildings.

Civic buildings shall be reviewed by minor modification.



Section IV: General Standards

Canopies and Awnings

Canopies

A Clearance	
Minimum from sidewalk	8'
Minimum with ROW encroachment	14'
Maximum	25'
B Maximum projection	within 2' of curb
C Maximum canopy height	4'

Notes
 Canopies shall be permitted only over pedestrian and vehicular building entrances, and shall not be permitted above windows. Canopies shall be constructed as a roof-like structure. Fabrics and non-rigid plastic are prohibited.

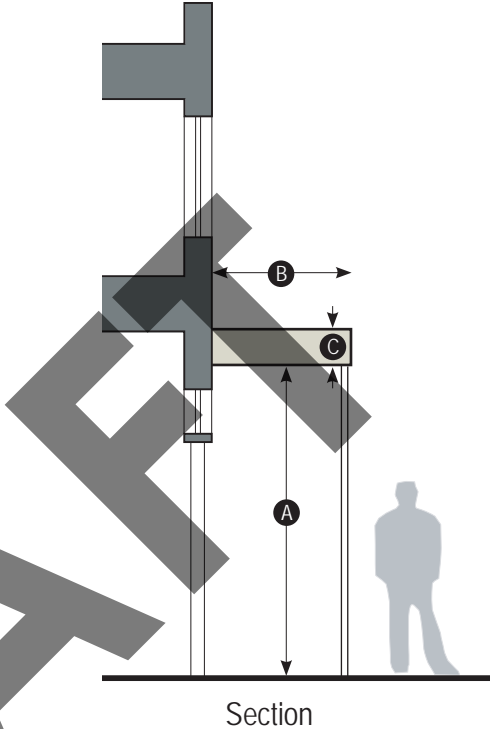

Awnings

A Clearance	
Minimum from sidewalk	8'
Minimum with ROW encroachment	14'
B Maximum projection	
First floor	4' from facade
Upper floors	2' from facade
C Maximum awning height	5'

See the Lots and Frontages section for details on auto-oriented canopies and awnings.

Encroachments in the public right-of-way must meet Metropolitan Government's current clearance standards and be approved under the mandatory referral process prior to installation.

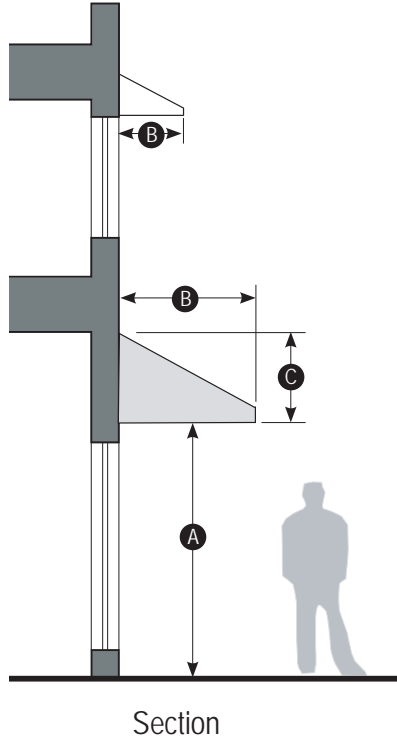

Section IV: General Standards

Parking and Access: General

Parking Requirements

- No parking is required within the boundary of the DTC.

Parking and Access General Standards

- In addition to the Parking and Access standards of the DTC the following shall apply:
 - 17.20.050 Handicapped parking, 17.20.060 Parking area design standards, and 17.20.130 Loading space requirements.
- When alleys are present, vehicular access from alleys is preferred. Access from public streets shall be considered in the following order: Other Streets, Secondary Streets, Neighborhood Streets and then Primary Streets as approved by Metro departments. Reviewers shall consider the public safety, street character, and pedestrian experience.
- Vehicular / Pedestrian Conflict
 - Where driveways to parking facilities or drop-off areas cross the Sidewalk Corridor, priority shall be given to the pedestrian realm and the following design elements shall be required:
 - The DTC and MCSP sidewalks and tree planting standards shall be maintained for any pedestrian islands created.
 - Bollards or other protective device shall be used to separate pedestrian and vehicular areas.
 - Distinction between vehicular lane and pedestrian areas shall be indicated through changes in grade, color, texture and/or material.
- To reduce stormwater fees and impact, utilize Low Impact Development strategies published in Metro Water Services Stormwater BMPs for hardscaping, including parking and drive lanes.

Section IV: General Standards

Parking and Access: Specific to Structured Parking

Vehicular Access

- Vehicular openings to parking structures shall not exceed thirty-five feet in width.
- Vehicular openings shall have a minimum spacing of thirty-five feet.

Pedestrian Access

- All parking structures with parking available to the public shall have a clearly marked pedestrian entrance, separate from vehicular access, on street frontages. A publicly accessible building lobby may meet this requirement.

Location and Lining

- On the ground level, parking structures shall be located behind a liner building with an active use that is a minimum of fifteen feet deep.
- Upper level habitable liners are encouraged on all streets and are required on James Robertson Parkway. See the Bonus Height Program for more information on incentives for upper level garage liners.
- Upper level facade treatments /cladding is required on all public street frontages, including any facades visible from the Interstates. Facade treatments shall integrate or complement the architectural characteristics of the habitable portion of the building and the surrounding built context. Openings for natural ventilation are permissible when integrated into the facade design. Landscape buffering may be considered as an alternative at appropriate locations, such as Interstate frontages.

- All underground parking shall not be visible from the surface of the earth. Underground parking that is completely below grade may extend beyond the façade of the building. Underground parking may not encroach into the right-of-way.

Quantity

- The number of stories of unlined structured parking shall not exceed the number of stories of underground parking



Appropriate upper level facade treatment with full cladding



Appropriate upper level facade treatment with natural ventilation integrated into the facade design



Inappropriate upper level facade treatment

Section IV: General Standards

Parking and Access: Specific to Surface Parking

General Standards for Surface Parking

- Parking area screening and landscaping standards shall apply to all surface parking lots including, but not limited to, public and private parking facilities, driveways and access aisles, the outdoor display of automobiles and other vehicles that are for sale or lease.

Perimeter Screening Standards for Surface Parking

- Parking areas adjacent to public streets and open space shall be separated from the edge of the right-of-way and/or property line by a perimeter landscape strip a minimum of five feet in width which shall be landscaped per the standards of this section.
 - All perimeter landscape strips adjacent to public streets and open space shall include a fence or wall in accordance with the Fence and Wall Standards.
- Parking areas shall be separated from adjacent side lot lines by a perimeter landscape strip a minimum of 5 feet in width, which shall be landscaped per the standards of this section.
 - A two and one-half foot landscape strip may be provided if the required trees are to be planted in tree islands located adjacent to the property line.
 - Two adjacent properties may share equally in the establishment of a seven-foot (minimum) planting strip along the common property line. In instances where the common perimeter planting strip is part of a plan for shared access, each owner may count the respective area contributed toward that common planting strip toward the interior planting area requirements for the lot.
- Berms are not permitted in any landscape strips.

Interior Planting Requirements

- Parking areas shall be landscaped in accordance with the interior planting requirements of Title 17.24.160.
- Parking areas with less than twelve thousand square feet in total area shall be exempt from the interior and side lot line planting requirements.

Landscape Materials

- Perimeter landscape strips along public streets, open space and side lot lines.
 - Trees shall be installed at a rate of one tree for every thirty feet of frontage. Spacing may be adjusted with the approval of the Urban Forester based upon tree species, the presence of utilities, and the dimensions of the planting strip.
 - Evergreen shrubs and trees shall be installed at appropriate spacing to fully screen vehicles to a minimum height of two and one-half feet.
 - Plantings within fifteen feet of driveways or street intersections shall be maintained to a maximum height of two and one-half feet.
 - Plantings shall not obstruct views onto site as to impede the security of users.
- Tree and shrub species shall be chosen from the Urban Forestry Recommended and Prohibited Tree and Shrub List or an alternative species deemed appropriate by the Urban Forester.
- At planting, trees shall be a minimum of six feet in height and two caliper inches.
- All landscaping shall be in a functioning bioswale, or irrigated using drip irrigation or sub-surface irrigation. If drought-tolerant species are used, no irrigation is required.
- At planting, all landscaping shall meet the standards for size, form and quality set out in the American Standard for Nursery Stock (ANSI Z60.1, latest edition).
- All nursery stock shall be vigorous, healthy and free of diseases or infestation.

Section IV: General Standards

Mechanical, Service, and Loading

Applicability

The following elements shall be shielded from view from adjacent public streets, pedestrian corridors, and open spaces.

- Refuse collection, dumpsters, recycling bins, and refuse handling areas that accommodate a dumpster or five or more trash or recycling cans.
- Building or ground-mounted mechanical equipment, including, but not limited, to transformers, backflow preventors, telephone risers, equipment cabinets, generators, or similar devices.
- Mechanical equipment on roofs.
- Air conditioning or similar HVAC equipment.
- Loading docks, berths, or similar spaces including, but not limited, to service entrances and maintenance areas.
- Outdoor storage of materials, equipment, and vehicles.

Location and Access

- Applicable site elements shall be located along the alley, along an interior property line, or internal to the property.
- Service elements, such as loading docks and trash collection locations, should not be accessible from Primary streets, unless a Primary street is the only frontage.
- Where access to loading areas and service elements cross the Sidewalk Corridor, priority shall be given to the pedestrian realm and the following design elements shall be required:
 - The DTC and MCSP sidewalks and tree planting standards shall be maintained for any pedestrian islands created.
 - Bollards or other protective device shall be used to separate pedestrian and vehicular areas.
 - Distinction between vehicular lane and pedestrian areas shall be indicated through changes in grade, color, texture and/or material.

Screening Standards

- Applicable site elements shall be fully screened at all times, including immediately following planting if vegetative materials are to be used.
- Refuse collection and refuse handling areas shall be screened by a walled enclosure with gates in accordance with the Fence and Wall Standards of the DTC.

Screening Methods

- Vegetative Materials:
 - Vegetative materials shall be planted in two rows in staggered fashion.
 - All trees shall be evergreen with a minimum height at time of planting of at least six feet above the root ball.
 - All shrubs shall be evergreen with the minimum height and spacing necessary to fully screen the item intended for screening (but no less than thirty inches in height) at the time of planting.
 - Vegetative material shall be located immediately adjacent to the element being screened in a planting area a minimum of four feet wide.
- Fencing and Walls
 - Screening is permitted through the use of a fence or wall constructed in accordance with the Fences and Walls Standards of the DTC.
- Parapet Walls
 - Parapet walls or other techniques included as an integral part of the building design shall be used to totally screen any rooftop mechanical equipment from view from adjacent public rights-of-way or open space.
- Integrated Building Elements or Features
 - Building design or other structural features (e.g., knee walls, alcoves, wing walls, roof extensions, etc.) may also be used to fully or partially enclose site features required to be screened.
- Alternative Screening Methods
 - Alternative screening methods or materials that are not listed may be used following approval by the Planning Commission or its designee, provided that they are determined to be comparable to screening methods described in this subsection.

** In order to properly locate and screen mechanical equipment, approval may be required from applicable Metro departments and agencies.

Section IV: General Standards

Fences and Walls

Location

- Permitted Locations: Fences and walls constructed in accordance with the standards in this section may be constructed within:
 - The Build-to Zone.
 - A utility easement only through the express written consent from the utility or entity holding the easement.
 - A required landscape area, Tree Protection Zone, or open space.
- Prohibited Locations: No fence or wall shall be installed that:
 - Encroaches into a right-of-way (without approval through the Mandatory Referral process).
 - Blocks or diverts a natural drainage flow on to or off of any other land.
 - Compromises safety by blocking vision at street intersections or obstructs the visibility of vehicles entering or leaving driveways or alleys.
 - Blocks access to any above ground or pad-mounted electrical transformer, equipment vault, fire hydrant or similar device.

Appearance

- All fences shall be installed so that the finished side shall face outward; all bracing shall be on the inside of the fence.
- Fences and walls shall be constructed of any combination of brick, stone, masonry materials, treated wood posts and planks, rot-resistant wood, or metal. Chain link fencing shall be coated with dark green or black vinyl when visible from a public street or open space (excluding alleys).
- Chain-link fences are prohibited within the Build-to Zone.
- Razor wire is prohibited within the Build-to Zone.
- Fences and walls used to screen refuse areas shall be opaque and include gates that prohibit unauthorized users to access the area.

Standards by function and location

- Fences and walls within the Build-to Zone shall not exceed four feet in height.
 - Modifications may be made in order to properly secure playgrounds and parks.
 - The height of fences and walls along a sidewalk shall be measure from sidewalk grade.
- Fences and walls within the Build-to Zone that are greater than three feet high shall be a minimum of thirty percent transparent to allow visibility into the property.
- Fences and walls used to screen parking shall be a minimum of two and one-half feet above the grade of the parking lot.
 - When a fence or wall is combined with plantings the majority of the plantings shall be between the right-of-way and the fence or wall.
- Fences and walls used to screen mechanical, loading and refuse elements shall be a minimum of two feet taller than the element being screened.
- All other fences and walls shall have a maximum height of ten feet measured from grade.
- Fences surrounding athletic fields and courts may exceed the previous height limitations.

Section IV: General Standards

Open Space

The *Downtown Community Plan: 2007 Update* envisions accessible, enjoyable open spaces to help create vital and functioning neighborhoods within Downtown. To meet this goal, the DTC encourages many types of open spaces to serve the needs of both citizens and visitors for passive and active recreation. Public art, other amenities, and interactive features are encouraged in open spaces. Buildings conducive with the use of the Open Space and for public use may be approved by the Planning Commission and Parks Department.

It is a goal of the DTC to have open space within each ¼ mile radius neighborhood in Downtown. All public and private open spaces, greater than one-half acre have been mapped in order to determine the areas within the DTC that are in need of neighborhood open space. The one-quarter mile radius buffer area around existing open spaces is indicated in green on the Open Space Map. The areas that lack open space within one-quarter mile radius (deficiency areas) are shown in yellow. Public open space developed in any portion of a deficiency area will count toward fulfilling the open space need of that area. The development of the needed open space may be done by public or private entities.

The open space types and standards listed in the DTC shall be utilized by property owners in the development of public open space. The following standards shall apply to open space that is accessible to the public, including open space developed for credit under the Bonus Height Program. Private open space or amenity areas shall not be counted toward fulfilling the open space need and shall not be eligible for the Bonus Height Program.

Open Space developed within the deficiency areas are eligible for greater bonuses through the Bonus Height Program than those developed in non-deficiency areas. See the Bonus Height Program section for more details.

The Open Space Plan also includes the existing and planned urban greenways.

Parks and greenways are publicly owned open space and shall follow the standards set out by the Parks Department.

Section IV: General Standards

Open Space Plan

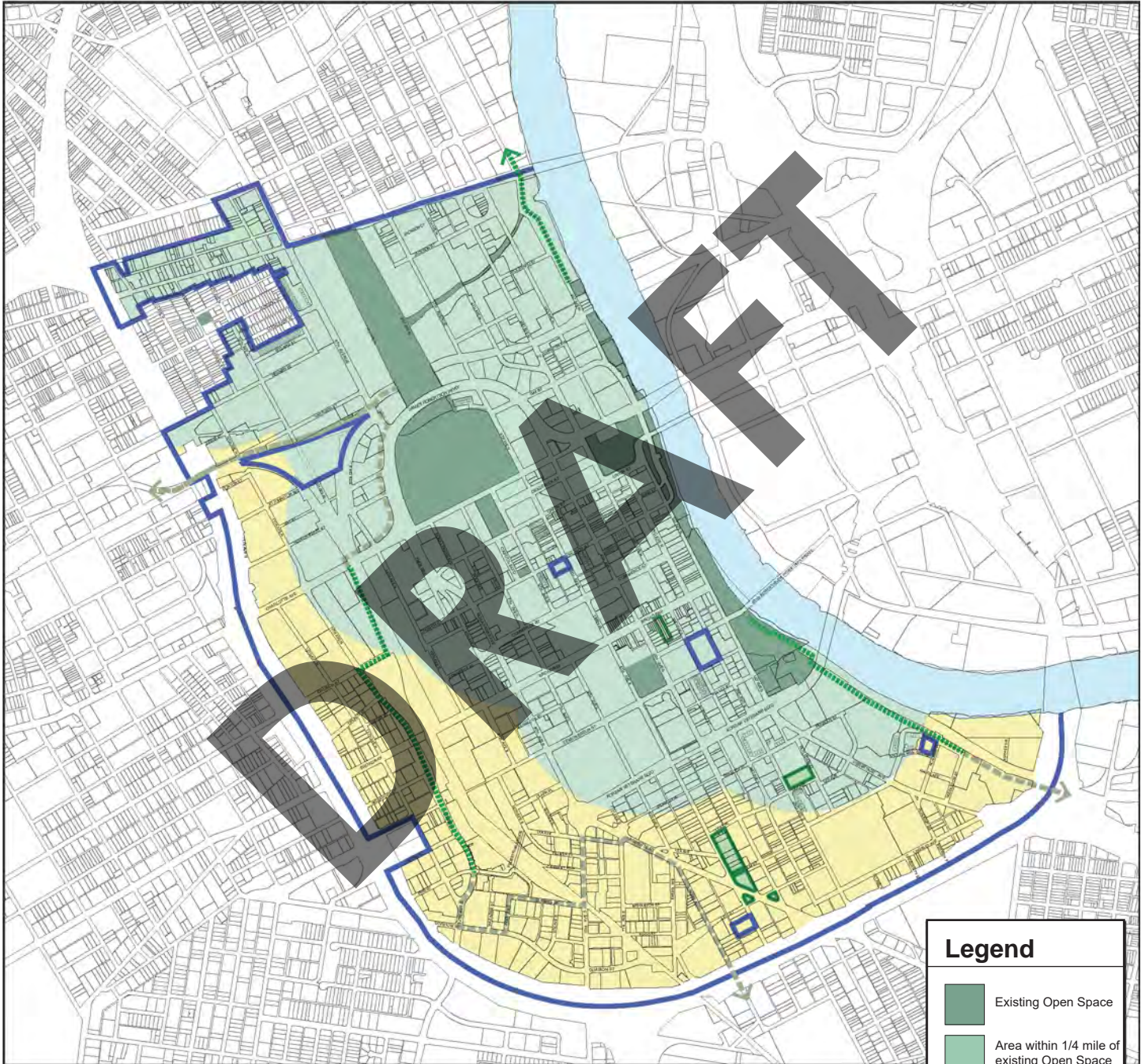

Legend

- Existing Open Space
- Area within 1/4 mile of existing Open Space
- Area with an Open Space Deficiency
- Existing Urban Greenway
- Future Urban Greenway
- Potential parcels for Open Space
- DTC Boundary



Section IV: General Standards

Open Space: General Standards

Standards of Title 17 not varied by the following Open Space Standards shall apply within the DTC.

Calculation

- When calculating the open space square footage or acreage, the footprint of any building, whether public or private, shall be subtracted first. The remaining square footage shall be used for all calculations and percentages.

Access

- Every open space shall have a minimum of one primary pedestrian entrance along each street frontage and pedestrian frontage.
- All publicly accessible open space shall meet the appropriate standards of the American's with Disabilities Act.

Building frontage

- Buildings that are part of the same development as the open space and abut the open space shall have a minimum of one pedestrian entrance on the open space.

Seating

- Permitted types of seating include but are not limited to, moveable, fixed individual seats, fixed benches, seat walls, planter ledges and seating steps.

Paving Materials

- Asphalt may be approved by the Planning Commission or its designee for recreational jogging or bicycle paths only.

Landscaping

- Ground level green space shall consist of turf grass, shrubbery, perennial and annual beds, mulched areas and generally areas with "natural" material planted within six inches of grade.
 - Ground level green space does not include container plantings.
- Pervious surfaces include green space, porous concrete and modular pavers, areas with tree grates or areas that otherwise allow water to infiltrate into the soil.
- Trees shall be accommodated in planting areas with a minimum of 600 cubic feet of soil. When using structural soil, the planting area may be reduced to 300 cubic feet. The minimum opening at grade shall be 25 square feet.
- Planting areas shall not impede ingress/egress from buildings or pedestrian traffic.
- Tree Grates
 - When used, tree grates shall be modular and allow for removal as tree grows.
 - Tree grates shall be flush with grade to allow for unobstructed movement of pedestrian traffic.
- Tree and shrub species shall be chosen from the Urban Forestry Recommended and Prohibited Tree and Shrub List based on tree size and planting area provided or an alternative species deemed appropriate by the Urban Forester.

Section IV: General Standards

Open Space: Specific to Greens

Greens are larger, less formal Open Space consisting of a majority green space with laws, paths, and vegetation.

- A minimum of two sides shall be street frontages.
- Size ½ acres - 6 acres
- Greens shall maintain a minimum of 60 percent ground level green space and 70 percent pervious surface.
- Seating
 - A minimum of one linear foot of seating shall be required for each 900 square feet of gross open space.
 - Of the required seating, one linear foot for each 20 feet of street frontage shall be located within 15 feet of the property line.



Section IV: General Standards

Open Space: Specific to Squares

Squares are Open Space used for unstructured recreational or civic uses. Landscaping consisting of lawns and trees is formally composed.

- A minimum of two sides shall be street frontages.
- Size: ½ acre – 5 acres
- Squares shall be required to maintain a minimum of 30 percent ground level green space and 50 percent pervious surface.
- Seating
 - A minimum of one linear foot of seating shall be required for each 700 square feet of gross open space.
 - Of the required seating, one linear foot for each 20 feet of street frontage shall be located within 15 feet of the property line.

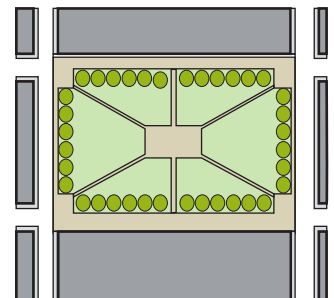

Section IV: General Standards

Open Space: Specific to Plazas

A Plaza is an Open Space used for unstructured civic and/or commercial purposes. A plaza is spatially defined by building frontages.

- Size: 2500 square feet – 20,000 square feet
- Plazas are required to maintain a minimum of 10 percent ground level green space and 40 percent pervious surface.
- Seating
 - A minimum of 40 linear feet of seating shall be required for Plazas, plus a minimum of one linear foot of seating for every 500 square feet of gross open space.
 - Of the required seating one linear foot for each 20 feet of street frontage shall be located within 15 feet of the property line.



DRAFT

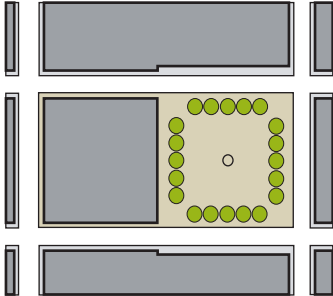

Section IV: General Standards

Open Space: Specific to Courts

A Court is Open Space accessible from the street and used for entry into a building. A Court is spatially defined by building frontages and is generally tucked back into the building.

- Size: 400 square feet – 2,500 square feet
- Seating
 - A minimum of 10 linear feet of seating shall be required for Courts, plus one linear foot of seating for each 300 square feet of open space minimum.
- Accessibility
 - Courts are permitted to be closed to the public by use of a gate. See the Fence and Wall Standards for details.



DRAFT

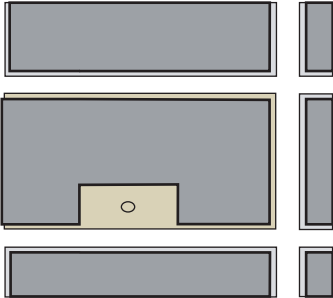

Section IV: General Standards

Open Space: Specific to Pocket Parks and Playgrounds

Pocket Parks and Playgrounds are Open Space that are accessible from the street and used for structured recreation, gardening or other community use.

- Size: 800 square feet – 1 acre
- Pocket Parks shall provide a community benefit such as a garden or playground.
- Pocket Parks are required to maintain a minimum of 20 percent ground level green space.
 - Additional ground area may be impervious provided space is structured for active recreation.
- Seating:
 - A minimum of one linear foot of seating shall be required for every 300 square feet of gross open space.
- Trees
 - The tree requirement may be waived for pocket parks that are designed for structured active recreation, such as basketball or tennis courts.
- Accessibility
 - Pocket Parks may be fenced for safety but shall remain open to the public during daylight hours.



DRAFT

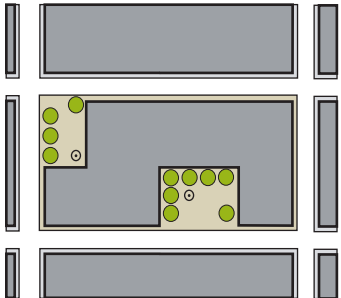

Section IV: General Standards

Bonus Height Program

The Bonus Height Program (BHP) allows additional building height in Downtown in exchange for contribution to specified programs that provide benefits to the public. The Bonus Height shall be permitted if the proposed development contributes to specific public benefits in the amount and manner set forth herein.

Bonus Height shall be permitted in exchange for the following public benefit contributions: Leadership in Energy and Environmental Design (LEED) certification of individual buildings, LEED for Neighborhood Development, pervious surface, Historic Building Preservation, publicly-accessible Open Space, Inclusionary Housing, Civil Support Space, upper level garage liners, and underground parking.

Bonus Height Standards

- Upon providing a binding commitment for the specified public benefit, the proposed development project shall be allowed to build within the restrictions of the Subdistrict, up to the Bonus Height Maximum as established within this section.
- Multiple height bonuses may be compounded insofar as the total additional height does not exceed the Bonus Height Maximum for the Subdistrict.
- Additional development rights achieved through the BHP may be transferred one time to a receiving site within the DTC, provided the transferred height does not exceed the Bonus Height Maximum of the receiving site. For the purposes of the Bonus Height Program, 'receiving site' means a single parcel or group of adjacent parcels with common ownership, or up to two adjacent parcels without common ownership. By-right height may not be transferred; only bonus height received through the BHP may be transferred.
- Bonus height transfers shall be based on the square footage of the sending site, not the receiving site.
- No building permit shall be issued for bonus height until the Planning Commission has certified compliance with the provisions of this section, upon referral and assurance of compliance from applicable departments.

Section IV: General Standards

Bonus Height Program

LEED and LEED ND

The U.S. Green Building Council (USGBC) is a non-profit organization that oversees the Leadership in Energy and Environmental Design (LEED) Green Building Rating System.

LEED for Neighborhood Development integrates the principles of smart growth, urbanism and green building into the first national system for neighborhood design. LEED ND goes beyond the building to address sustainability on a neighborhood-wide basis.

The bonuses are specific to each Subdistrict. See the BHP Chart for details.

A different nationally-recognized, third-party system of overseeing green building and/or sustainable development practices may be substituted for LEED. Bonuses will be determined by the Planning Commission based on ratings equivalent to LEED silver, gold, and platinum.

Bonuses for individual buildings are given upon pre-certification of LEED silver, gold and platinum. Bonuses for neighborhoods are given upon pre-certification of LEED ND. Every property within the LEED ND neighborhood may utilize the bonus height. The bonuses are specific to each Subdistrict. See the BHP Chart for details.

The following shall apply to all new construction that utilizes the Bonus Height Program for LEED:

- Prior to issuance of a temporary certificate of occupancy for any use of the development, a report shall be provided for the review of the Department of Codes Administration and the Planning Commission by a LEED accredited professional. The report shall certify that all construction practices and building materials used in the construction are in compliance with the LEED certified plans and shall report on the likelihood of certification. If certification appears likely, temporary certificates of occupancy (as set forth below) may be issued. Monthly reports shall be provided as to the status of certification and the steps being taken to achieve certification. Once certification is achieved, the initial certificate of LEED compliance, as set forth herein, and a final certificate of occupancy (assuming all other applicable conditions are satisfied) shall be issued.
- To ensure that LEED certification is attained the Department of Codes Administration is authorized to issue a temporary certificate of occupancy once the building is otherwise completed for occupancy and prior to attainment of LEED certification. A temporary certificate of occupancy shall be for a period not to exceed three (3) months (with a maximum of two extensions) to allow necessary time to achieve final certification. Fees for the temporary certificate (and a maximum of two extensions) shall be \$100 or as may otherwise be set by the Metro Council. Once two extensions of the temporary certificate of occupancy are granted, any additional extensions shall be granted only in conjunction with a valid certificate of LEED noncompliance as set forth herein.
- If the property fails to achieve LEED certification, the Department of Codes Administration is authorized to issue a short-term certificate of LEED noncompliance. This certificate will allow the building to retain its certificate of occupancy pending attainment of LEED certification. A certificate of LEED noncompliance shall be for a period not to exceed three (3) months and may be renewed as necessary to achieve certification. The fee for noncompliance shall be issued every time the certificate is issued for up to ten years.
- The fee for a certificate of LEED noncompliance shall be based on the following formula: $F = [(CN-CE)/CN] \times CV \times 0.0075$, where:
 - F is the fee;
 - CN is the minimum number of credits to earn the level of LEED certification for which the project was pre-certified;
 - CE is the number of credits earned as documented by the report; and
 - CV is the Construction Value as set forth on the building permit for the structure.

Section IV: General Standards

Bonus Height Program

Pervious Surface

The integration of pervious surfaces into site design and building design benefits the individual development, the neighborhood and the city. Pervious surfaces can reduce stormwater runoff, flood risk, irrigation needs and the burden on infrastructure. Examples of pervious surfaces include pervious pavement, green roofs, bio-swales, landscaping, and green screens. As technology in this field advances, additional pervious surfaces may meet the intent of this standard.

- The number of square feet of Bonus Height shall be twice that of the number of square feet of Pervious Surface. The additional square footage may be used to the Bonus Height Maximum as determined on the BHP Chart.
- Green roofs that are utilized to meet LEED certification may not be “double counted” for both the LEED height bonus and the Pervious Surface height bonus. If the level of LEED certification would be met without the green roof, then the green roof may be counted for the Pervious Surface height bonus.
- The binding commitments shall consist of an instrument recorded in the register of deeds, that records the transferred bonus height and square feet calculations as first certified by the Planning Commission; records the preservation of the historic building in perpetuity by requiring that any exterior alterations including demolition in whole or in-part be reviewed and approved by the Metro Historic Zoning Commission following the Commission’s processes, policies, Secretary of Interior’s Standards and any applicable design guidelines; record the forfeiture or any future claim for additional building intensity of development, including any type of variance of the preserved historic building; and records the project’s and / or receiving site’s additional square feet and building height bonus derived from the transfer.

Within a Historic Overlay or Landmark District, existing buildings are eligible to transfer any unused DTC height entitlements based on the square foot calculations outlined in this section, and are subject to the BHP provisions and chart.

Historic Building Preservation

The preservation and re-use of Downtown’s historic buildings is critical to maintaining the character and identity of Nashville. Use of this bonus shall require a recommendation from the Metropolitan Historical Commission, or its designee, on the worthiness of preserving a building outside of a Historic Overlay District, including but not limited to buildings worthy of conservation, and buildings listed on or eligible to be listed on the National Register of Historic Places. A recommendation shall also be provided on the square feet of the preserved historic building footprint.

- The number of square feet of Bonus Height shall be equal to the development rights being forfeited by the preservation of the building, calculated as follows: the number of by-right stories permitted minus the number of stories of the historic building, multiplied by the square feet of the historic building footprint. The additional square footage may be used to the Bonus Height Maximum as determined on the BHP Chart.

Section IV: General Standards

Bonus Height Program

Publicly-Accessible Open Space

Accessible, enjoyable open spaces are essential for vital and functioning neighborhoods. Open space provides the community with opportunities to be in an outdoor setting, while encouraging social interaction. See the BHP Chart for details for a list of Subdistricts in which the Open Space bonus may be utilized.

Open Space must be designed to the open space standards of the DTC. To be eligible for the Height Bonus, open space must be a minimum of $\frac{1}{4}$ acre in area.

- Plazas are not eligible for the BHP.
- In Open Space deficiency areas (See the Open Space section of the General Standards), the number of square feet of Bonus Height shall be seven times that of the number of square feet in open space. Outside of Open Space deficiency areas, the number of square feet of Bonus Height shall be four times that of the number of square feet in open space. The additional square footage may be used to the Bonus Height Maximum as determined on the BHP Chart.
- Bonuses are available only for publicly accessible (whether publicly or privately owned) open space.

Inclusionary Housing

Bonus Height is available for compliance with section 17.40.780 of the Zoning Code, as shown in the Bonus Height Program (BHP) Chart.

DRAFT

Section IV: General Standards

Bonus Height Program

Civil Support Space

The dedication of Civil Support Space offers height bonus for the developer's contribution of space to a specific use or entity that serves to better the neighborhood or community. See the BHP Chart for details for a list of Subdistricts in which the Civil Support Space bonus may be utilized.

- Civil Support Space is typically on the ground level. Upper levels may be appropriate depending on the intended use.
- The number of square feet of Bonus Height shall be twice that of the number of square feet donated to Civil Support Space. The additional square footage may be used to the Bonus Height Maximum as determined on the BHP Chart.
- Civil Support Space shall be dedicated to the chosen use or uses for 15 years. Adherence to this standard shall be checked yearly by the Planning Commission or its designee.

The Planning Commission may require the developer to execute an agreement, restrictive covenant, or other binding restriction on land use that preserves the use of Civil Support Space for the required period before final site plan review.

The following uses are appropriate for Civil Support Spaces:

- Institutional Uses
 - Cultural center
 - Day care center
 - School day care
- Education
 - Community education
- Transportation Uses
 - Water taxi station
- Waste Management Uses
 - Recycling collection center
- Recreational and Entertainment Uses
 - Community playground
- Other Uses
 - Community garden

Other uses may be appropriate for Civil Support Space. The applicant may propose a different use for Civil Support Space to be approved by the Planning Commission.

Upper Level Garage Liner and Underground Parking

The public realm of the streetscape is improved by providing parking in underground structures and lining above ground parking structures with habitable space. See the BHP Chart for a list of Subdistricts in which the Garage Liner and Underground Parking bonuses may be utilized.

- Height bonuses are given for upper levels of habitable space, a minimum of 20' in depth, which masks a parking structure from view along public streets and open space. The minimum depth may be reduced by the Planning Commission provided the intent of an active streetscape is met.
- The number of square feet of Bonus Height shall be twice that of the number of square feet in Garage Liners. The additional square footage may be used to the Bonus Height Maximum as determined on the BHP Chart.
- The number of square feet of Bonus Height shall be equal to the number of square feet in Underground Parking. The additional square footage may be used to the Bonus Height Maximum as determined on the BHP Chart.
- Height bonuses are not given for ground level liners, or upper level liners that are required by the DTC.

Public Parking

Parking accessible to the general public is important to the continued growth and vitality of Downtown. See the BHP Chart for a list of Subdistricts in which the Public Parking bonuses may be utilized.

- The number of square feet of Bonus Height shall be twice that of the number of square feet in Public Parking. The additional square footage may be used to the Bonus Height Maximum as determined on the BHP Chart.
- Public Parking shall be clearly marked as public, and shall be accessible to the public, at all hours that the garage is open, for the lifetime of the building.

This page left intentionally blank

DRAFT

Section IV: General Standards

Bonus Height Chart

Maximum height within the Subdistrict	LEED	LEED ND	Pervious Surface	Historic Building Preservation	Open Space	Inclusionary Housing	Civil Support Space	Upper Level Garage Liner & Underground Parking	Public Parking	Bonus Height Maximum	
Central											
James Robertson	elevation of 560'	Any = 2 stories	2 stories	2 stories	2 stories	2 stories	No bonus	2 stories below 560' elevation	2 stories below 560' elevation	2 stories	elevation 560'
Core											
Core	30 stories	Silver = 4 stories; Gold = 8 stories Platinum = 12 stories	2 stories	2 stories	8 stories	8 stories	Unlimited	8 stories	8 stories	2 stories	Unlimited
Core-historic	6 stories on the interior of blocks; 10 stories on the corners	No bonus	No bonus	No bonus	4 stories	No bonus	4 stories	No bonus	No bonus	No bonus	10 stories
Upper Broadway											
Upper Broadway	100'	No bonus	No bonus	No bonus	No bonus	No bonus	No bonus	No bonus	No bonus	No bonus	100'
Second and Broadway											
Second	8 stories within 105'	No bonus	No bonus	No bonus	No bonus	No bonus	No bonus	No bonus	No bonus	No bonus	8 stories within 105'
Broadway	5 stories within 65'	No bonus	No bonus	No bonus	No bonus	No bonus	No bonus	No bonus	No bonus	No bonus	5 stories within 65'
SoBro											
General, or 8th Avenue frontage south of roundabout (beyond 100' from frontage)	30 stories	Silver = 4 stories; Gold = 8 stories Platinum = 12 stories	2 stories	2 stories	8 stories	8 stories	Unlimited	8 stories	8 stories	2 stories	Unlimited
West side of 1st and East side of 2nd	15 stories	Silver = 4 stories; Gold = 8 stories Platinum = 12 stories	2 stories	2 stories	5 stories	5 stories	15 stories	5 stories	5 stories	2 stories	30 stories
8th Avenue frontage south of roundabout (within 100' frontage)	8 stories	Any = 2 stories	2 stories	2 stories	2 stories	2 stories	3 stories	2 stories	2 stories	2 stories	11 stories
River											
River	10 stories	No bonus	No bonus	No bonus	No bonus	No bonus	No bonus	No bonus	No bonus	No bonus	10 stories
South											
Lafayette											
General	8 stories	Any = 2 stories	2 stories	2 stories	2 stories	2 stories	3 stories	2 stories	2 stories	2 stories	11 stories
Transitional Properties	15 stories	Any = 2 stories	2 stories	2 stories	3 stories	3 stories	3 stories	3 stories	3 stories	2 stories	18 stories
Lafayette Street	12 stories	Any = 2 stories	2 stories	2 stories	3 stories	3 stories	4 stories	3 stories	3 stories	2 stories	16 stories
Rutledge Hill											
Primary and Secondary	6 stories	Any = 1 story	1 story	1 story	1 story	1 story	1 story	1 story	1 story	2 stories	7 stories
Tertiary	3 stories	No bonus	No bonus	No bonus	No bonus	No bonus	No Bonus	No bonus	No bonus	No bonus	3 stories
Rolling Mill Hill											
Rolling Mill Hill	65 feet with an SEP of 1:1.5	No bonus	No bonus	No bonus	No bonus	No bonus	No Bonus	No bonus	No bonus	No bonus	65 feet with an SEP of 1:1.5
Rutledge River											
Rutledge River	9 stories	Any = 2 stories	2 stories	2 stories	2 stories	2 stories	3 stories	2 stories	2 stories	2 stories	12 stories
West											
Gulch North											
General	7 stories	Any = 2 stories	2 stories	2 stories	2 stories	2 stories	3 stories	2 stories	2 stories	2 stories	10 stories below 560' elevation
fronting Herman Street	4 stories	No bonus	No bonus	No bonus	No bonus	No bonus	No Bonus	No bonus	No bonus	2 stories	4 stories
Gulch South											
General	10 stories	Any = 2 stories	2 stories	2 stories	2 stories	2 stories	6 stories	2 stories	2 stories	2 stories	16 stories
fronting Church, Broadway, Demonbreun	15 stories	Any = 2 stories	2 stories	2 stories	3 stories	3 stories	6 stories	3 stories	3 stories	2 stories	21 stories
at key intersections	20 stories	Silver or Gold = 2 stories; Platinum = 3 stories	2 stories	2 stories	4 stories	4 stories	8 stories	4 stories	4 stories	2 stories	28 stories
North											
Hope Gardens											
Primary	7 stories	Any = 1 story	1 story	1 story	1 story	1 story	1 story	1 story	1 story	1 story	8 stories
Secondary	4 stories	Any = 1 story	1 story	1 story	1 story	1 story	1 story	1 story	1 story	1 story	5 stories
Tertiary	3 stories	No bonus	No bonus	No bonus	No bonus	No bonus	No Bonus	No bonus	No bonus	No Bonus	3 stories
Sulphur Dell											
Primary	7 stories	Any = 1 story	1 story	1 story	1 story	1 story	1 story	Any = 1 story	1 story	1 story	8 stories
Secondary	5 stories	Any = 1 story	1 story	1 story	1 story	1 story	1 story	Any = 1 story	1 story	1 story	6 stories
Tertiary	4 stories	Any = 1 story	1 story	1 story	1 story	1 story	1 story	Any = 1 story	1 story	1 story	5 stories

Section V
SIGN STANDARDS

DRAFT

This page left intentionally blank

DRAFT

Section V: Sign Standards

Introductory Provisions

Intent

The purpose of these regulations is to set specific sign standards that accomplish the following:

- Establish reasonable and improved standards for Downtown business identification;
- Encourage creative and innovative approaches to regulating signs consistent with the principles of the Downtown Community Plan;
- Promote economic vitality in Downtown;
- Enhance the overall visual environment in Downtown by discouraging signs that contribute to the visual clutter of the streetscape;
- Ensure signs are designed for the purpose of identifying a business in an attractive and functional manner; and
- Ensure signs reinforce the existing and envisioned character and are complementary to the architectural design of Downtown.

Applicability

- These sign regulations apply to all properties zoned DTC and are not in an Historic Zoning Overlay. See map on Page 107.
- In addition to the standards set forth within this section, the following Sections of the Metro Zoning Code shall apply to all regulated signage within the DTC.
 - Section 17.04.06 - Definitions of general terms
 - Within Chapter 17.32 SIGN REGULATIONS:
 - Section 17.32.020 - General Provisions
 - Section 17.32.040 - Signs allowed without a permit
 - Section 17.32.050 - Prohibited signs
 - Section 17.32.060 - Permitted on-premises temporary signs
 - Section 17.32.145 - Landmark signs
 - Section 17.32.160 - Computations
 - Within Article XI. Sign Procedures
 - 17.40.490 - Permits and compliance tag.
 - 17.40.510 - Unsafe, illegal, dilapidated and abandoned signs

Sign Permit Applications

Applications for sign permits shall be made with and reviewed by the Codes Department. All sign applications that do not involve Modifications shall only require Codes Department approval, regardless of whether the property is subject to additional design guidelines (e.g. MDHA redevelopment districts).

Applicants for sign permits shall submit the following information. Incomplete applications will not be accepted.

- Design and details of the signage depicting size and shape (including height, width and depth), anchoring, materials, lighting and other data necessary to determine compliance with the requirements of this section and with the requirements of the Metropolitan building code and the Metropolitan electrical code. Additional information may be required by Codes.
- Drawings and specifications, including building elevations or artist's rendering depicting the sign faces, and dimensions indicating sign placement on the building.
 - For ground signs and signs seeking a ROW encroachment, the distance of the signs from the corner of the building or property line should be included.
- A site plan, drawn to scale, depicting the location of the proposed signage and all relevant features of the site, including location and size of other regulated signs.
- The property address, applicant and sign designer's name and contact information.

Common Sign Plan

A common signage plan regulates signage for multiple businesses or tenants within one building or complex. A common sign plan is mandatory for all new developments and sign Modifications.

- A common signage plan shall provide for consistency among signs with regard to at least four of the following: materials; location of each sign on the building; sign proportions; color scheme; lighting; lettering or graphic style.
- The common signage plan shall establish an allowable area of signage for existing and future tenants with regard to all allowed signs types.
- The common signage plan shall indicate existing nonconforming signs as well as the amount and location of on-premises signage to be allocated to each tenant under the new plan.

Section V: Sign Standards

Modifications

Sign Permit Modifications

Requests for modifications to sign standards are reviewed through the process outlined on pages 14 and 15.

Modifications are reviewed by Planning staff and either the MDHA Design Review Committee or the DTC Design Review Committee. The applicant may appeal a decision through the process described on pages 14 and 15. All sign Modifications are Major Modifications. Two additional types of Modifications for signage related permits may be requested and are outlined below.

Modifications for Exceptional Design

Creative signage that does not fit the specific regulations of this section may be considered by the appropriate reviewing body (listed above), based on its merits, as they relate to all of the following design criteria:

- architecture
- the configuration or location of the building or property
- building scale
- legibility
- technical competence and quality in design, construction and durability

Applications for this type of Modification require submittal of a common sign plan for the property in question. Approval of any related structures (i.e. canopy) will require review by all applicable agencies. Exceptional design modifications shall not permit electronic changeable copy where it is otherwise not permitted.

Modifications for Tourist-oriented Businesses

Tourist-oriented businesses within DTC zoning may receive Modifications to allow greater sign area and use of digital technology. To qualify as a tourist-oriented business a business shall:

- have a minimum permanent fixed seating capacity of 500; and
- offer lawful activities or services to the general public of cultural, historical, recreational, educational, or entertainment purposes.

Applications for this type of Modification require submittal of a common sign plan for the property in question. Approval of any related structures (e.g. canopy) will require review by all applicable agencies. Tourist-oriented business Modifications shall be reviewed according to the design criteria listed under Modifications for Exceptional Design, above, in addition to the following:

- Large electronic or illuminated signs shall not adversely impact residential or hotel uses.
- All signs shall conform to the lighting standards of the DTC.
- See page 119 for additional information on changeable copy.

Right-of-way Encroachments

Where a sign is proposed to encroach into the public right-of-way an application shall be made with the Public Works Department in addition to the sign permit application with the Codes Department. Both applications shall include the requirements of the Public Works Department available at their website: <http://www.nashville.gov/pw/permits.asp>, in addition to the submittal requirements listed on the previous page.

Nonconforming Signs

Nonconforming Signs

Sections 17.40.660 and 17.40.690 of the Metro Zoning Code apply. This section further clarifies them.

Building Signs

A sign shall be brought into compliance with the provisions of the above mentioned sections if a sign permit is required to rebuild the sign. This does not include a panel change in a non-conforming cabinet sign, which shall be permitted. All new panels shall conform to all illumination standards herein.

Ground Signs

An existing ground sign may change the face or panel of a sign that does not meet the area or height standards within this section. However, in no instance shall there be an increase in the degree of nonconformity. All new panels shall conform to all illumination standards herein.

A sign shall be brought into compliance with the provisions of this title if at any time the sign is altered, repaired, restored or rebuilt to the extent that the cost exceeds fifty percent (50%) of the estimated replacement cost of the sign (in current dollar value). All permits within any six consecutive calendar months shall be aggregated for purposes of measuring the fifty percent standard.

Repair and Maintenance

If the alteration or repair is caused by involuntary damage or casualty, the sign may be altered or repaired to its pre-damaged condition.

A sign may be removed and taken off-site for repair and maintenance. The sign must be returned to the original location within 120 days of removal.

Section V: Sign Standards

General Standards

Materials

All permanent, on-premises signs shall be constructed of a rigid, weatherable material such as hard plastic, wood, MDO plywood, aluminum, steel, PVC, glass and/or Plexiglas. On-premises, permanent signs shall not be constructed of nonrigid materials including, but not limited to, vinyl, fabric, canvas, or corrugated plastic. The provisions of this subsection shall not apply to approved, permitted canopies, awnings, and porticoes.

Voluntary Removal of a Legally Non-conforming Ground Sign

Any property voluntarily removing a legally non-conforming ground sign shall be permitted to a bonus to one hundred fifty percent (150%) of the building signs allocated to the property. For example, if a property is allocated 200 sq ft of building signs, the property will be allowed 300 sq ft of buildings signs if a legally non-conforming ground sign is removed.

Building Facade and Street Frontage Measurement

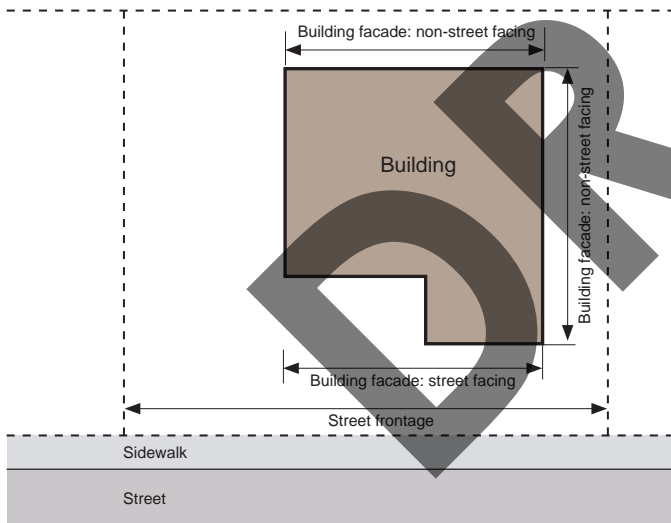

Other Sign Types

Non Street-Facing Signs

Non street-facing building facades and alley frontages, not otherwise regulated, are allocated 1 square foot of sign area per 1 linear foot of building facade, to a maximum of the sign area permitted for the primary street frontage.

This includes lots adjoining open spaces, pedestrian walkways, or parking areas. Ground signs are not permitted on non street-facing building facades or alley frontages.

Temporary Signs

Temporary signs shall follow the standards of 17.32.060.

Murals

Only the company name, text relating directly to products or services sold on site, and logos shall count toward the sign area allocation. Otherwise, murals are exempt from this code.

Auto-oriented canopy/awning Signs

The allocation of signage for auto-oriented canopies and awnings shall be measured as walls signs and shall only be used on the canopy/awning. See the Auto-oriented Canopies and Awnings section of the Downtown Code for information on the design of canopies and awnings.

Parking Lot Signs

A pole-mounted projecting sign is allowed for surface parking lots with no associated building. One sign per street frontage is allowed. The maximum size shall be 36 square feet per sign. The side of the sign shall be attached to the pole, and the pole will be considered the "building facade". All projecting sign standards shall apply (Page 114); parking lot signs shall follow the standards of a 1-story building.

Section V: Sign Standards

Street Types

Pedestrian Streets

- Pedestrian streets are roadways with high pedestrian activity and slower moving vehicular traffic. Buildings along these streets are located at the back of the sidewalk creating a streetscape with active uses including retail, office and entertainment businesses.
- Pedestrian streets are generally located in the Downtown core, where more of the original street wall remains intact, and less opportunities exist for surface parking.
- Some streets outside of the Downtown core, such as Korean Veterans Boulevard (KVB), require Pedestrian designation. The MDHA and UDO standards for KVB require pedestrian-focused building design and streetscape. The standards for Pedestrian Street signage allow greater flexibility for such streets.

Gateway Streets

- Gateway streets are wider roadways that serve pedestrians, but focus primarily on automobile traffic and typically carry traffic at higher speeds than Pedestrian Streets.
- Generally located on the fringe of Downtown, Gateway streets serve as the key automobile entry points into Downtown.

Transitional Streets

- Transitional streets currently contain a mix of different building characters, transitioning from more auto oriented buildings and uses to a more mixed use pedestrian environment.
- As these street redevelop, buildings will be sited close to the sidewalk with a more pedestrian focus.

Interstate

- Many properties are visible from the interstate loop which moves vehicles into and through Downtown.
- The opportunity to advertise to the interstate must be balanced with the safety of drivers and preservation of Nashville's iconic skyline.

Printers' Alley

- Printers' Alley is a unique, iconic alley in Downtown. As a public, pedestrian-only street with businesses on the ground floor and upper floors, unconventional standards apply to this street only.



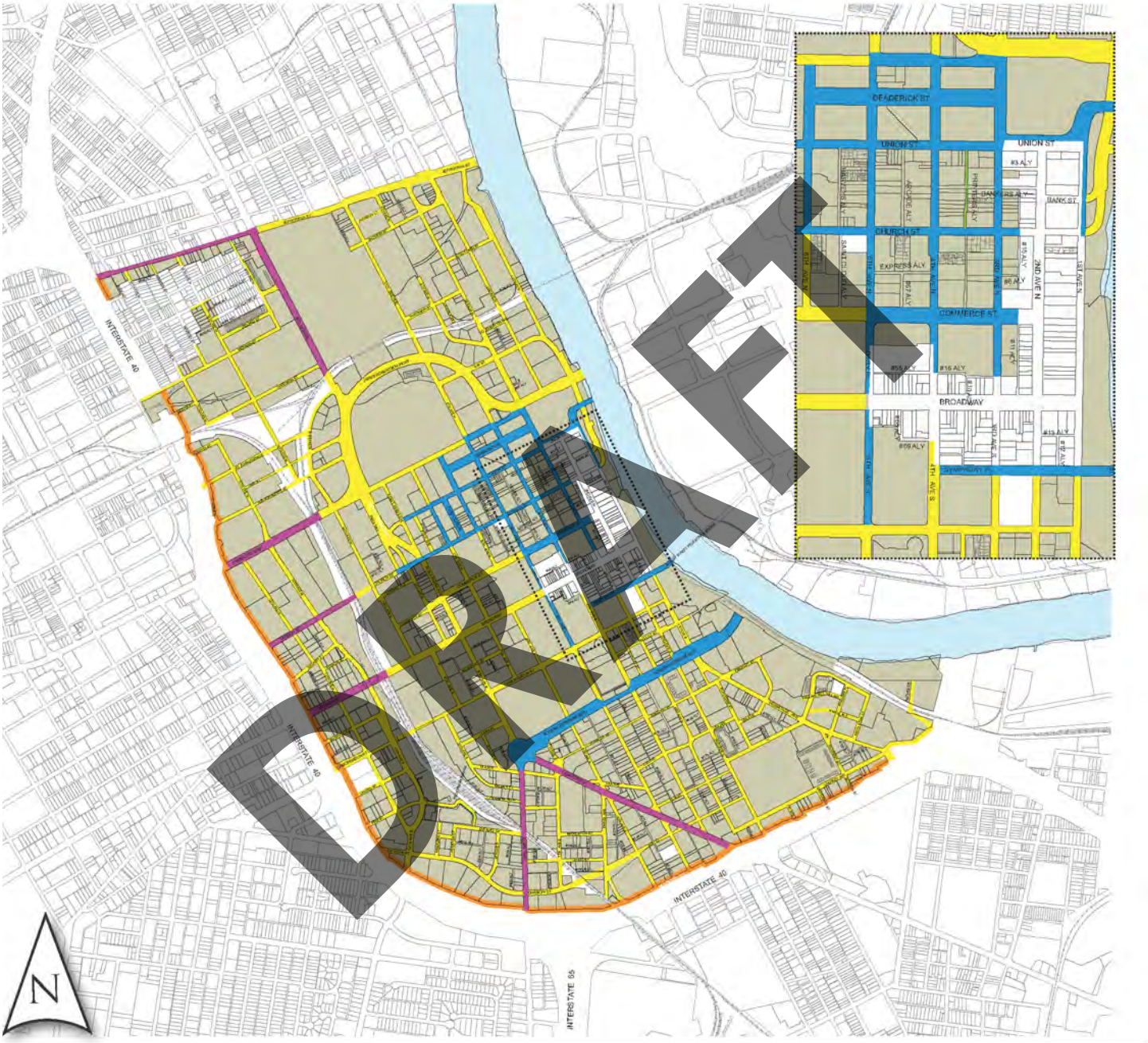

DRAFT

Section V: Sign Standards

Signs: Map of Street Types for Signage Standards



Legend

	Transitional Street		Interstate
	Pedestrian Street		Printers' Alley
	Gateway Street		Applicable properties

- New streets that are not in existence as of the adoption of this ordinance shall be categorized as Transitional Streets.
- Properties within an Historic Zoning Overlay and/or with SP zoning are not subject to the sign standards of DTC zoning.

Section V: Sign Standards

Determining Sign Entitlements

Use this page as a guide to determine the sign entitlements of a property. You will need to know the length of the building on all street frontages, the length of alley frontages, and the length of all interior property lines.

STEP 1

What Street Types is the property on? Page 107

- Pedestrian
- Transitional
- Gateway
- Interstate
- Printers' Alley

STEP 2

How much square footage of signage is allowed? Pages 109-110

- Pedestrian
 - Building _____
 - Ground _____
 - Skyline _____
- Transitional
 - Building _____
 - Ground _____
 - Skyline _____
- Gateway
 - Building _____
 - Ground _____
 - Skyline _____
- Interstate
 - Building _____
 - Skyline _____
- Printers' Alley
 - Building _____
 - Skyline _____

STEP 3

What are the standards for the signs? Pages 111-117

STEP 4

What are the illumination standards for signs? Pages 118-119

STEP 5

Is changeable copy allowed? Page 119

STEP 6

- For a multi-tenant development: submit a Common Sign Plan to the Codes Department. Page 103
- For an individual tenant: submit a Sign Plan Proposal to the Codes Department. Page 103
- Additional types of signs may be allowed, depending on site conditions. Page 105

KEEP IN MIND

- There is no limit to the number of Building Signs per property.
- Sign entitlements are limited only by the total amount of square footage of signs allowed on the property, the maximum sizes of signs and the required placement of signs.
 - For example, if a building is allowed 100 sq ft of Building Signs, that can be used in one 100 sq ft sign or in five 20 sq ft signs. The only limit is the maximum dimensions of the sign type.
- Non street-facing facades are allowed signs. Page 105
- Contact the Codes Department with questions.

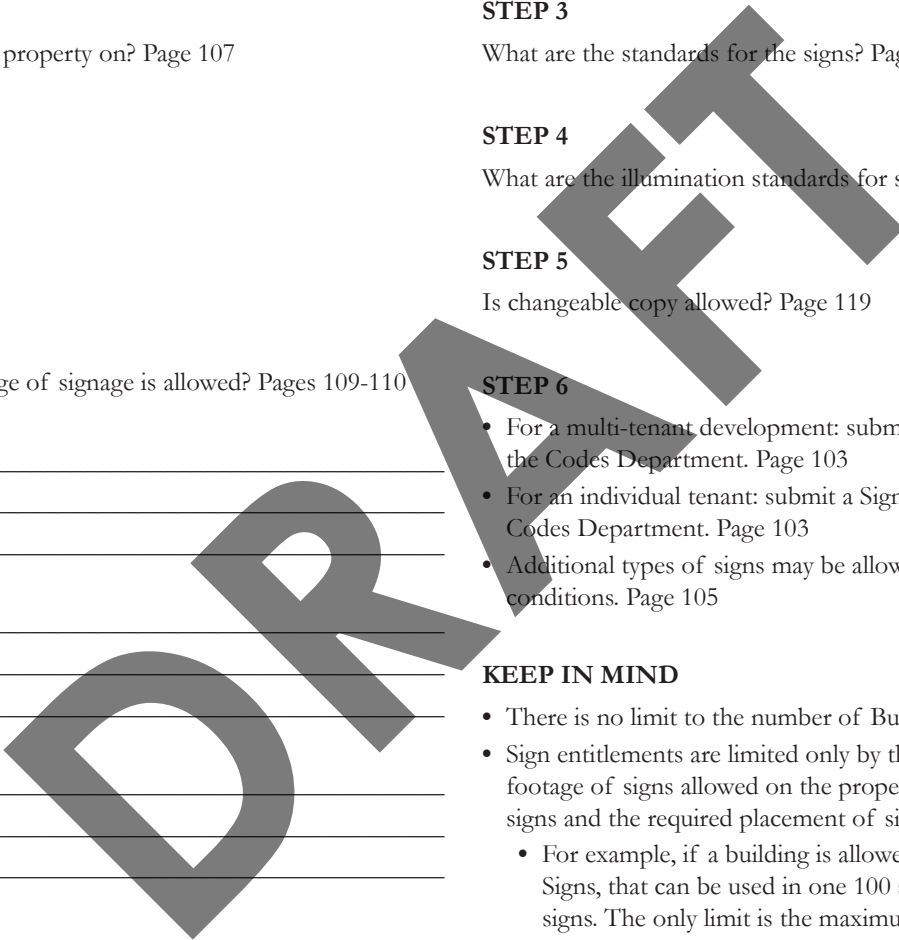

Section V: Sign Standards

Allocation of Sign Area by Street Type

The maximum sign area for each type of sign is determined by the Street Type and is established in the following tables. Specific requirements for each sign type are shown on the subsequent pages.

For each cell in the table below, there is a maximum allowed sign area that may be utilized with any combination and any number of signs associated with that cell, unless otherwise noted.

The measurements for "linear feet" shall be at grade.

	Pedestrian Street Type		Transitional Street Type
Building Signs		Building Signs	
Wall Sign	1.5 square foot of sign area per 1 linear foot of building facade or 36 square feet, whichever is greater.	Wall Sign	1.5 square foot of sign area per 1 linear foot of building facade or 36 square feet, whichever is greater.
Awning Sign	When a Projecting Sign is used on the building, an additional 0.5 square feet of sign area per 1 linear foot of building facade shall be permitted, for a total of 2.0 square feet per 1 linear feet of building facade.	Awning Sign	Where no ground sign exists, an additional 0.5 square feet of sign area per 1 linear foot of building facade shall be permitted for a total of 2.0 square feet per 1 linear feet of building facade.
Canopy Sign		Canopy Sign	
Projecting Sign		Projecting Sign	
Shingle Sign	9 square feet per sign	Shingle Sign	9 square feet per sign
Ground Signs		Ground Signs	
Monument Sign	24 square feet	Monument Sign	32 square feet Properties with 300 or more feet of frontage are allowed one additional monument sign of an additional 32 square feet
Skyline Signs - area determined by average height of building		Skyline Signs - area determined by average height of building	
75' to 100'	480 square feet	75' to 100'	480 square feet
101' - 200'	600 square feet	101' - 200'	600 square feet
201' and taller	720 square feet	201' and taller	720 square feet
	Gateway Street Type		
Building Signs			
Wall Sign	1.5 square foot of sign area per 1 linear foot of building facade or 36 square feet, whichever is greater.		
Awning Sign	Where no ground sign exists, an additional 0.5 square feet of sign area per 1 linear foot of building facade shall be permitted, for a total of 2.0 square feet per 1 linear feet of building facade.		
Canopy Sign			
Projecting Sign			
Shingle Sign	9 square feet per sign		
Ground Signs			
Monument Sign	64 square feet Properties with 300 or more feet of frontage are allowed one additional monument sign of an additional 64 square feet		
Skyline Signs - area determined by average height of building			
75' to 100'	480 square feet		
101' - 200'	600 square feet		
201' and taller	720 square feet		

**** More Street Types on next page****

Section V: Sign Standards

Allocation of Sign Area by Street Type

The maximum sign area for each type of sign is determined by the Street Type and is established in the following tables. Specific requirements for each sign type are shown on the subsequent pages.

For each cell in the table below, there is a maximum allowed sign area that may be utilized with any combination and any number of signs associated with that cell, unless otherwise noted.

The measurements for "linear feet" shall be at grade.

Interstate Street Type	
Building Signs	
Wall Sign	1 square foot of sign area per 1 linear foot of street frontage
Awning Sign	
Canopy Sign	
Projecting Sign	
Shingle Sign	9 square feet per sign
Ground Signs	Not allowed
Skyline Signs - area determined by average height of building	
75' to 100'	480 square feet
101' - 200'	600 square feet
201' and taller	720 square feet

Printers' Alley Street Type	
Building Signs	
Wall Sign	Ground floor: 2.0 square foot of sign area per 1 linear foot of street frontage Second floor: 1.5 square foot of sign area per 1 linear foot of street frontage Upper floors: 1 square foot of sign area per 1 linear foot of street frontage Signage allowed for each floor shall be used on that floor and shall not be redistributed to other parts of the building.
Awning Sign	
Canopy Sign	
Projecting Sign	
Shingle Sign	
Ground Signs	Not allowed
Skyline Signs - area determined by average height of building	
75' to 100'	480 square feet
101' - 200'	600 square feet
201' and taller	720 square feet

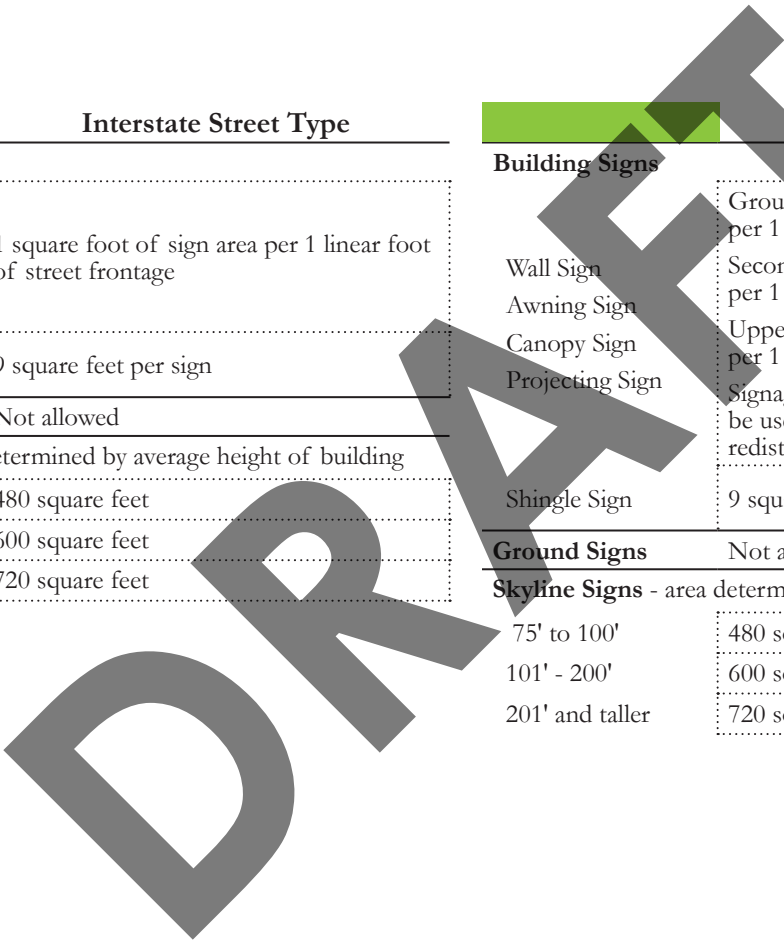

Section V: Sign Standards

Building Sign: Wall Sign

Description

A wall sign is a building sign that is attached flat to, or mounted away from but parallel to, the building facade.

A wall sign may be painted on the building facade.

General Provisions

- A wall sign shall either be located lower than the window sills of the third story or at the top of the building, not to be placed below the windows of the highest floor.
- No portion of a wall sign may extend above the roof line or above a parapet wall of a building with a flat roof.
- No portion of a wall sign may extend above the lower eave line of a building with a pitched roof.
- A wall sign cannot cover windows or architectural details.
- An exposed raceway shall be finished to match the background wall or be integrated into the overall design of the sign.
- A wall sign can be externally or internally illuminated in accordance with pages 118.



Design Standards

- | | |
|---------------------------------|--|
| Ⓐ Overall area allocation (max) | See pages 109-110 |
| Ⓑ Projection (max) | 13 inches |
| Ⓒ Exposed Raceway height (max) | 50% of the letter height, OR if the Raceway is used as the sign background, the Raceway may extend 3 inches beyond the largest part of the sign. |

Refer to the Illumination section (pages 118) for additional raceways standards and permitted locations.



Example of raceway incorporated as sign background

Section V: Sign Standards

Building Sign: Awning Sign

Description

An awning sign is a type of building sign. Graphics and symbols are painted, sewn, or otherwise adhered to the awning material as an integrated part of the awning itself.

General Provisions

- Only awnings on first and second story windows may contain signs.
- A maximum of one sign is allowed per awning face.
- An awning sign may only be externally illuminated.
- See the Awnings section of the Downtown Code for additional information on the design of awnings.

Design Standards

- | | |
|---|-------------------|
| Ⓐ Overall area allocation (max) | See pages 109-110 |
| Ⓑ Sign Width
(max % of awning width/depth) | 75% |
| Ⓒ Height of text and graphics on valance
(max) | 2 feet |
| Ⓓ Max area of sloping plane covered by sign | 50% |

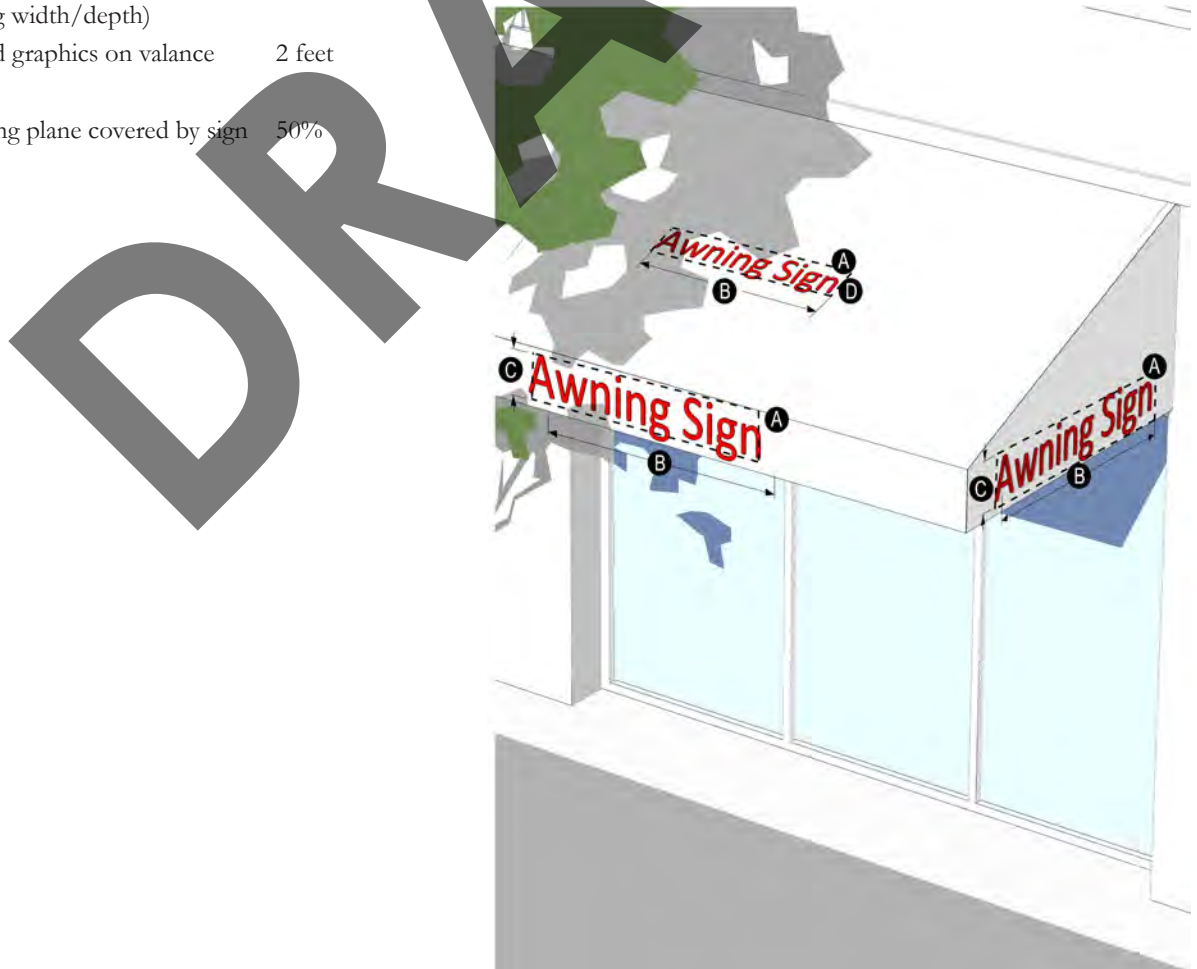
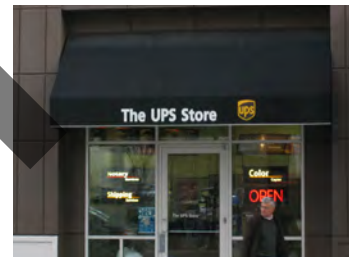

Section V: Sign Standards

Building Sign: Canopy Sign

Description

A canopy sign is a type of building sign that is attached above, below or to the face of a canopy.

General Provisions

- A canopy sign cannot extend outside the overall length or width of the canopy. However, a canopy sign may extend above or below the canopy provided the sign meets all other design standards.
- Maximum of one sign per canopy face.
- Raceways are permitted for signs extending below or above the canopy.
- A canopy sign can be externally or internally illuminated in accordance with page 118.
- Cabinet signs are not permitted as canopy signs.

See the Canopies section of the Downtown Code for additional information on the design of canopies.

- This definition does not include freestanding canopies over fuel pumps. See the Auto-oriented canopy/awning Signs on page 105.

Design Standards

- A Overall area allocation (max) See pages 109-110
- B Sign Width (max % of canopy length or depth) 75%
- C Height of text and graphics (max) 2 feet
- D Depth (max) 13 inches
- E Exposed Raceway height (max) 50% of the letter height, OR if the Raceway is used as the sign background, the Raceway may extend 3 inches beyond the largest part of the sign.

Refer to the Illumination section (pages 118) for additional raceways standards and permitted locations.

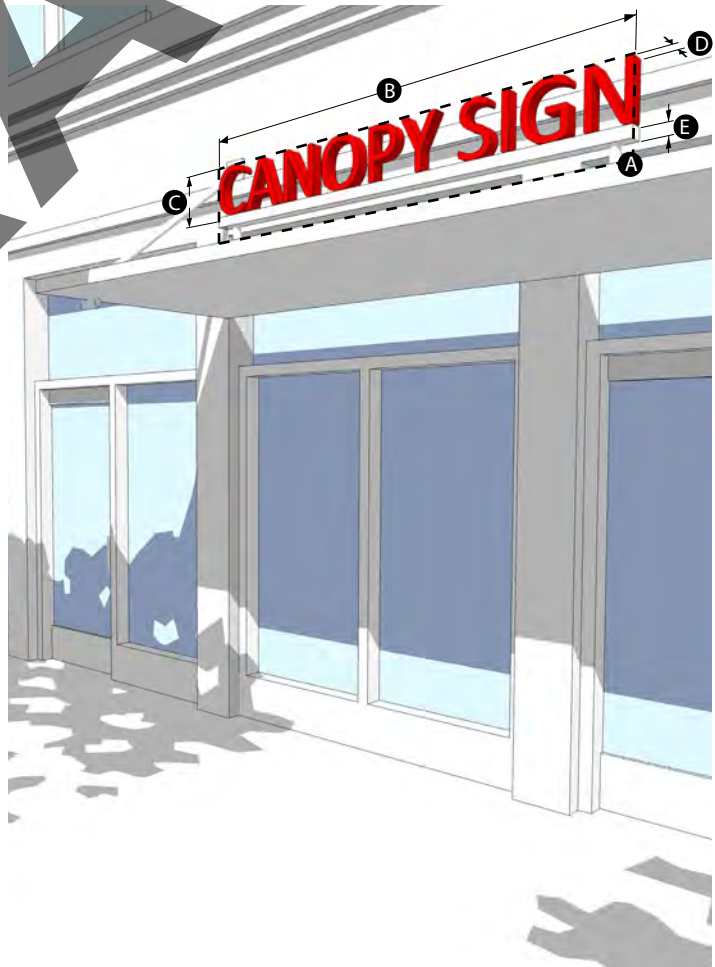
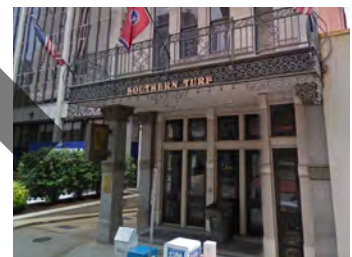

Section V: Sign Standards

Building Sign: Projecting Sign

Description

A projecting sign is a type of building sign that projects outward from the facade, typically at a ninety degree angle. Projecting signs are typically, but not always, vertically oriented and generally mounted above the first floor.

General Provisions

- A projecting sign must be located at least 25 feet from any other projecting sign. When building width prohibits adherence to this standard, flexibility shall be permitted through a Minor Modification to be reviewed by staff.
- A projecting sign may be erected on a building corner when the building corner adjoins the intersection of two streets. Allocation of sign area from both streets may be used, however, in no case shall the sign exceed the maximum dimensional standards below.
- A projecting sign shall be located below the window sills of the fourth story.
- The top of a projecting sign shall not extend above the building eave or top of parapet, except on one story buildings where the top of a projecting sign may have a maximum of 20% of the sign height above the top of the building.
- A projecting sign can be externally or internally illuminated in accordance with pages 118.



Design Standards

A	Overall area allocation (max)	See pages 109-110
B	Height (max)	
	1 story buildings	10 feet
	2 and 3 story buildings	16 feet
	4 or more story buildings	20 feet
C	Spacing from facade (min)	1 foot
D	Projection Width (max)	6 feet
E	Depth of cabinet (max)	18 inches

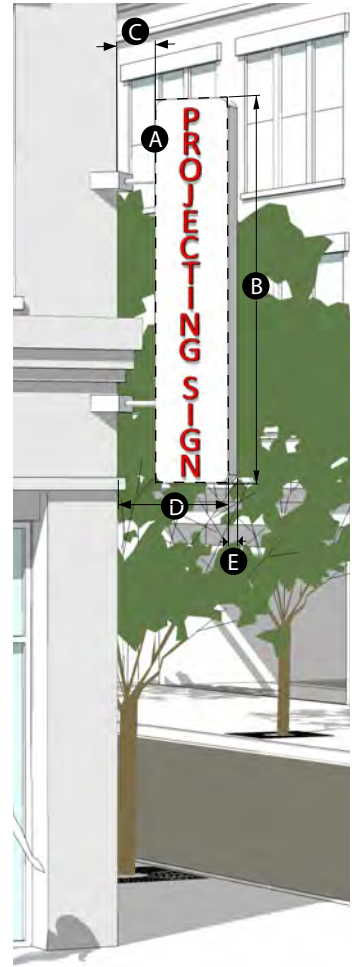

Section V: Sign Standards

Building Sign: Shingle Sign

Description

A shingle sign is a smaller building sign that projects outward, typically at a ninety degree angle, and hangs from a bracket or support that is located over or near a building entrance.

General Provisions

- Signs shall be located within 8 feet of an active pedestrian building entrance. This does not include service entries or entries that primarily remain locked.
- An active pedestrian entrance at the corner of a building is allowed signs on both streets.
- A shingle sign shall be located below the window sills of the second story.
- A shingle sign shall not be internally illuminated.



Design Standards

- | | |
|-----------------------------|---------------|
| Ⓐ Area (max) | 9 square feet |
| Ⓑ Height (max) | 3 feet |
| Ⓒ Spacing from facade (min) | 6 inches |
| Ⓓ Width (max) | 3 feet |
| Ⓔ Depth (max) | 6 inches |



Section V: Sign Standards

Ground Sign: Monument Sign

Description

A monument sign is a ground sign that is attached along its entire length to a continuous pedestal.

General Provisions

- Each property fronting on a Street Type which allows a monument sign is permitted one per street frontage. One additional monument sign is allowed for properties with 300 or more feet of street frontage on one street. Where more than one sign is permitted, signs along the same street frontage shall be spaced a minimum of 200 feet apart.
- A monument sign must be set back at least 5 feet from the front property line.
- A sign erected on the top of a retaining wall is required to meet the standards for a monument sign. The height of the wall shall be included in the overall height calculation. In this case, the 5 foot minimum setback is not required.
- A sign affixed to the face of a retaining wall or seat wall that is an integral part of a plaza or streetscape design may utilize the sign area allocated to wall signs. In this case, the 5 foot minimum setback is not required.
- A monument sign can be externally or internally illuminated in accordance with page 118.

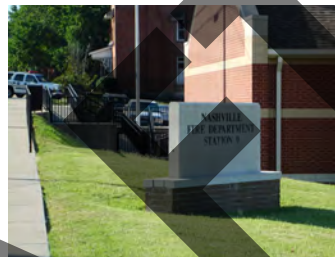
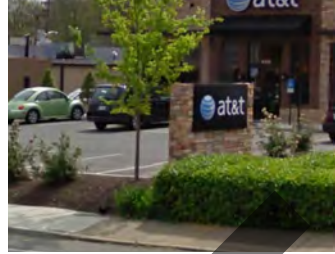

Design Standards

- | | |
|-----------------------------------|-------------------|
| A Sign area (max per sign) | See pages 109-110 |
| B Height (max) | |
| Pedestrian Street | 5 feet |
| Transitional Street | 10 feet |
| Gateway Street | 15 feet |
| C Depth (max) | 18 inches |

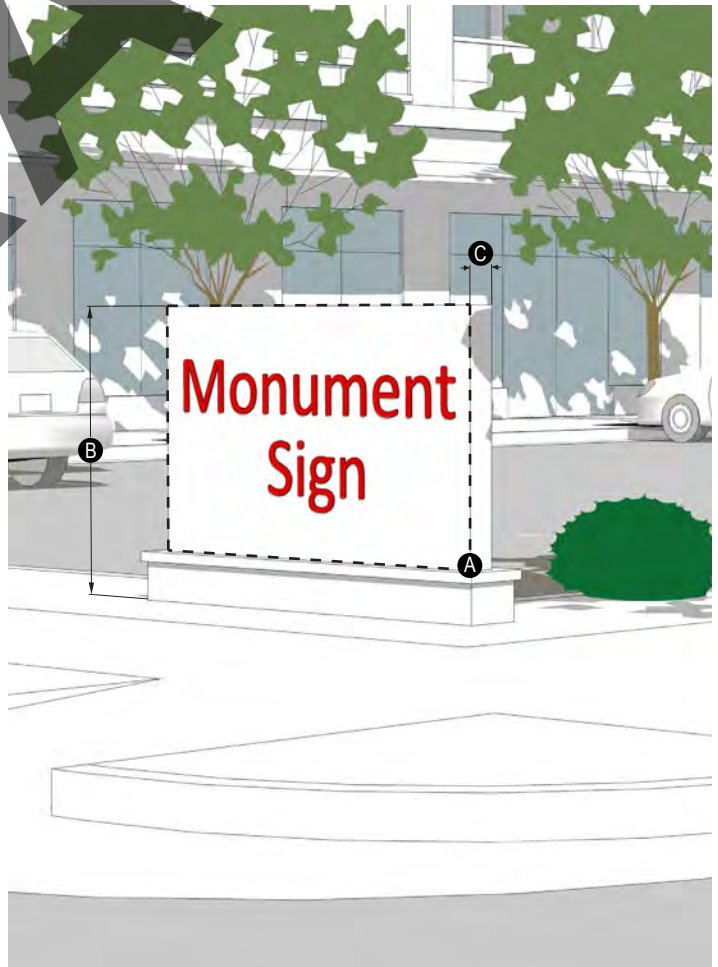

Section V: Sign Standards

Skyline Sign

Description

A building sign is attached flat to or mounted away from the building facade. Sign may be parallel to the building facade or vertical. Located on the upper band of a building.

General Standards

- A skyline sign is only allowed on buildings greater than 75 feet in height.
- A skyline sign must be located within the top third of the building.
- No portion of a skyline sign may extend above the roof line or above a parapet wall of a building with a flat roof.
- No more than one skyline sign per facade is allowed. However, additional skyline signs may be allowed as a Modification for Exceptional Design. See additional information on page 104.
- Raceways are not permitted on skyline signs.
- A skyline sign can be internally (but not externally) illuminated in accordance with page 118.
- Skyline signs may be placed on non street-facing facades through the minor modification process.

Design Standards

- | | |
|----------------------------------|-------------------|
| Ⓐ Area (max) | See pages 109-110 |
| Ⓑ Height (max) | 14 feet |
| Ⓒ Width (max % of facade length) | 60% |

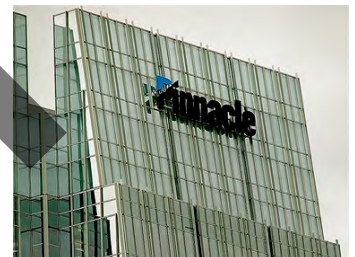

Section V: Sign Standards

Illumination

Illumination of signs shall be in accordance with the following requirements:

External Illumination

- External light sources shall be placed close to, and directed onto, the sign and shielded to minimize glare into the street, sidewalks or onto adjacent properties.
- Projecting light fixtures used for externally illuminated signs shall be simple and unobtrusive in appearance. They should not obscure the sign.

Internal Illumination

- Channel letters may be internally lit or back-lit.
- For cabinet signs, the background must be opaque. Only graphics, text and logos may be illuminated, and a halo of one inch around graphics, text, and logos may be non-opaque.
- Exposed neon may be used for lettering or as an accent.

Prohibited Light Sources

The following light sources are prohibited on every Street Type except Printers' Alley:

- Blinking, flashing, chasing, and sequential lighting.
- Bare bulb illumination.

Raceways and Transformers

- Within Redevelopment Districts, raceways may only be permitted by Modification.
- Visible transformers are prohibited.



External light sources



Internally lit channel letters



Back lit channel letters

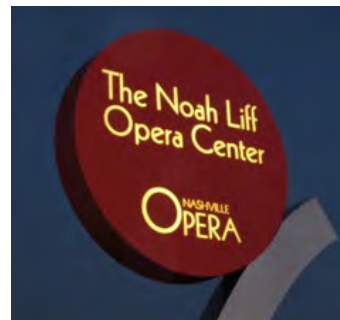

Internally lit cabinet signs with darker backgrounds

Section V: Sign Standards

Changeable Copy Signs (Manual or Electronic)

Changeable copy signs shall be in accordance with the following requirements:

Description

- Manual changeable copy sign. A sign or portion of a sign that has a readerboard for the display of text information in which each alphanumeric character, graphic or symbol is defined by objects, not consisting of an illumination device. Changeable copy is changed or re-arranged manually or mechanically without altering the face or the surface of the sign.
- Electronic changeable copy sign. A sign or portion of a sign that displays information in which each alphanumeric character, graphic, or symbol is defined by a small number of matrix elements using different combinations of light emitting diodes (LED's), fiber optics, light bulbs or other illumination devices within the sign.

Usage

- Manual changeable copy is allowed in conjunction with a wall sign, pylon sign or monument sign.
- Electronic Changeable copy is allowed in conjunction with a wall sign or a monument sign provided the changeable copy portion is no greater than 50% of the built sign area.
- An electronic changeable copy sign is not allowed in a Redevelopment District or on Interstate frontage.
- Tourist-oriented businesses within Downtown Nashville may receive Modifications to allow greater sign area and use of digital technology in accordance to the process on page 104.

Spacing

- The closest edge of an electronic changeable copy sign must be a minimum distance of 100 feet from any residential zoning district or historic district boundary.
- An electronic changeable copy sign must be separated from another electronic changeable copy sign by at least 50 feet.

Duration

- Any image or message or portion of the image or message must have a static display for minimum duration of eight seconds.
- Transition time must be immediate.
- No portion of the image or message may flash, scroll, swirl, change color or in any manner imitate movement.

Brightness

- The sign must not exceed a maximum illumination of 7,500 nits during daylight hours and a maximum illumination of 750 nits between dusk to dawn as measured from the sign's face at maximum brightness.
- Electronic changeable copy signs must have an automatic dimmer control to produce a distinct illumination change from a higher illumination level to a lower level.