

GERMANTOWN

HISTORIC PRESERVATION DESIGN GUIDELINES

GERMANTOWN HISTORIC PRESERVATION ZONING

INSIDE



<i>Introduction</i>	2
<i>Map of Overlay</i>	11
<i>Alterations & Repairs</i>	12
<i>New Construction</i>	24
<i>Outbuildings</i>	58
<i>Additions</i>	61
<i>Signage</i>	66
<i>Demolition</i>	74
<i>Relocation</i>	75
<i>Definitions</i>	76

METROPOLITAN HISTORIC ZONING COMMISSION

Metropolitan Government of
Nashville and Davidson County

Sunnyside in Sevier Park
1113 Kirkwood Avenue
Nashville, Tennessee 37204
615-862-7970
www.nashville.gov/mhc
historicalcommission@nashville.gov

Adopted: 2008
Amended: September 21, 2017
Italicized information revised 2024

I. INTRODUCTION

A THE HISTORIC PRESERVATION ZONING OVERLAY

Please also see *MHZC Hand Book* at www.nashville.gov/Historical-Commission/Services/Preservation-Permits/Districts-and-Design-Guidelines.aspx

Neighborhoods in more than two thousand towns in the United States use historic zoning as a tool to protect their unique architectural characters. There are quantifiable reasons for historic zoning: it gives neighborhoods greater control over development; it can stabilize property values; it decreases the risk of investing in one's house; it promotes heritage tourism; it protects viable urban housing stock; it preserves natural resources by conserving building materials. There are less quantifiable, but equally important, reasons for conservation zoning -- it protects our past for future generations, it nurtures a sense of community, and it provides a sense of place.

Historic zoning overlays are **locally** designated and administered by the Metropolitan Historic Zoning Commission (MHZC), an agency of the Metropolitan Government of Nashville and Davidson County. Historic zoning overlays are applied in addition to the base or land-use zoning of an area. *Historic zoning overlays do not regulate use but rather focus on architectural design.*

Like the National Register of Historic Places, historic preservation zoning honors an area's historical significance. With that recognition, certain exterior work on buildings—new construction, additions, demolition, and relocation—is reviewed to ensure that the neighborhood's special character is preserved.

There are four types of historic zoning overlays: historic preservation, neighborhood conservation, historic landmarks and Bed & Breakfast Homestays. In addition to the projects reviewed in a neighborhood conservation zoning overlay, historic preservation and historic landmark overlays also review exterior alterations to existing buildings -- like replacing siding or installing a fence. Overlays with historic preservation or historic landmark zoning are not more historically significant than those with neighborhood conservation zoning; rather, the MHZC with neighborhood input and direction of the Council member, determined that this overlay is most compatible with the goals of the neighborhood and the MHZC.

WHAT IS REVIEWED:

IN A HISTORIC LANDMARK OVERLAY

- *New construction (primary and secondary structures)*
- *Additions – increased footprint, height or building envelope of an existing structure*
- *Demolition (in whole or in part)*
- *Relocation of structures*
- *Construction of appurtenances (with the exception of portable storage buildings less than 100 square feet)*
- *Signage*
- *Repairs and Alterations to existing structures*
- *Setback Determinations*

IN A HISTORIC PRESERVATION OVERLAY

- *New construction (primary and secondary structures)*
- *Additions – increased footprint, height or building envelope of an existing structure*
- *Demolition (full or in part)*
- *Relocation of structures*
- *Construction of appurtenances (with the exception of portable storage buildings less than 100 square feet)*
- *Signage*
- *Repairs and Alterations to existing structures*
- *Setback Determinations*



I. INTRODUCTION

B. WHAT ARE THE DESIGN GUIDELINES?

The Metropolitan Historic Zoning Commission (MHZC) is the architectural review board that reviews applications for work on properties within historic zoning overlay districts. Its nine members, appointed by the mayor, include representatives from zoning districts, the Metropolitan Planning Commission, the Metropolitan Historical Commission, architect(s) and others. Design review is administered according to a set of design guidelines. The guidelines are criteria and standards, developed jointly by the MHZC and the residents of the neighborhood, which are used to determine the architectural compatibility of proposed projects. The guidelines provide direction for project applicants and ensure that the decisions of the MHZC are not arbitrary or based on anyone's personal taste.

The guidelines protect the neighborhood from new construction or additions that are not in character with the neighborhood and from the loss of architecturally or historically important buildings.

By state and local legislation, design guidelines for historic overlays must be in accordance with the [*Secretary of the Interior's Standards for the Treatment of Historic Properties*](#)—criteria developed by the National Park Service and used by private and public preservation organizations throughout the country. (Please see I.D.)

IN A NEIGHBORHOOD
CONSERVATION OVERLAY
(NCZO)
(also B&B Homestays)

- *New construction (primary and secondary structures)*
- *Additions – increased footprint, height or building envelope of an existing structure*
- *Demolition (in whole or in part)*
- *Relocation of structures*
- *Setback Determinations*

WHAT IS NOT REVIEWED
IN HISTORIC
PRESERVATION
OVERLAYS

- *Temporary (30 days or fewer) appurtenances, such as:*
 - Real estate, opening soon, special event, and construction signage*
 - Construction related fencing and structures*
 - Special event related structures*
- *Painting of wood*

I. INTRODUCTION

C. PURPOSE OF THE DESIGN GUIDELINES

Within the zoning ordinance, “historic zoning” is used as the general term for Nashville’s three types of zoning overlay districts applicable to historic properties: historic preservation, neighborhood conservation, and historic landmark. The references to historic zoning in the ordinance and design guidelines are to be understood as neighborhood conservation zoning overlay, or simply conservation zoning.

Design guidelines are criteria and standards which the Metropolitan Historic Zoning Commission must consider to determine the appropriateness of proposed work within a neighborhood conservation zoning district. Appropriateness of work must be determined in order to accomplish the goals of historic and neighborhood conservation zoning, as outlined in Article IX (Historic Zoning Regulations), Metropolitan Comprehensive Zoning Ordinance:

- a. To preserve and protect the historical and/or architectural value of buildings or other structures;
- b. To regulate exterior design, arrangement, texture, and materials proposed to be used within the historic district to ensure compatibility;
- c. To create an aesthetic appearance which complements the historic buildings or other structures;
- d. To foster civic beauty;
- e. To strengthen the local economy; and
- f. To promote the use of historic districts for the education, pleasure, and welfare of the present and future citizens of Nashville and Davidson County.

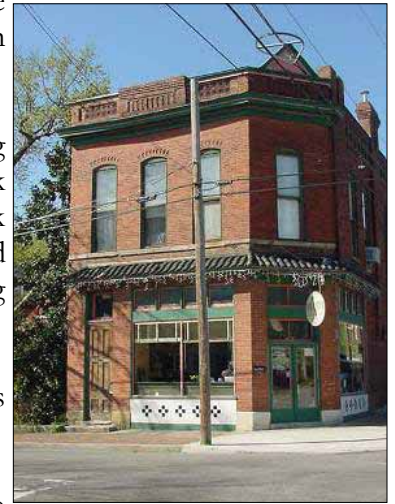

The Neuhoff store has been renovated and operated as a restaurant since the 1980s.

I. INTRODUCTION

D. SECRETARY OF INTERIOR'S STANDARDS FOR REHAB

By state law, all design guidelines for neighborhood conservation zoning overlays must comply with the Secretary of the Interior's Standards for Rehabilitation:

1. A property shall be used for its historic purpose or be placed in a new use that requires minimal changes to the defining characteristics of the building and its site and environment.
2. The historic character of a property shall be retained and preserved. The removal of historic materials or alteration of features and spaces that characterize a property shall be avoided.
3. Each property shall be recognized as a physical record of its time, place, and use. Changes that create a false sense of historical development, such as adding conjectural features or architectural elements from other buildings, shall not be undertaken.
4. Most properties change over time; those changes that have acquired historical significance in their own right shall be retained and preserved.
5. Distinctive features, finishes, and construction techniques or examples of craftsmanship that characterize a property shall be preserved.
6. Deteriorated historic features shall be repaired rather than replaced. Where the severity of deterioration requires replacement of a distinctive feature, the new feature shall match the old in design, color, texture, and other visual qualities and, where possible, materials. Replacement of missing features shall be substantiated by documentary, physical, or pictorial evidence.
7. Chemical or physical treatments, such as sandblasting, that cause damage to historic materials shall not be used. The surface cleaning of structures, if appropriate, shall be undertaken using the gentlest means necessary.
8. Significant archeological resources affected by a project shall be protected and preserved. If such resources must be disturbed, mitigation measures shall be undertaken.
9. New additions, exterior alterations, or related new construction shall not destroy historic materials that characterize the property. The new work shall be differentiated from the old and shall be compatible with the massing, size, scale, and architectural features to protect the historic integrity of the property and its environment.
10. New additions and adjacent or related new construction shall be undertaken in such a manner that if removed in the future. The essential form and integrity of the historic property and its environment would be unimpaired.

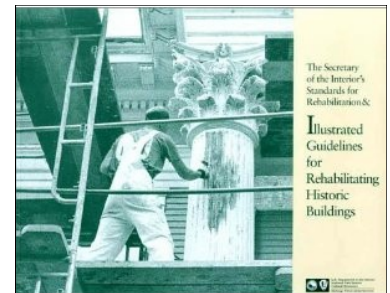

The full set of Secretary of Interior Standards may be found online at www.nps.gov/tps/standards/rehabilitation/rehabilitation-guidelines.pdf.

I. INTRODUCTION

E. A SHORT HISTORY OF THE OVERLAY AND THE NEIGHBORHOOD

Germantown, like neighborhoods in more than two thousand other cities and towns in the United States, uses historic zoning as a tool to protect and preserve its historic and architectural heritage. This tool is also used to guide new development within the boundary of an historic district where there is little or no remaining historic context. There are quantifiable reasons for historic zoning. It:

- stabilize property values
- give residents greater control over development in their neighborhood
- promote heritage tourism
- provide affordable housing, and
- preserve natural resources by conserving building materials.

In addition, there are less quantifiable but equally important reasons for historic zoning in that it:

- protects our past for future generations,
- nurtures a sense of community, and
- contributes to a sense of place.

Present-day Germantown exhibits both 19th century and new design and development patterns. The Germantown Historic Zoning District is intended to provide protection for the unique qualities of existing historically significant structures and offer guidance for further development in Germantown.

For much of the later part of the 20th century, Nashville residents were largely unaware that an area north of Jefferson Street was once a prominent neighborhood where many of Nashville’s leading citizens lived. This German community began flourishing in the 1840s by blending its German heritage with Irish, Italian, Swiss and Jewish neighbors, in public schools and sometimes in churches. The Catholic Church of the Assumption, founded in 1859, held many of its services in German as did the German Methodist Church (Barth Memorial, founded in 1854) on North Cherry Street (Fourth Ave. North).

Many prosperous merchants in Germantown and prominent retail names hung on store signs downtown including Buddeke, Ratterman, Thuss, Grossholtz, Jeck, Wheling and Zickler. Residents walked downtown or



View of Germantown looking south towards Capitol Hill and the Assumption Church (c. 1860).



The 1200 block of Fifth Avenue North looking towards Monroe Street (c. 1950).

I. INTRODUCTION

rode in the horse-drawn trolleys between Public Square and Jefferson Street.

In the 1870s, a second influx of immigrants was attracted to the area by the substantial German population already there. With this influx, North Nashville became the focus of German immigration in Tennessee; and its leaders influenced the architecture, politics, and history of the city and state.

In this German community, many immigrants worked as butchers, a practice brought over from Europe. They often used sheds in their backyards as slaughter houses and sold their meat first to individuals and then to local markets or to the Nashville Market House. Many opened their own markets or stalls. Names such as Jacobs, Dieterle, Steir, Warner, Oliver, Newhoff, Petre, Laitenberger and White were among those from North Nashville. Meat suppliers from “Butchertown” developed the Christmas spiced round, a famous Nashville holiday meat.

By 1915, changes took place that would eventually bring about the neighborhood’s decline. As streetcar lines expanded and advancements were made in motor transportation, there was a trend for residents to move away from “walk-to-town” areas. Moreover, the development of refrigeration led to the phasing out of many small butchering businesses. Larger slaughter and meat packing houses developed and were concentrated along the west bank of the Cumberland River. They infringed upon the pleasant residential atmosphere of the neighborhood that had often been advertised in local newspapers as a growing and fashionable community.

However, it was World War I that dealt the final blow to Germantown as a healthy, inner-city neighborhood. Newspapers were filled with stories of German atrocities, such as the use of poisonous gases and deliberate infection of water supplies. Rising anti-German sentiment encouraged many German families to stop speaking German – even at home and saw the German residents moving out of the area and dispersing around the city. The German Methodist Barth Memorial Church illustrates what happened in Germantown. For many years services were completely in German, but after the start of the war a shift was made to English. The Catholics and Lutherans with German backgrounds did likewise. The uniqueness of a small community with ties to the “Fatherland” was over. The neighborhood as it once was would never return, and constant decline



View of Germantown from Capitol Hill looking over the old Farmer’s Market along Jefferson Street.



View from Germantown towards Capitol Hill and the Bicentennial Mall.



One of Germantown’s oldest residences (c. 1840) on Fifth Avenue North during a renovation.

I. INTRODUCTION

ensued until the late 1970s when a handful of urban pioneers decided to attempt to create a new Germantown.

During the decades of decline, many houses became rental property, with larger homes becoming rooming houses. In the 1950s, industrial zoning was put in place over the old neighborhood. Houses began to be torn down or extensively altered, their repair and maintenance deterred by depressed property values and increased absentee ownership resulting from the industrial zoning.

Industrial and commercial buildings and vacant land replaced the 19th and early 20th century buildings. Nonetheless, studies made by the Metropolitan Historical Commission in the 1970s stated that: “A larger percentage of structures are still intact and it can become a viable neighborhood. The quality of the architecture is exceptional, and the condition of the structures is, for the most part, quite sound.”

The same studies found that the Germantown Historic District was one of the most architecturally heterogeneous neighborhoods in the city. The eight-block area contain a wide variety of styles and types of residences built between the 1840s and 1920s. In recognition of its historical and architectural significance, the MHC nominated to the National Register of Historic Places and it was listed in August of 1979.

Steps to revitalize the neighborhood and establish its new identity began in earnest in 1980. Members of two historic churches, the Catholic Church of the Assumption and the Monroe Street United Methodist Church, gave Nashville its first Oktoberfest, a homecoming event that has helped to reestablish the neighborhood’s identity. This event has since become one of Middle Tennessee’s most popular celebrations.

Around the same time the Historic Germantown Neighborhood Association (HGN) was established. Through this forum, residents and property owners explored methods for reversing the neighborhood’s decline. The existing industrial base zoning was generally not appropriate for the neighborhood to be revitalized because the mix of residents, businesses, and other uses could not successfully fit into any existing zoning

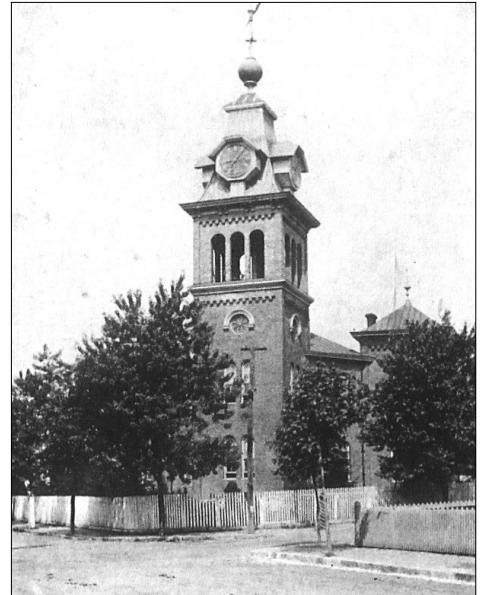

Above: The original Elliott School building at Jefferson and Sixth Avenue North. Below: The Elliott School in 2005.



Infill at Fifth Avenue North and Madison Street

I. INTRODUCTION

categories. The neighborhood worked with the Metro Planning Commission to develop a “mixed-use” zoning category. This designation has become a popular planning tool beyond the boundaries of Germantown.

Residents began to acquire vacant land parcels as they became available, basically “land-banking” them for the future. The neighborhood received a Community Development Block Grant (CDBG) that was converted into a revolving fund. Through this fund, several renovation projects were completed. The fund was also used to acquire several vacant historic houses, reselling them with preservation easements and to purchase vacant parcels.

A major turning point for the neighborhood was the threat of an entire half block being developed as an auto-emission test site. Strong neighborhood protests saw this property being acquired by Metro (using the accumulated revolving fund) and being dedicated for future residential infill development. The Metro Development and Housing Authority worked with the neighborhood to develop an RFP for the successful solicitation of proposals from developers for new residential infill. This resulted in the construction of 18 new single and duplex residences as well as a mixed use residential (condo) and commercial building on this site.

Through the early 1990s, other activities spurred the revitalization of the area. The replacement of the 1911-era Jefferson Street Bridge led to improvements along Jefferson Street from Second Ave. North to Eighth Ave. North. The state of Tennessee celebrated its bicentennial by developing the Bicentennial Mall State Park in 1996 to preserve and enhance the view of the State Capitol. As part of the Bicentennial Mall project, the old Farmers Market was closed and new facilities built. The warehouse grocery store was demolished and MDHA recruited a new Kroger supermarket on Rosa Parks Blvd. to serve Germantown and the surrounding neighborhoods.

In 1993 MDHA created the Phillips-Jackson Redevelopment District, which included most of the Germantown area. As a component of this plan, MDHA was able to incorporate design guidelines for the Germantown



Infill on the 1300 block of Seventh Avenue North.



Infill on the 1400 block of Fifth Avenue North



Infill at Sixth Avenue North and Madison Street.

I. INTRODUCTION

National Register district. By 2006 the neighborhood was facing considerable redevelopment interest and decided to seek an historic zoning overlay that would be administered by the Metro Historic Zoning Commission. A task force of residents, business owners and developers worked together to craft design guidelines for the new historic zoning overlay, which were completed and passed by the Metro Council in 2007.

Germantown, located within a few steps of the Bicentennial Mall State Park and less than six blocks from the State Capitol and downtown, has undergone continual revitalization since the early 1980s. The neighborhood has again become a diverse and innovative urban community blending historic buildings with new urban infill design and sustainable building practices. Germantown's redevelopment guided the diligence and cooperation of longtime and new neighbors, has contributed to the growth and revitalization of adjacent neighborhoods and the larger Nashville urban core.

A ride or walk through the neighborhood today reveals a new revitalized community of restored houses, new infill construction, multi-family developments, restaurants, businesses and shops, and attractive brick sidewalks. Through the leadership of its active neighborhood association and shaped by the Historic Zoning Overlay District guidelines, Germantown's urban past has been reclaimed and its future potential, as a model urban neighborhood, will be exciting to watch.

Contributory Status: *Buildings constructed during the period of significance for the district and that have physical integrity are considered as "contributing" to the historic character of the district. They may or may not be significant individually but instead, significant as part of a collection. Buildings that do not contribute to the historic character of the district are called non-contributing. Contributory status and period of significance can change over time as new information becomes available and as districts age. The first factor to consider is the building's age. Was the building constructed during the period of significance of the district? Is that period of significance still valid? The second consideration is an analysis of the changes that have taken place over time. Does the building retain the majority of its character defining features and form? If the building retains its original form, despite numerous changes, it is likely still considered contributing.*

I. INTRODUCTION

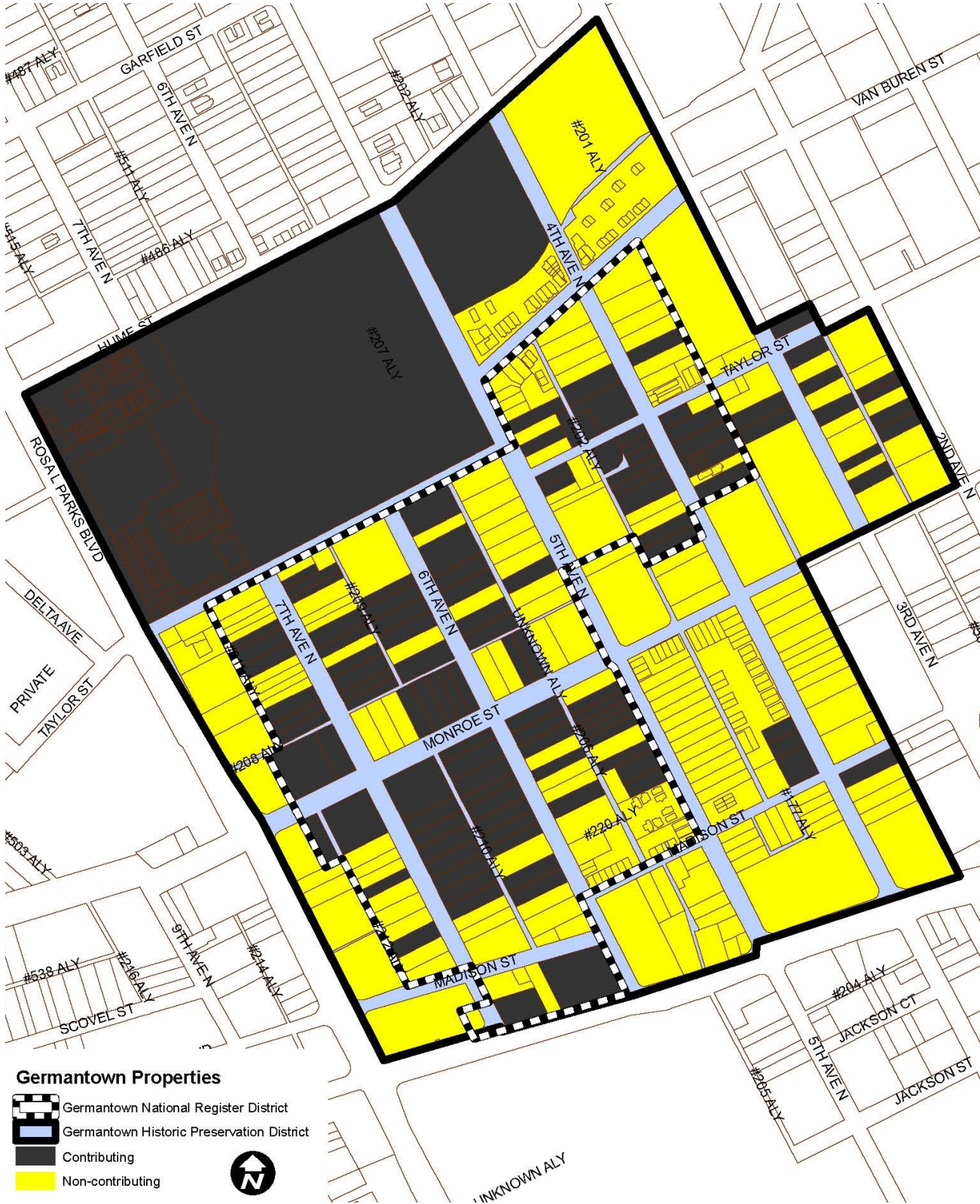

II. REPAIRS, REPLACEMENT & ALTERATIONS

Italicized sections of the guidelines contain interpretive information clarifies the guidelines and memorializes past decisions of the MHZC. They are not part of the guidelines themselves. Illustrations are intended only to provide example buildings and circumstances. It is important to remember that every building is different and what may be appropriate for one building or site may not be appropriate for another.

A. GENERAL PRINCIPLES

1. These guidelines apply only to the **exteriors** of structures. Any interior alterations that require exterior alterations or change the look of the exterior such as changing floor lines or removing load bearing walls should not be undertaken. Care should be taken during rehabilitation not to remove stabilizing factors such as plaster lathe and original siding.
2. Exterior repairs, replacement and alterations to be done on public facades shall be more carefully reviewed than that done on non-public facades. Public facades are those that are visible from the public right-of-way, street, alleys or greenways. Non-public facades are those not visible from the public right-of-way, street, alleys or greenways.
4. The color of paint used on wood surfaces is not reviewed. The inherent color of materials, such as masonry and metal, is reviewed.
5. Alterations and repairs to non-contributing (non-historic) buildings should be appropriate for the historic context. Alterations and repairs to contributing (historic) buildings should be appropriate for the individual historic building.



Transitional Victorian



Queen Anne Cottage



Craftsman

B. REPAIR, REPLACEMENT & ALTERATIONS GUIDELINES

1. Materials & Features

- a. All original materials and features shall be repaired. Replacement may be appropriate when the existing material or feature no longer exists or is beyond repair. Alterations may be appropriate on secondary facades, when original conditions no longer exist, or when there is no evidence of original



Italianate

II. REPAIRS, REPLACEMENT & ALTERATIONS

conditions. Also see “Materials and Features-Additional Guidance.”

b. Repair

- The distinguishing qualities or character of a building, structure, or site and its environment should not be destroyed. Removal or alteration of any historic material or distinctive architectural features should be avoided.
- Original dimensions, form, pattern, color and texture of historic materials and features and locations of features should be retained and preserved.
- Original materials and features shall not be covered with new materials.
- Deteriorated architectural features should be repaired rather than replaced whenever possible. In the event replacement is necessary, see “replacement” below.
- Surface cleaning of structures should be undertaken with the gentlest means possible. Sandblasting, high-pressure water cleaning and other highly abrasive cleaning methods that damage historic building materials should not be used.

c. Replacement

- When original materials or features no longer exist or are beyond repair, replacement may be appropriate. New material should be the same as the original material. In cases where the original material is not readily available or unreasonable to use, substitute materials shall match the original in composition, design, texture, other visual qualities and workability.
- Replacement of missing architectural features should be based on historic, physical, or pictorial evidence.

d. Alterations

- Renovations shall be consistent with the existing building in terms of height, scale, setback, and rhythm; relationship of materials, texture and color; roof shape; orientation; and proportion and rhythm of openings

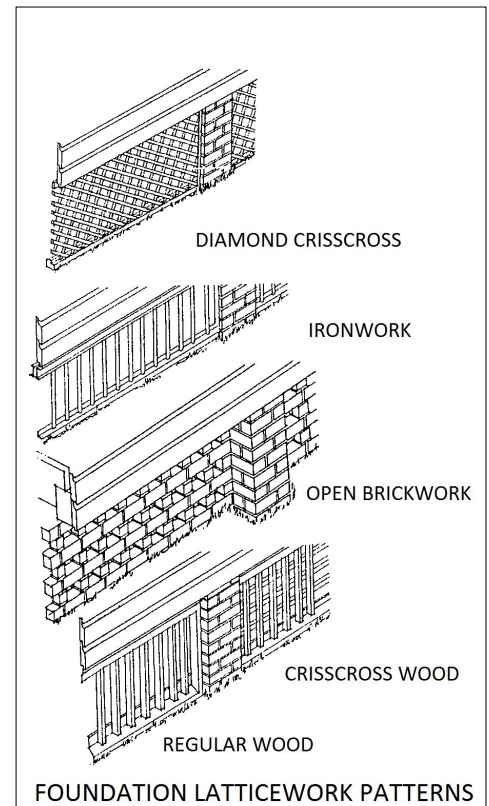

Appropriate foundation treatments above include diamond crisscross wood lattice, iron lattice, open brick lattice, and wood lattice, both vertical and crisscross

II. REPAIRS, REPLACEMENT & ALTERATIONS

- Changes that may have taken place over the course of time are evidence of the history and development of a building, structure, or site and its environment. These changes may have acquired significance in their own right, and this significance should be recognized and respected. Conversely, removal of inappropriate additions is encouraged.
- Conjectural features should not be added to buildings unless there is physical or photographic evidence to show that the detailing was original to the building.
- Alterations that remove cover historic features should not be undertaken.

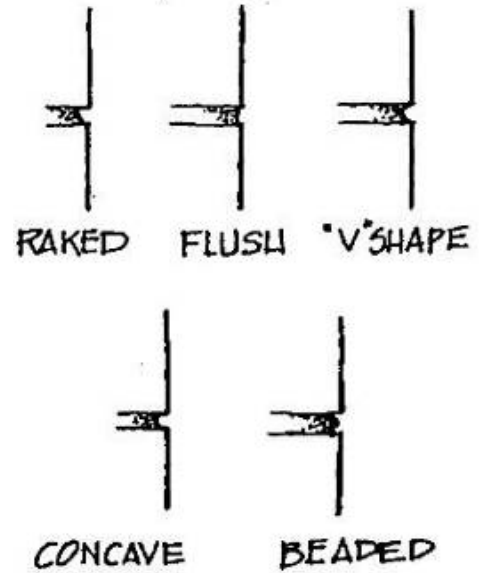

Typical mortar joints.

C. ADDITIONAL GUIDANCE BY MATERIALS AND FEATURES

1. Masonry

- Painting masonry, whether for a sign or mural, is generally not appropriate. Painting or staining brick may be appropriate if: brick has previously been painted; or if brick has been sandblasted or otherwise

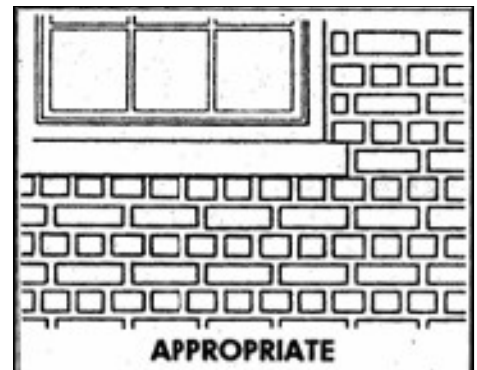
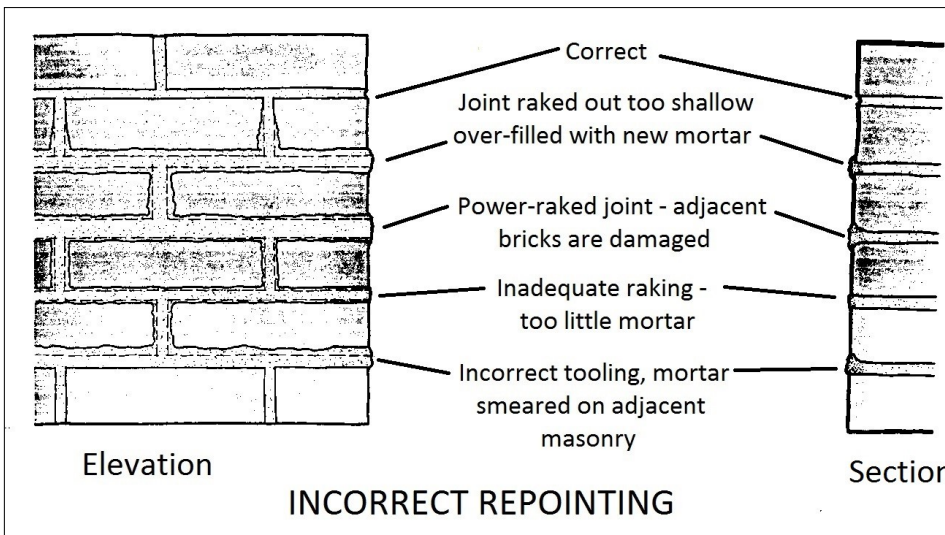

Deteriorated brick should be repaired duplicating bond, brick size, color and width of joint.

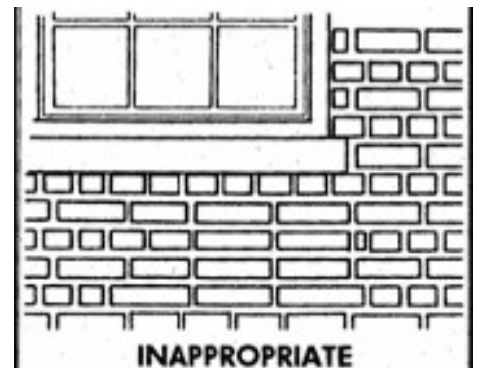

Mortar joint deterioration and repair.

II. REPAIRS, REPLACEMENT & ALTERATIONS

damaged and is too deteriorated to withstand weather. In this case, a brick-color, water-based stain approximating the original color of the building’s brick should be used. If the original color is unknown, a historic brick color from a building of similar style and era may be used.

- b. Murals (painted art) and decals are not appropriate on historic or commercial buildings. See “signage” for painted signs.
- c. Re-pointing should be done with care to match the original mortar color and joint profile.
- d. Portland cement can damage historic brick and should not be used. Soft, lime based mortars are more appropriate for use with historic brick. Original tooling configuration and joint width and depth should be maintained. Extreme care should be taken when cutting out joints for repointing.
- e. Silicone-based water sealants are not recommended on historic masonry as it may cause damage to the brick-face over time. Building owners are encouraged to remove paint from masonry. Gentle, non- abrasive

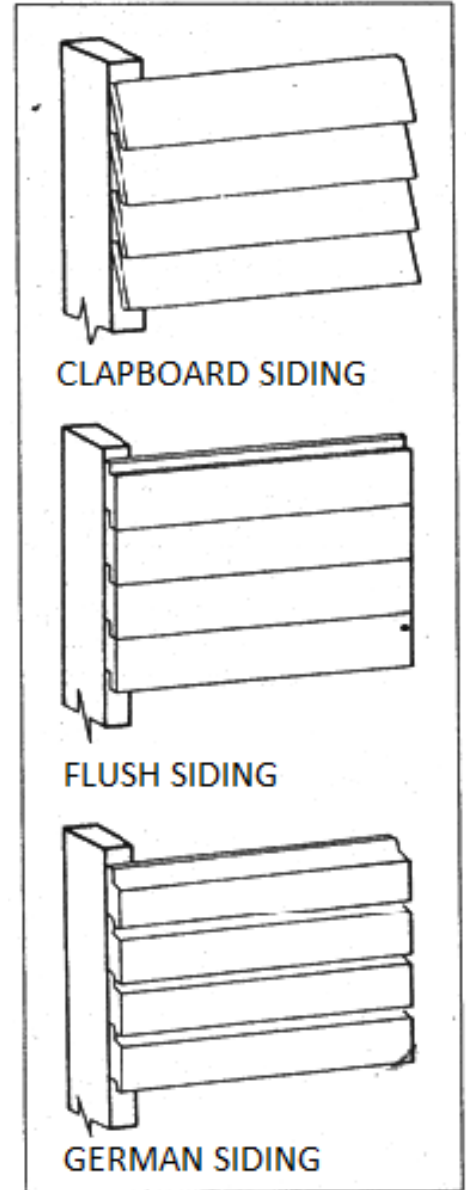

CLAPBOARD SIDING

FLUSH SIDING

GERMAN SIDING

Examples above show typical siding styles.

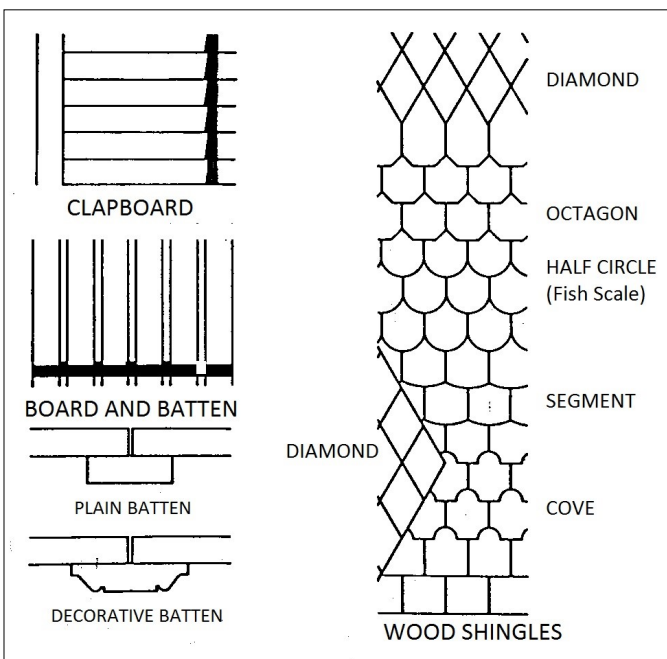

Types of wood siding.

II. REPAIRS, REPLACEMENT &

chemical cleaning is an appropriate method to remove paint. Detergent cleaners and chemical stain and paint removers to clean masonry or remove paint is appropriate under most conditions. Abrasive or high-pressure cleaning methods are destructive and should not be used.

2. Wood

- a. Replacement wood siding, when necessary, should be consistent with the original in terms of size, profile, lap direction, and lap exposure. Typical material lap is between 3” and 5”.

3. Doors & Windows

- a. Door and window openings on the front half of a building or those visible from a public right-of-way should not be filled in. New window and door openings, not original to the building should not be introduced to the front half of the building or elevations visible from a public right-of-way.
- b. Full glass storm doors are permitted where their dimensions match existing door dimensions to conceal their presence, frames should be set within the existing door frame. Unpainted aluminum storm doors are not appropriate.
- c. Storm windows are permitted where their dimensions match window dimensions. To conceal their presence, frames should be set within the window opening (blind-stop) and attach to the exterior sash stop. Unpainted aluminum storm sash, screens, and windows are not appropriate.
- d. Exterior security doors may be appropriate on rear facades.
- e. If original windows no longer exist and there is no pictorial evidence of the original design, replacements should be appropriate for the



Typical door types in Historic Germantown.



Examples of historic windows in Germantown, all of which, including paired windows, are very tall and vertical in their proportions.

II. REPAIRS, REPLACEMENT & ALTERATIONS

- building's style and period or may be 1/1 double-hung wood sashes.
- f. Replaced glazing or the glazing for new windows and doors should be 100% clear.
- g. Snap, clip, glue, or interior type muntins or between-the-glass blinds on windows are not permitted.
- h. Shutters, where pictorial or other convincing historical evidence support their previous existence, should be appropriate to the building



Inappropriate windows alterations.

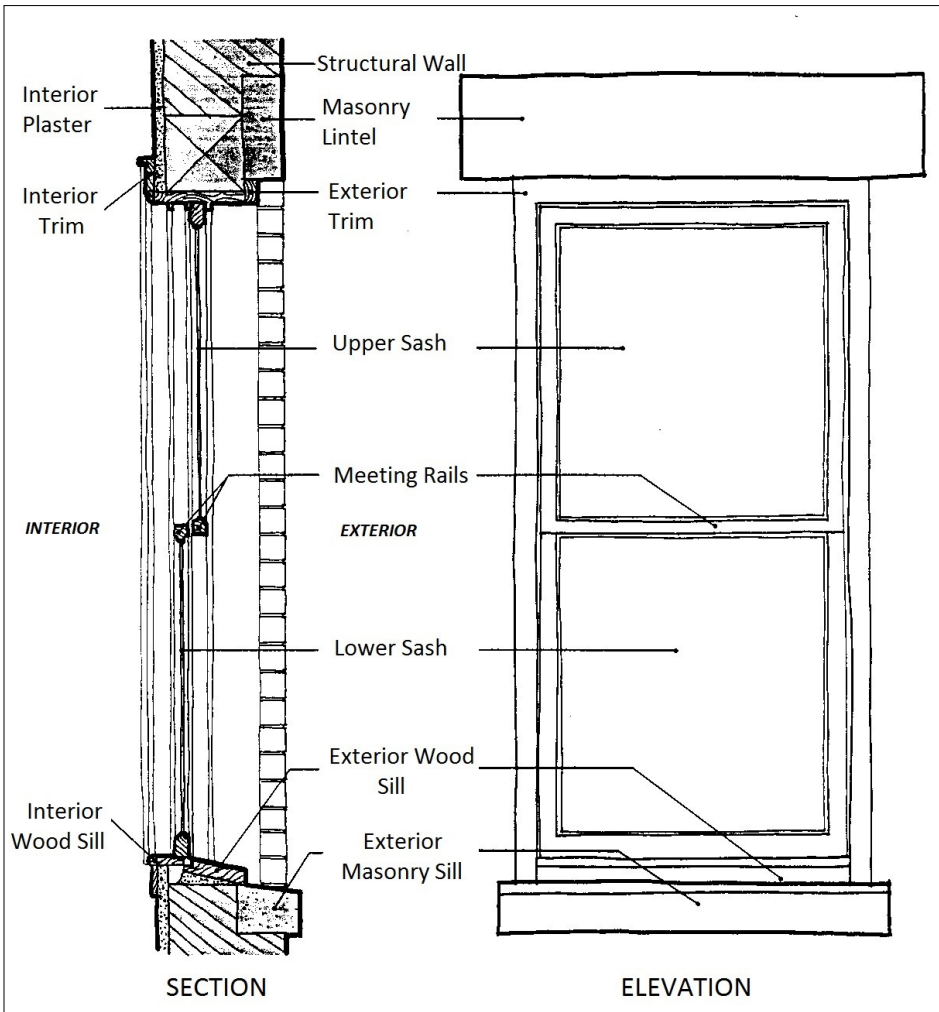

Parts of a window.



Examples of elaborate window lintels including wood (top), stone (center), and sheet metal (below).

II. REPAIRS, REPLACEMENT & ALTERATIONS

style, be operable, and fit the opening with respect to height and width so that, if closed, the entire opening would be covered.

- i. Window grilles and balcony rails are not appropriate window treatments.

4. Porches & Balconies

- a. Enclosing front porches is not permitted.
- b. Enclosing side porches may be appropriate where the visual openness and character of the porch are maintained.
- c. Balconies should not be added to public facades unless historical documentation can be provided.



*Above: Historic porch.
Below: Inappropriate alteration.*

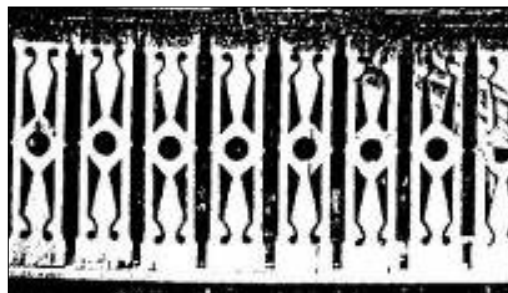

Examples of scroll and saw and turned baluster railing treatments.

II. REPAIRS, REPLACEMENT & ALTERATIONS



APPROPRIATE

Front porches like the one above should be kept open. To the left is an example of an appropriate enclosure of a side or rear porch that maintains the appearance of a porch.



Examples of front porch designs.



Examples of remarkable diversity of front porch and roof detailing.



II. REPAIRS, REPLACEMENT & ALTERATIONS

5. Roofs

- a. Appropriate roofing materials include metal, slate, and asphalt/fiberglass shingles.
- b. Extant historic metal roofing should be replaced with a new metal roofing similar in design and dimension.
- c. Installation of gutters and downspouts should not result in the removal or obstruction of historic building elements. Gutters and downspouts should be located on non-public facades of buildings where possible.
- d. Skylights should not be located on the front-facing slope of a roof. Skylights should be flat (no bubble lenses) with a low profile (no more than six inches tall) and only be installed beyond the midpoint of the building).

II. REPAIRS, REPLACEMENT & ALTERATIONS



Examples of the diversity of detail at the roofline of houses in Germantown.



Examples of historic attic ventilation grilles.

II. REPAIRS, REPLACEMENT & ALTERATIONS

6. Commercial Storefronts

- a. If replacement storefronts or component elements are necessary, replacements should be compatible with the original materials, composition, design, textures, and general appearance.
- b. When replacement of storefront windows is appropriate, appropriate replacement elements include individual or grouped single-light clear-glass panes and simple wood, copper, bronze anodized aluminum, or baked-enamel aluminum frames.
- b. When replacement transoms are appropriate, appropriate elements include single or multi-light clear-glass and simple wooden or metal frames.
- c. When replacement of bulkheads is appropriate, appropriate replacement elements include paneled and painted wood, brick, and metal.
- d. Rear elevations are service-oriented and are appropriate locations for infrastructure elements such as mechanical systems, utility meters and connections, and fire stairs.

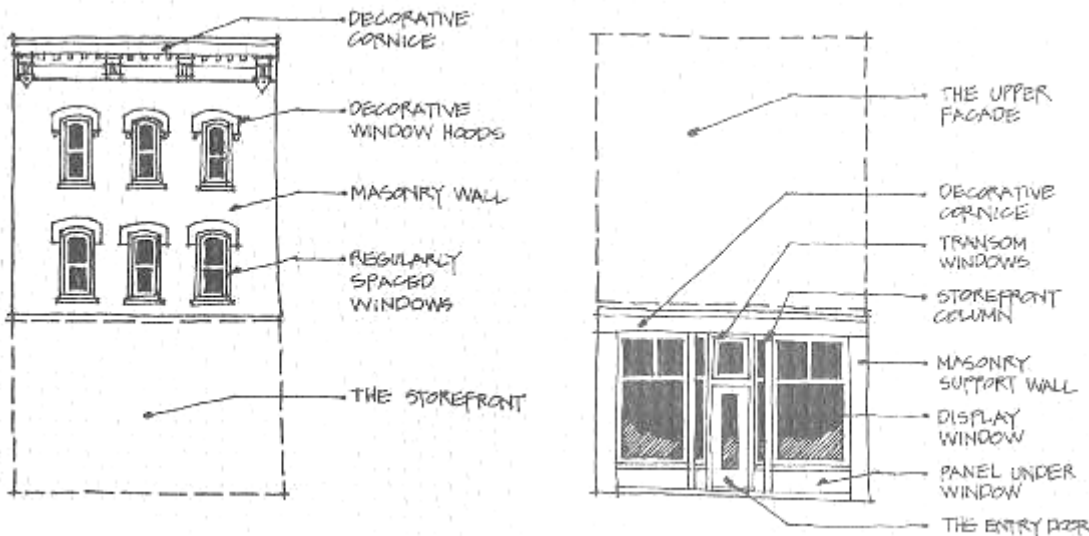

Component parts of storefronts.

II. REPAIRS, REPLACEMENT & ALTERATIONS

TYPICAL STOREFRONTS

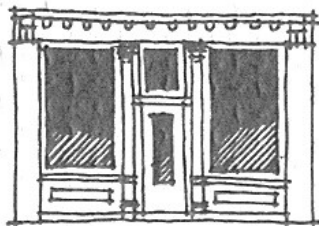

Mid 1800s to early 1900s

- BOLDLY DECORATED CORNICE.
- CAST IRON COLUMNS.
- LARGE DISPLAY WINDOWS.

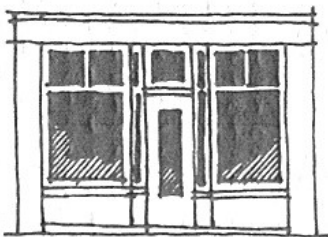

Early 1900s to 1930s

- SIMPLIFIED CORNICE.
- TRANSOM WINDOWS OVER DISPLAY WINDOWS.
- METAL WINDOW FRAMES.

Storefront transitions.

TYPICAL UPPER FACADES

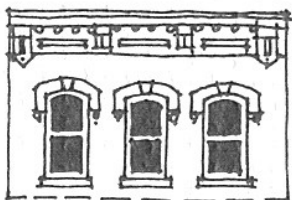

Mid to late 1800s

- BOLDLY DECORATED CORNICE AND WINDOW HOODS.
- NARROW WINDOW OPENINGS.

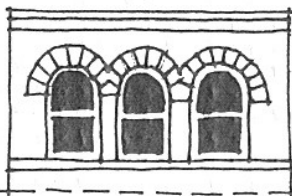

Late 1800s to early 1900s

- CORBELED BRICK CORNICE
- LARGE WINDOW OPENINGS.
- ARCHED WINDOW OPENINGS.

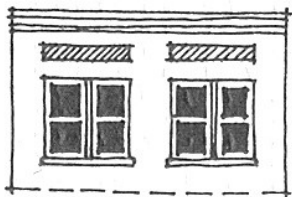

Early 1900s to 1930s

- CORBELED BRICK CORNICE
- LARGE WINDOW OPENINGS WITH MULTIPLE WINDOW UNITS.

Upper façade transitions.

III. NEW CONSTRUCTION

A. GENERAL PRINCIPLES

Germantown is an eclectic district with distinct that contain different types of development. For this reason, the district is divided into “Development Zones” for site planning and “Building Types” for building design. Each project should meet the guidelines provided for “All Development Zones” and follow the more specific guidance for the “Building Type” and the “Development Zone” in which project is located.

Each “Development Zone” identifies the “Building Types” appropriate for that zone. *The “Building Types” are very similar to those found in the Planning Department’s “Community Character Manual” but with additional information and guidance specific to Germantown.*

Process for Planning New Construction in Germantown:

1. Determine the proposed “Building Type.”
2. Determine the “Development Zone” in which the project will be located. Check to be sure that the desired “Building Type” is appropriate in that “Development Zone.” If so,
3. Follow the guidelines for the “Building Type” in designing the building, the guidelines for the “Development Zone” when designing the site and the “General Design Guidelines” for both the design of the building and the site.

B. BUILDING TYPES

The Commission only reviews the design of buildings, sites and improvements. Applicants should check with the Metro Codes Department to assure that the intended use is permitted.

1. House Building Type

A House is a low-rise detached structure suitable as a residence. It is

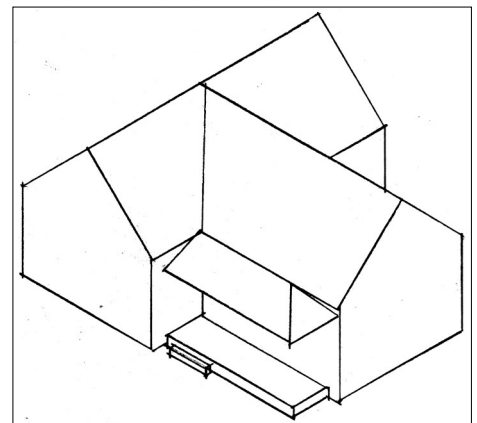

House Building Type.

III. NEW CONSTRUCTION

generally 1, 1.5 or 2 stories. Vehicular access is from the side street, or alley. The pedestrian entrance is located along the primary street frontage of the building. This building type typically has a pitched roof. Common forms in this district are side and front gables, hipped and pyramidal, hipped with gables and cross gabled forms. Mansard roof forms are atypical and generally not appropriate. When used, mansard roof forms should be minimal and be proportional to historic mansard roofs. Typical pitch ranges from 7/12 to 14/12.

- a. Patios, and decks are not appropriate for the front setbacks of this building type.

2. Plex House Building Type

A Plex-House is a single structure that contains two or more dwelling units. Each unit has its own pedestrian entry, or shares a common entry along the street frontage. Some duplexes have a corner porch on each side. Vehicular access is from the side street, or alley. Common examples of this building type include duplex, triplex, and quadplex. This building type typically has a pitched roof. Common forms in the district are side and front gables, hipped and pyramidal, hipped with gables and cross gabled forms. Mansard roof forms are atypical and general not appropriate. When used, mansard roof forms should be minimal and proportional to historic mansard roofs. Typical pitch ranges from 7/12 to 14/12.

- a. Patios, and decks are not appropriate within the front setbacks of this building type.

3. House Court Building Type

A House Court is a low-rise group of small detached houses arranged around a common courtyard, or open space. Front façades and primary pedestrian entrances are oriented to and accessed from the common area; houses on the primary street are oriented to, and accessed from, the



Historic duplex at 1315 6th Ave North

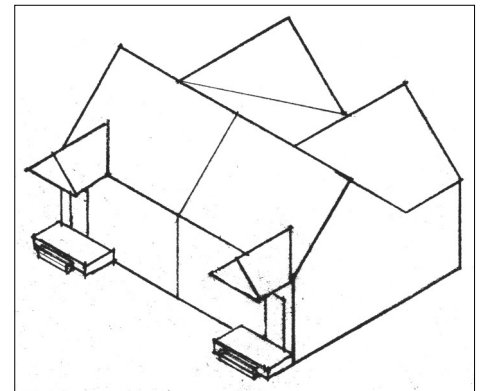

Plex House Building Type .

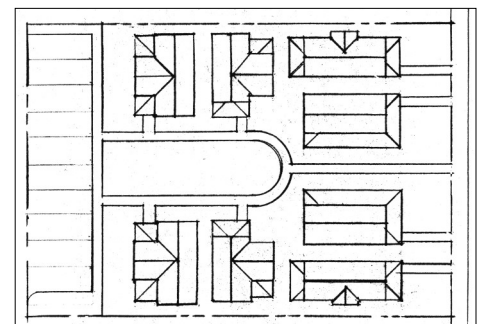

House Court Building Type



III. NEW CONSTRUCTION

primary street. Vehicular access is from the alley.

This building type typically has a pitched roof. Common forms in the district are side and front gables, hipped and pyramidal, hipped with gables and cross gabled forms. Mansard roof forms are atypical and general not appropriate. When used, mansard roof forms should be minimal and proportional to historic mansard roofs. Typical pitch ranges from 7/12 to 14/12.

- a. The buildings facing the street must follow all design guidelines for new construction. The interior units need not meet the design guidelines for setbacks and rhythm of spacing on the street but should be subordinate to the front facing homes.
- b. Interior dwellings should be “tucked-in” behind the buildings facing the street.
- c. Direct pedestrian connections should be made between the street and any interior units.
- d. Attached garages are only appropriate for rear units along the alley.
- e. The principal façade of a home should not face the rear or side of another home.
- f. The development should include a common space that is at least 1/3 of the total acreage of the site is required. Front and side yards and parking areas are not considered common space.
- g. Patios, and decks are not appropriate for the front setbacks of this building type.

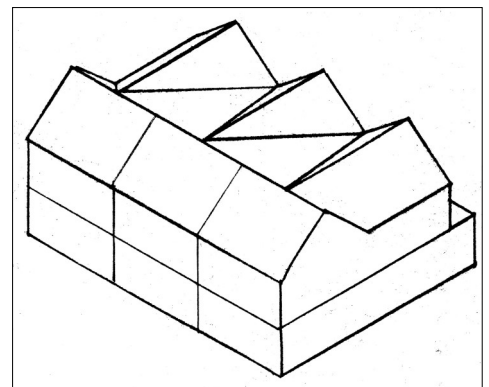

Townhouse Building Type.

III. NEW CONSTRUCTION

4. Townhouse (Row House) Building Type

A Townhouse is a low-rise attached structure consisting of two or more single-family dwelling units placed side-by-side. It occupies the full frontage of its lot, and generally eliminates most side yards. Vehicular access is from the fronting street or alley and a primary pedestrian entrance for each unit is located along the primary street frontage.

- a. Small courtyards, arcades, recessed entries or other similar entry designs may be desirable to provide privacy to ground floor residents.
- b. Each ground floor unit should have a porch, stoop, or other defined principal entrance facing the street with a walkway leading to the sidewalk. Where possible, these connections between street and entrance should be direct. Where grade dictates, the stairs may be parallel to the building but should generally directly address the street.
- e. The building type may be flat with parapet or front gabled. Typical pitch ranges from 7/12 to 14/12. Mansard roofs are inappropriate.
- f. Patios, and decks are not appropriate for the front setbacks of this building type.

5. Corner Commercial Building Type

A Corner Commercial buildings is 1 or 2 stories with a commercial-use or mixed use. At least one primary pedestrian entrance is provided along the primary street frontage and a secondary entrance may be along the side street. These buildings are typically narrower than other commercial types, less than 50' wide across the front. Vehicular access is from the alley. These buildings may occupy the full frontage of its lot, eliminating most side yards except for instances of required public pedestrian passages from the rear of the lot. This building type typically has a flat roof with parapet.

III. NEW CONSTRUCTION

6. Low-Mid Rise, Mixed Use & Commercial Building Type

A Low-Mid Rise, Mixed Use & Commercial types have either residences, a non-residential use or a mix of uses. At least one primary pedestrian entrance is provided along the primary street frontage. Vehicular access is from the alley. The building may occupy the full frontage of its lot, eliminating most side yards except for instances of required public pedestrian passages from the rear of the lot, or parking areas located on the side of the building. Siting of such buildings should provide desirable streetscape characteristics: pedestrian oriented businesses and shops at ground level, corner entrances, and a consistent building edge at least 12' feet from the sidewalk. The roof form is typically flat with parapet or a pitched roof.

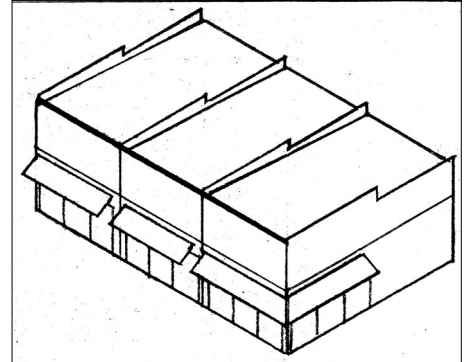

Low-Rise, Mixed Use & Commercial Building Type.

7. Civic Building Type

Civic Buildings include a wide range of structures for community use or benefit by governmental, cultural, educational, public welfare, or religious organizations. A civic building typically occupies a prominent location within a neighborhood, often at termini of roads, or within an open space. The mass and siting of a civic building may differ from the surrounding buildings to stand out as an important and recognizable landmark within the neighborhood. Roof form varies.

III. NEW CONSTRUCTION

Summary of Building Types. Please also previous text for additional guidance.

Building Type	# of stories, depending on zone	Roof forms	Development Zone
House	1-2	side and front gables, hipped and pyramidal, hipped with gables and cross gabled forms	National Register, East, North
Plex House	1-2	side and front gables, hipped and pyramidal, hipped with gables and cross gabled forms	National Register, East, Jefferson, North
House Court	1-2 in front, 1 interior	side and front gables, hipped and pyramidal, hipped with gables and cross gabled forms	National Register, Werthan Complex, East, Jefferson, North
Townhouse	1-2	flat with parapet or front gabled	National Register, Werthan Complex, East, Jefferson, North
Corner Commercial	1-2	Flat with parapet	National Register, Rosa L. Parks, East, North
Low-Mid Rise, Mixed Use & Commercial	2-4	Flat with parapet or pitched	National Register, Werthan Complex, Rosa L. Parks, East, Jefferson, North
Civic	Varies	Varies	National Register, Rosa L. Parks, East, Jefferson, North

III. NEW CONSTRUCTION

C. DEVELOPMENT ZONES

The district is divided into Development Zones to provide guidance on new construction that is specific to that area, particularly as relates to setback and height requirements.

1. **National Register District Development Zone:** properties located within the National Register of Historic Places boundaries.
2. **Werthan Complex Development Zone:** properties located within the Tennessee Manufacturing Company (Werthan Bag) National Register district.
3. **Rosa L. Parks Blvd. Development Zone:** properties facing Rosa L. Parks Blvd. between the Werthan Complex to the north and Jefferson Street on the south.
4. **East Development Zone:** properties that face Second Avenue North, Third Avenue North and Fourth Avenue North roughly between Monroe and Madison Streets, and the east side Fifth Avenue North between Monroe and Madison Streets.
5. **Jefferson Street Development Zone:** properties primarily along Jefferson Street. The corner lot at Jefferson and Rosa Parks shall follow guidance for the Rosa L. Parks Blvd. Development Zone.
6. **North Development Zone:** includes properties on the north side of Van Buren Street.

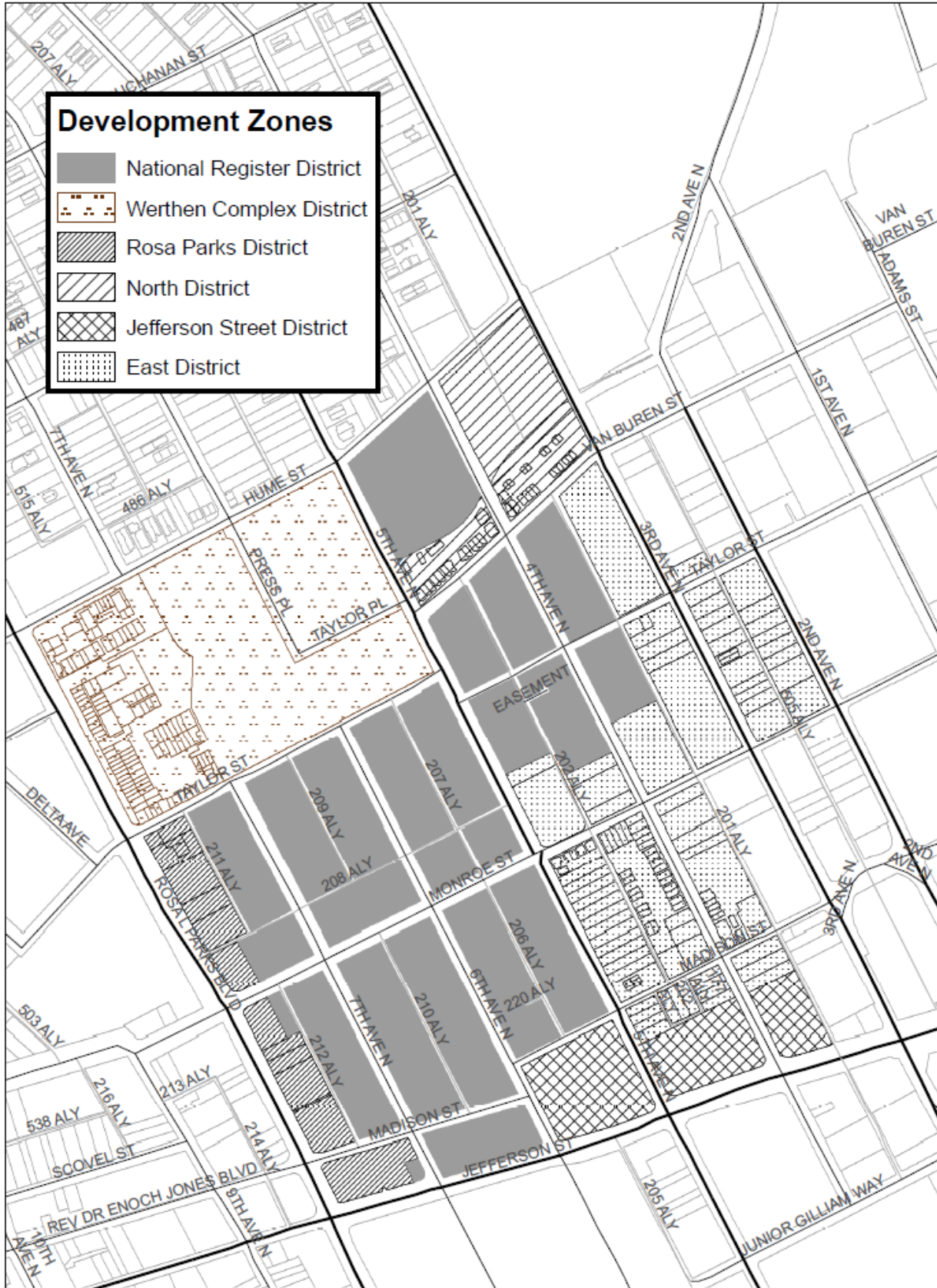

III. NEW CONSTRUCTION

D. DESIGN GUIDELINES BY DEVELOPMENT ZONE

1. National Register Development Zone

- a. Appropriate Building Types: House, Plex House, House Court, Townhouse, Corner Commercial, Low-mid-Rise Mixed Use & Commercial, Civic
- b. Setbacks
 - Commercial Building Types were typically built to the front property line/sidewalk and may extend to within 5’ of the rear property line. Generally commercial building types are not appropriate on the interior of blocks.
 - Residential building types (House, Plex House, House Court, Townhouse) are appropriate on corner and interior lots. An appropriate front setback shall be one that is approximately half-way between the setbacks of the historic buildings to either side. If the buildings to either side are not historic, are unusual for the neighborhood, or are not of the same development type, such as a church or school, then the average of the historic buildings of the same building type on the entire block face shall be used. Rear setbacks are generally deep to allow for a rear yard and outbuilding.
 - Side setbacks should be similar to the historic context in order to maintain the rhythm of the street. Often this is accomplished by matching the widths of historic buildings on the block face that are on similar sized lots.
 - Wings, porches, and secondary building elements should be at similar setbacks to existing context.
 - Corner new construction should appropriately address setbacks on both streets for corner lots.
 - Setbacks that do not meet the historic context may be appropriate for Civic Building Types.



National Register Development Zone.

III. NEW CONSTRUCTION

c. Height

- Traditionally residential portions of Germantown had 1 and 2 story homes next to each other; therefore 1, 1.5 and 2 story homes are appropriate. New construction should not exceed 2-stories (~35' for a pitched roof and ~30' for a flat roof) from grade to ridge or top of parapet wall as measured at the front two corners. Special features of limited height, such as towers or turrets may be acceptable, as long as they are kept to a minimum.
- A height that does not meet the historic context may be appropriate for Civic Building Types, depending on the massing and siting of the building.

2. Werthan Complex Development Zone

The Werthan site is a unique property within the District. At inception the site, large structures and use were an anomaly in the neighborhood. Its initial use and planning made it a center and focal point within the community. Future development on the site should recognize these unique features and new structures are encouraged to enhance the sites presence within the neighborhood.

a. Appropriate Building Types: House, Plex House House Court, Townhouse, Low-mid Rise Mixed Use & Commercial, Civic

b. Setbacks

- Setbacks along Taylor Street should be a minimum of 5' for 1-2 story buildings as seen from Taylor Street and 15' for buildings that are 3-stories as seen from Taylor Street. Setbacks on Hume Street should match the historic context.

c. Height

- The Werthan site is unique regarding building height. It shall take its context from within the boundaries of the site as opposed to adjacent properties providing context.

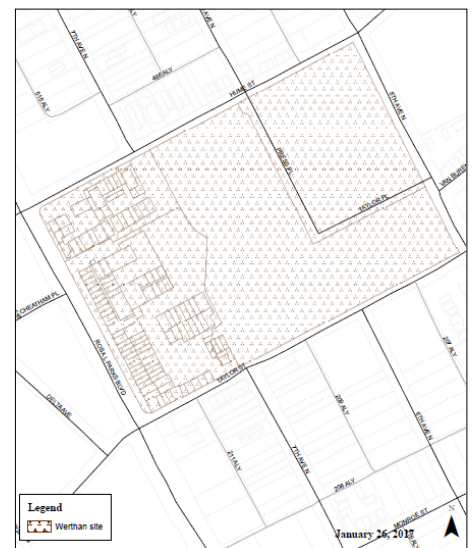

Werthan Complex Development Zone.

III. NEW CONSTRUCTION

- Houses, Plex Houses, House Courts and Townhouses should not exceed 2-stories (~35' for a pitched roof and ~30' for a flat roof) from existing grade to ridge or top of parapet wall as measured at the front two corners. Low-mid Rise Mixed Use & Commercial Building Types should not exceed the height of historic buildings within the Tennessee Manufacturing Company (Werthan Bag) National Register district., which is 4-stories with heights that vary between approximately 35' and 65'.
- A height that does not meet the historic context may be appropriate for Civic Building Types, depending on the massing and siting of the building.

3. Rosa L. Parks Development Zone

- Appropriate Building Types: House Court, Low-mid-Rise Mixed Use & Commercial, Corner Commercial, and Civic
- Setbacks
 - Siting of buildings should provide desirable streetscape characteristics: pedestrian oriented businesses and shops at ground level, corner entrances and a consistent building edge within 12' of the sidewalk, similar to the Werthan complex.
- Height
 - Buildings are permitted to be up to 4 stories (~45') along Rosa Parks with the potential of a 5th story stepped back from all street facing facades a minimum of 10'. Darker colors are encouraged for the stepped back level to help mitigate the perception of additional height. The first level may be 12'-16' tall with upper levels being less than the first floor level. Upper levels should not exceed the height of the ground floor.
 - The height should taper down to 2 stories (35' for a pitched roof and 30' for a flat roof), including the basement level, if the building



Rosa L. Parks Development Zone.

III. NEW CONSTRUCTION

continues into the back second half of the lot. The lower height is to transition from the height and massing appropriate on Rosa L. Parks and the historic “interior” of the neighborhood, which is much smaller in scale.

4. East Development Zone

a. Appropriate Building Types: House, Plex House, House Court, Townhouse, Corner Commercial, Low-mid-Rise Mixed Use & Commercial, Civic

b. Setbacks

- Commercial Building Types were typically built to the front property line/sidewalk and may extend to within 5’ of the rear property line. Generally commercial building types are not appropriate on the interior of blocks.
- Residential building types (House, Plex House, House Court, Townhouse, and Low-mid Rise Flats) are appropriate on corner and interior lots. An appropriate front setback shall be one that is approximately half-way between the setbacks of the existing buildings to either side. If the buildings on either side are unusual for the neighborhood or are not of the same development type, such as a church or school, then the average of the existing buildings of the same building type on the block face shall be used. Rear setbacks are generally deep to allow for a rear yard and outbuilding.
- Side setbacks should be similar to the context in order to maintain the rhythm of the street. Often this is accomplished by matching the widths of historic buildings on the block face that are on similar sized lots.
- Wings, porches, and secondary building elements should be at similar setbacks to existing context.
- Corner New construction should appropriately address setbacks on both streets for corner lots.

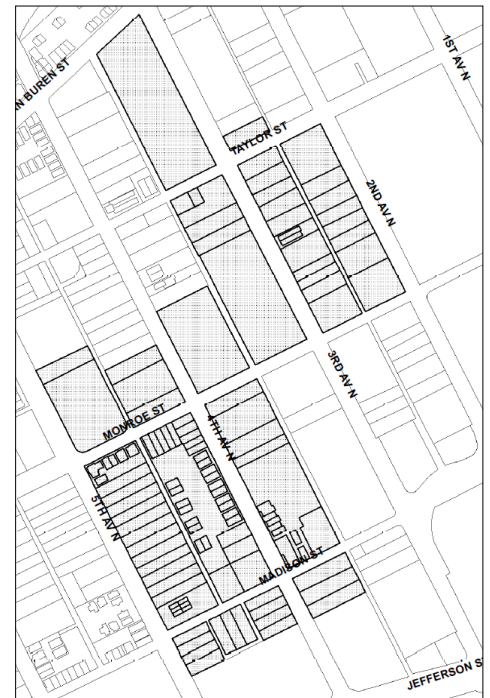

East Development Zone

III. NEW CONSTRUCTION

- Patios, and decks are not appropriate for the front setbacks of residential building types.
- Setbacks that do not meet the historic context may be appropriate for Civic Building types.

c. Height

- Traditionally the residential portions of Germantown had 1 and 2 story homes next to each other; therefore 1, 1.5 and 2 story homes are appropriate. New construction should not exceed 2-stories (~35' for a pitched roof and ~30' for a flat roof) from grade to ridge or top of parapet wall as measured at the front two corners. Special features of limited height, such as towers or turrets may be acceptable, as long as they are kept to a minimum.
- A height that does not meet the historic context may be appropriate for Civic Building Types, depending on the massing and siting of the building.

5. Jefferson Street Development Zone

a. Appropriate Building Types within the Jefferson Street Development Zone: Plex House, House Court, Townhouse, Courtyard Flat, Low-mid-Rise Mixed Use & Commercial, Mixed Use & Commercial, Civic

b. Setbacks

The setback shall match the existing context along Jefferson. Deeper setbacks along the side streets may be necessary to match the historic contexts on those streets.

c. Height

Building Types in this zone are permitted to be up to 4-stories (45') with the potential of a 5th story stepped back from all street facing facades a minimum of 10'. Darker colors are encouraged for the stepped back level to help mitigate the perception of additional height. The first level may be 12'-16' tall with upper levels being less than the first floor level. Upper levels should not exceed the height of the ground floor.

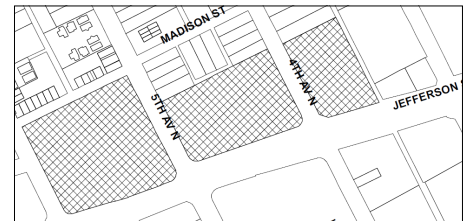

Jefferson Street Development Zone.

III. NEW CONSTRUCTION

6. North Development Zone

a. Appropriate Building Types in the North Development Zone: House, Plex House, House Court, Townhouse, Courtyard, Corner Commercial, Low-mid-Rise Mixed Use & Commercial, Civic

b. Setbacks

The setbacks shall match the existing context.

c. Height

- Traditionally the residential portions of the neighborhood had 1 and 2 story homes next to each other; therefore 1, 1.5 and 2 story homes are appropriate. New construction should not exceed 2-stories (~35' for a pitched roof and ~30' for a flat roof) from grade to ridge or top of parapet wall as measured at the front two corners. Special features of limited height, such as towers or turrets may be acceptable, as long as they are kept to a minimum.
- A height that does not meet the historic context may be appropriate for Civic Building Types, depending on the massing and siting of the building.

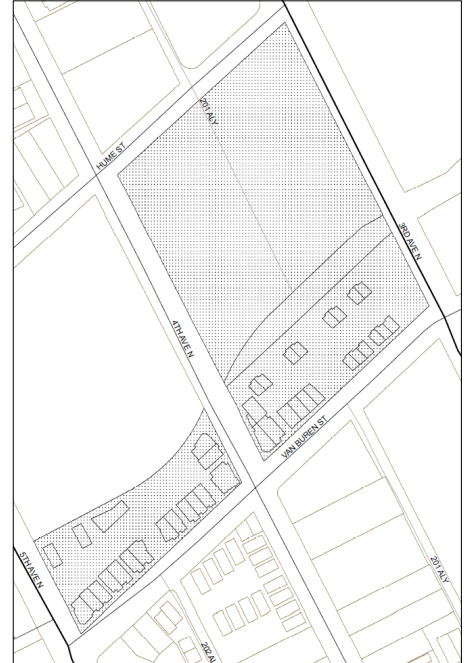

North Development Zone

III. NEW CONSTRUCTION

Summary of Development Zones. Please refer to text for additional guidance.

Development Zone	Setback	Height	Appropriate Building Types
National Register	Follows historic context	1-2 stories	House, Plex House, House Court, Townhouse, Corner Commercial, Low-mid-Rise Mixed Use & Commercial, Civic
Werthan Complex	Taylor Street-5'-15', depending on height	1-2 stories or 1-4 stories, depending on building type	House Court, Townhouse, Low-mid-Rise Mixed Use & Commercial
Rosa L. Parks	Minimum of 12'	4-stories tapered down to 2 and with a stepped back 5th story	Corner Commercial, Low-mid-Rise Mixed Use & Commercial, and Civic
East	Depends on building type	1-2 stories	House, Plex House, House Court, Townhouse, Corner Commercial, Low-mid-Rise Mixed Use & Commercial, Civic
Jefferson Street	Follows context	1-4 stories with a stepped back 5th story	Plex House, House Court, Townhouse, Low-mid-Rise Mixed Use & Commercial, Civic
North	Follows context	1-2 stories	House, Plex House, House Court, Townhouse, Corner Commercial, Low-mid-Rise Mixed Use & Commercial, Civic

III. NEW CONSTRUCTION

E. DESIGN GUIDELINES FOR NEW CONSTRUCTION IN ALL ZONES

1. General Policy

- a. This section provides design guidelines for all new construction. Additional guidance is provided based on the Building Type proposed and the Development Zone in which the project will be located.
- b. Guidelines apply only to the exterior of new construction. Public facades shall be more carefully reviewed than non-public facades. Public facades are visible from the public right-of-way, street, alley or greenway. Non-public facades are not visible from the public right-of-way, street, alley, or greenway.
- c. Construction in the District has taken place continuously from the mid-19th century through the present and a variety of building styles and building types have resulted. This variety reflects the style, culture, and values of the District over time. New construction that imitates historic architectural styles may compromise the value of authentic historic structures by confusing genuine history with reproduction. Exterior building design should avoid the creation of themed environments that create a false sense of being in an alternate time or place. The architectural building types of new buildings should be appropriate to the general context of the historic portions of the neighborhood but may be contemporary in design.
- d. Because new buildings should relate to an established pattern and rhythm of existing buildings as viewed along both the same and opposite sides of a street, a dominance of the pattern and rhythm should be respected and not be disrupted.
- e. New construction should be consistent and compatible with existing buildings along a street in terms of height, scale, setback, relationship of

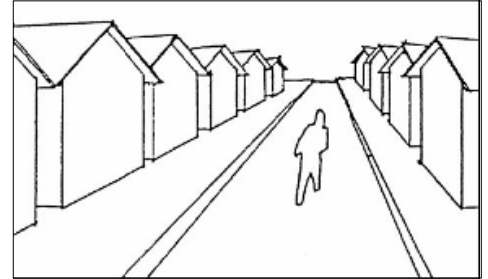

Appropriate contextual setback.

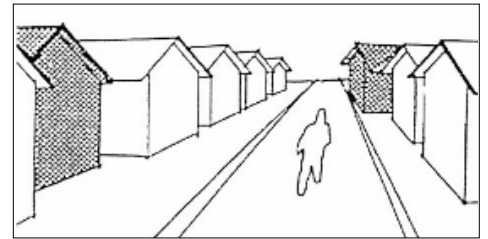

Inappropriate contextual setback.

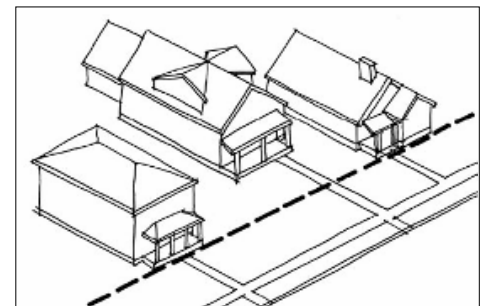

Inappropriate contextual setback.

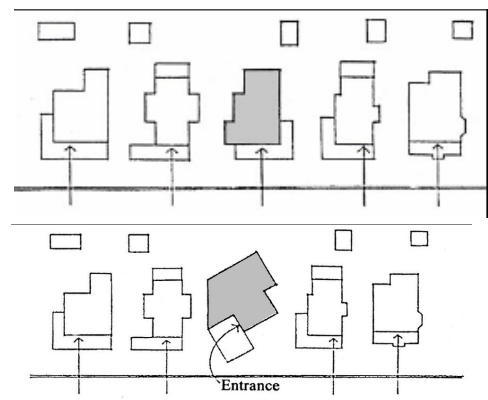

*Appropriate orientation, siting and lot coverage (top);
inappropriate (bottom).*

III. NEW CONSTRUCTION

materials, texture and color; roof shape; orientation; and proportion and rhythm of openings.

- f. Buildings should be sited on their respective parcels in ways that are appropriate to the general context of the historic portions of the neighborhood.

2. Setbacks

- a. Specific setbacks will depend the “Development Zone” in which the property is located, the “Building Type” proposed, and the immediate context.
- b. It is the intent of these guidelines to avoid the arbitrary establishment of setbacks resulting in haphazard building placement and a resulting interruption or absence of visual order within the District.
- c. *Setback Determinations. The Commission has the ability to determine the bulk standard (setbacks and height) requirements (ordinance no. 17.40.410) for each lot. When the Commission finds that a setback is less than what is required by the zoning code’s bulk standard is appropriate, it is called a “Setback Determination”.*

Setback determinations may be appropriate when:

- *The existing setbacks of the contributing primary building does not meet bulk standards;*
- *Original setbacks of like structures historically found on the site as determined by historic maps, site plans or photographs; or*
- *Shape and size of lot makes meeting bulk standards unreasonable.*

3. Orientation

- a. The orientation of a structure's primary facade shall be consistent with those of adjacent historic buildings or existing buildings where there is little historic context. This typically means that a primary



This apartment building incorporates architectural elements that create a human scale, such as bay windows, cornice lines, double hung windows, building modulation, and horizontal banding. Also, the street front landscaping helps it to better fit in an established neighborhood..

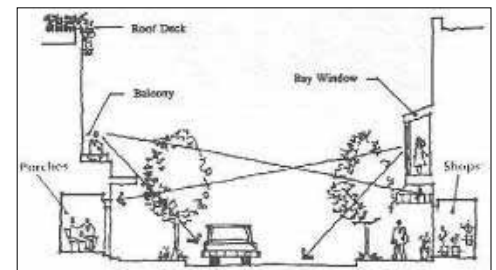

Elements along the street front that promote a human scale on the street.

III. NEW CONSTRUCTION

entrance faces the street and has walkways leading from the entrance to the sidewalk.

b. Vehicular orientation is typically an access from the alley. Porte cocheres, front-yard parking and front loading driveways are atypical of the district.

c. The intent is to encourage pedestrian oriented development, interaction with the street environment and allow for transition between the street/public domain and the interior of the building/private domain. Entries that are visible from the street generally make a building more approachable and create a sense of association among users, customers and neighbors. Clear entries should be provided off of public streets not solely from parking lots.



Appropriate mass and scale (top); inappropriate (bottom).

4. Façade Articulation

a. New structures shall employ design techniques that avoid large expanses of unbroken façade planes and/or materials, particularly on public facades.

b. For multi-story buildings, the width of any unbroken façade shall not exceed the building height. This width to height ratio is considered a minimum – more modulation is encouraged. Some appropriate techniques for building articulation include but are not limited to:

- Modulating the façade by stepping back or extending forward a portion of the façade . Articulating a building’s façade vertically and/or horizontally in intervals are informed by existing patterns or structures within the Germantown is encouraged;
- Pilasters, recesses and or projections;
- Repeating window patterns at an interval that equals the articulation interval; and/or
- Changing the roof line by varying parapet heights, alternating dormers, stepped roofs, gables or other roof elements to reinforce the modulation or articulation interval and changing materials with a

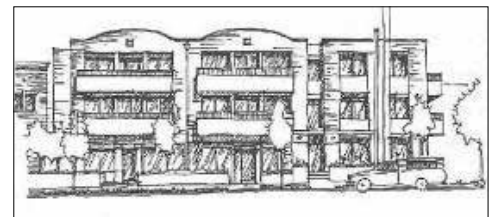

This mixed-use building expresses intervals through modulation, a mix of roof forms, landscaping and other elements.

III. NEW CONSTRUCTION

change in building plane. Changes in a materials, texture or color are appropriate techniques – however changes solely in paint color alone are generally not sufficient to meet the intent of this guideline.

5. Materials

- a. The relationship and use of materials, texture, details and material color of a new buildings shall be visually compatible with and similar to or shall not contrast conspicuously with those of adjacent historic buildings.
- b. The MHZC does not review paint color on wood. The MHZC reviews the inherent color of new materials, such as masonry and metal. Generally, painting masonry materials is inappropriate for existing and new construction.
- c. The color of masonry should be similar to historic colors of the same or similar materials. Traditional brick colors range from red-oranges to dark red. The use of “antique” reproduction or multi-colored brick is not permitted.
- d. Materials not listed in section e and f may be appropriate, if they possess characteristics similar in scale, design, finish, texture, durability, workability and detailing to historic materials and meet The Secretary of the Interior’s Standards.
- e. Foundation Materials:
 - Appropriate materials: brick, limestone, pre-cast stone if of a compatible color and texture to existing historic stone clad structures in the district, split-face concrete block, parge-coated concrete block
 - Inappropriate materials: dry-stack stone and “rubble stone” veneers
 - Intervening spaces of pier foundations may be filled with an open lattice work.



1210 7th Avenue North is an example of a terra-cotta colored brick.

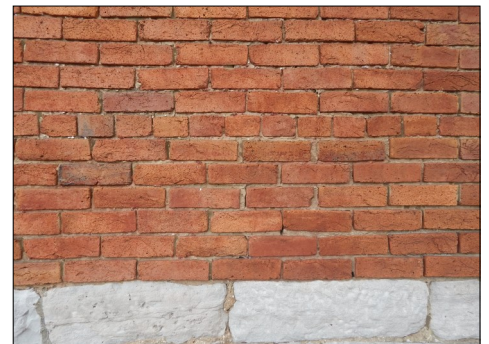

1234 6th Avenue North is an example of a red – orange brick color..

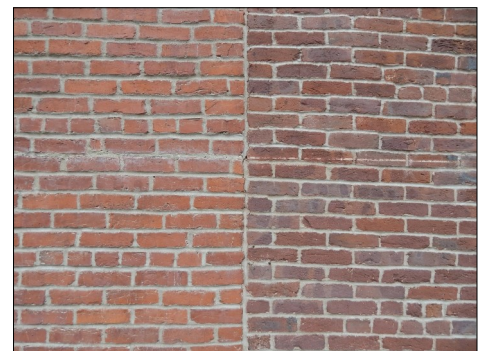

The Assumption Church is a good example of the range of brick colors typical of the district. Different eras of construction at the church show different brick colors.

III. NEW CONSTRUCTION

- Slab-on-grade foundations may be appropriate for commercial building types but they are generally not appropriate for residential building types.

f. Facade Materials:

- All facades shall be at least 80% brick. Appropriate accent materials include stucco, fiber-cement or metal panels, fiber-cement, milled and painted wood, or metal horizontal siding. A greater percentage of accent materials may be used on facades that are not visible from a public right-of-way. A greater percentage of accent materials may be appropriate to create a more varied and appropriately neighborhood scaled building façade and massing with the Werthan and Rosa Parks Development zone.
- Lap and horizontal siding should have reveals that do not exceed 5”.
- Inappropriate materials: T-1-11- type building panels, "permastone", E.F.I.S., vinyl, aluminum, rustic and/or unpainted wood siding, stud wall lumber, embossed wood grain materials. Stone, board-and-batten and half-timbering are uncommon cladding materials in Germantown and are generally not appropriate.
- Texture and tooling of mortar on new construction should be similar to historic examples.
- Four inch (4”) nominal corner boards are required at the face of each exposed corner for non-masonry walls.
- Belt courses or a change in materials from one story to another are often encouraged for large two-story buildings to break up the massing. When different wall materials are used, it is most appropriate to have such changes occur at floor lines.

g. Accent and Trim Materials:

- Appropriate materials: wood or fiber cement
- Shingle siding is appropriate as an accent material and should exhibit a straight-line course pattern or a fish scale pattern and exhibit a

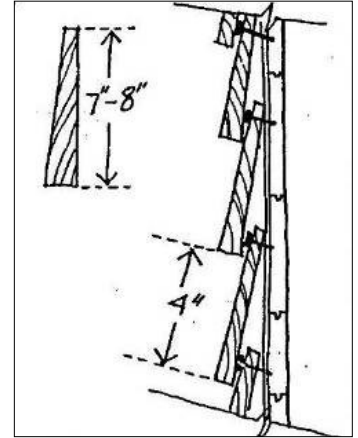

Typical siding lap



Appropriate window and door styles (top); inappropriate (bottom).

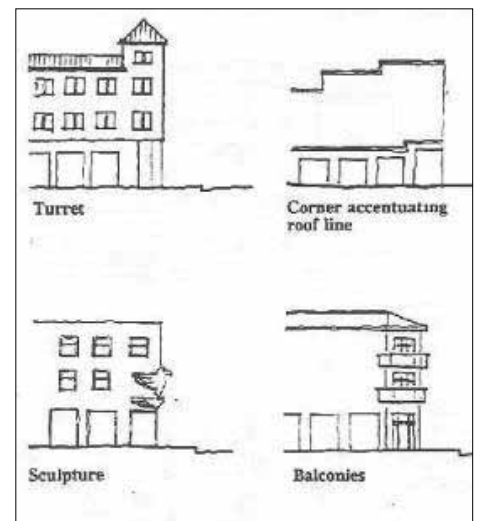

Conner entries and/or architectural features are encouraged.

III. NEW CONSTRUCTION

maximum exposure of seven inches (7").

- Wood trim and accents were typically painted and milled. Rustic timbers and unpainted wood is generally inappropriate.
- Composite materials may be appropriate for trim if they match the visual and durability characteristics of wood.
- Stucco/parge coating may be appropriate cladding for a new chimney or a foundation.

h. Roofs and Chimneys Materials:

- Appropriate roof materials: Asphalt shingle and standing seam metal
Generally, asphalt shingle roofing should not have strong simulated shadows in the granule colors which results in a rough, pitted appearance; faux shadow lines; strongly variegated colors; colors that are light (e.g.: tan, white, light green); wavy or deep color/texture used to simulate split shake shingles or slate; excessive flared form in the shingle tabs; uneven or sculpted bottom edges that emphasize tab width or edges, unless matching the original roof.
- Rolled roofing material, such as EPDM, is appropriate for low-sloped roof planes that are not visible from the right-of-way.
- Appropriate chimney materials: masonry or stucco
- Inappropriate chimney materials: clapboard/lap siding

i. Door & Window Materials:

- Front doors shall be painted or stained wood or painted metal and be at least half-glass.
- Tinted, reflective, or colored glass are generally inappropriate for windows or doors.
- For new commercial structures a significant portion of the street level façade (i.e., doors and windows) shall be transparent to provide visual interest and pedestrian access.
- Windows on residential buildings or upper level facades of commercial/mixed-use buildings may be fixed, casement, single or double hung window sashes. Single-light (also known as 1/1) window sashes are appropriate for new construction. If using multi-light sashes, muntins should be fully simulated and bonded to the

III. NEW CONSTRUCTION

glass, and exhibit an interior bar, exterior bar, as well as a spacer between glass panes.

- Four inch (nominal) casings are required around doors, windows and vents on non-masonry buildings. Trim should be thick enough to extend beyond the clapboard. Double or triple windows should have a 4" to 6" mullion in between.
- Brick molding is required around doors, windows and vents within masonry walls. The use of brick molding on non-masonry buildings is inappropriate.
- Door openings should be recessed (2" minimum) on masonry buildings, as they are traditionally, rather than flush with the rest of the wall.

j. Walkways, Sidewalks & Curbing Materials:

- For the purpose of these design guidelines, "sidewalks" are those that parallel the street in the public realm and "walkways" are typically on private property and lead from the sidewalk to a principal entrance.
- Materials for new appurtenances should be in keeping with the look, feel and workability of existing historic materials.
- New sidewalks shall be brick, with the exception of sidewalks on Rosa L. Parks Blvd and Jefferson Street, which may be brick or concrete.
- Brick, concreted, concrete pavers, stone and stepping stones are appropriate walkway materials.
- Planting strips are not appropriate in the interior of the district but may be appropriate on Rosa L. Parks Blvd.

k. Front Yard Fencing and Walls:

- Front yard fences can be up to 4' in height and shall generally have an open design.
- Appropriate materials: wood picket, metal fencing of simple design. Stone is an appropriate material for retaining walls. New stone should match existing historic retaining walls with characteristics similar in scale, design, finish, texture, durability, and detailing.
- Inappropriate materials: chain link or wrought iron fences are generally not appropriate for front or visible side yards. Salvaged metal fencing and dry stack masonry are not appropriate for new construction.

III. NEW CONSTRUCTION



Examples of appropriate front yard (street) fencing.

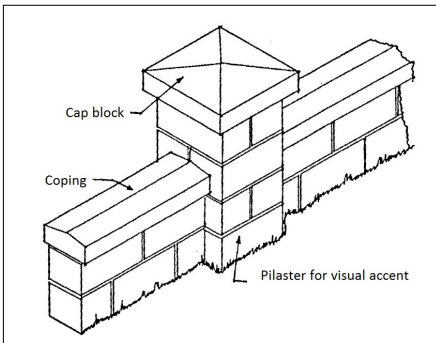

Examples of existing retaining walls.

Construction detail of a front yard retaining wall.

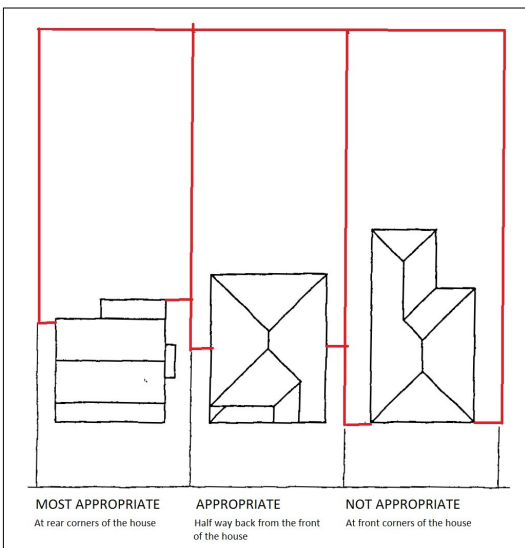

Examples of privacy fencing on side or rear lot lines.

Appropriate and inappropriate locations for rear yard fencing.

III. NEW CONSTRUCTION

1. Rear Yard Fencing and Walls:

A rear yard is considered to be any location beyond the mid-point on the side facades of a building and surrounding the rear yard.

- Appropriate materials: wood planks, iron, and masonry and mortar may be appropriate along rear property lines. Stone with mortar and concrete are appropriate materials for retaining walls. New stone should match existing historic retaining walls with characteristics similar in scale, design, finish, texture, durability, and detailing.
- Inappropriate materials: Dry-stack masonry
- Privacy fences in rear yards can be up to 6' in height and solid in design.

6. Rhythm Of Solids-To-Voids & Proportions Of Openings

- a. Large expanses of featureless wall surface are not appropriate. *In most cases, every 8-13 horizontal feet of flat wall surface should have an opening (window or door) of at least 4 square feet. More leniencies can be given to minimally visible side or rear walls.*
- b. The relationship of width to height of doors and windows and the rhythm of solids (walls) to voids (windows and doors) should be compatible with surrounding buildings.
- c. Exterior doors often have transoms, giving them a tall, narrow proportions.
- d. Window openings on the primary street-related or front façade of new construction should be representative of the window patterns of similarly massed historic structures within the district.
- e. Double-hung windows should exhibit a height to width ratio of at least 2:1.

III. NEW CONSTRUCTION

- f. Windows on upper floors should not be taller than windows on the main floor since historically first floors have higher ceilings than upper floors and so windows were typically taller on the first floor.
- g. On corner commercial buildings, glazing shall address both streets.

7. Primary Entrances

- a. Within the district, front porches, stoops and hoods, and recessed entries are common on residential and commercial buildings.
- b. Primary entrances shall be in locations similar to those used historically for primary entrances.
- c. New construction (specifically residential) shall provide an entry that utilizes elements of a porch or recessed entry to create a transition from the outside (public domain) to the inside (private domain).
- c. Entrances to commercial buildings should be recessed.

8. Roof

- a. The roofs of new buildings should be visually compatible by not contrasting significantly with the roof shape, pitch, and orientation of surrounding buildings. See Building Type descriptions.
- b. Roof-top equipment, skylights, and roof penetrations located on or attached to the roof shall be located so as to minimize their visibility from the street. Typically screening does not meet the requirement for “minimal visibility” as it often alters the look and perceived height of a building. Generally, rooftop equipment should be placed behind the mid-point of the building. (For solar panels, please see “utilities.”)

III. NEW CONSTRUCTION

9. Rooftop Decks

- a. Rooftop decks (flooring, railing and access structure) shall not be added to historic buildings.
- b. Rooftop decks are not appropriate on new construction within the National Register Development Zones but may be appropriate in other Development Zones.
- c. Rooftop decks are not appropriate for single-story new-construction.
- d. Where Rooftop decks are appropriate:
 - They should not cantilever or project from the building.
 - The lighting of roof decks should point inward and downward and not be located more than 42” above the deck. The access structure shall not be illuminated, other than safety lighting near the entrance.
 - No rooftop deck may be raised more than two feet (2’) above the plane that is midway between the lowest and the highest points of the roof surface supporting the rooftop deck.
 - A rooftop deck should sit back from the front wall of the building by at least 8’ for a flat roof and 6’ behind the ridgeline for a gabled roof or mansard roof. It should sit back a minimum of 5’ from the side street-facing wall in the case of corner buildings.
- h. Mechanicals or other elements shall not be located on top of a rooftop access structure.
- i. Roof decks shall not have outside A/V equipment (for instance televisions and speakers but not including small security cameras), flags, signage, permanently installed structures such as pergolas, other than the access structure, or permanently installed furniture and appurtenances.
- j. Access structures may only serve to enclose a single-door access, stair or elevator. Access structures should have flat or slight slope roofs and

III. NEW CONSTRUCTION

not exceed 9' in height. The 9' may be in addition to the maximum height allowed based on context, if the rooftop access structure is positioned in a minimally visible location.

10. Utilities / Mechanical

- a. Utility connections such as gas meters, electric meters, electric service mast and power lines, phone, cable, satellite TV and HVAC condenser units should be located so as to minimize their visibility from the street.
- b. Exterior utilities and mechanical equipment shall generally be located in the rear or side yard and screened when visible from the street.
- c. Solar panels should be located on the back of pitched roofs or on outbuildings, where possible. They should be installed to be flush with the roof pitch unless hidden behind a parapet wall, in which cases; they should not protrude above the parapet wall.
- d. Satellite dishes shall be located beyond the midpoint of the building. In the case of corner lots, a satellite dish should be located on the interior side, beyond the midpoint.
- e. Modern rooftop elements such as mechanical units, ducts, antenna, and vents should not be readily visible from the public right-of-way.
- f. Security cameras should be installed in the least obtrusive location possible. Select camera models that are as small in scale as possible.

11. Sidewalks & Walkways

For the purpose of these design guidelines, "sidewalks" are those that parallel the street in the public realm and "walkways" are typically on private property and lead from the sidewalk to a principal entrance. (Please also see "materials.")

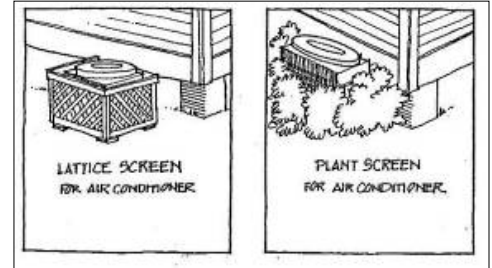

Outdoor HAVA components should be screened by planting or low fencing. Make sure space is left around the unit for air flow..

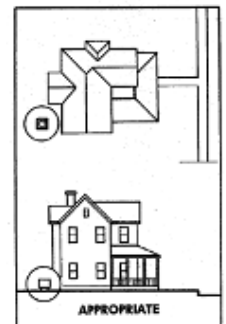
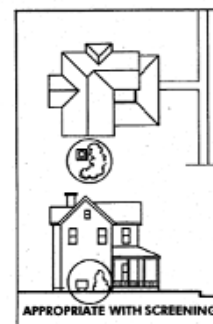

Install mechanical equipment in areas that will require the least possible alteration.

III. NEW CONSTRUCTION

- a. Curb cuts on public streets are generally not appropriate. Removal of existing curb cuts on primary streets (where a lot can be accessed from the alley) is encouraged to bring non-conforming properties into conformance.
- b. Original sidewalks and walkways, including details such as original retaining walls, stone and concrete edgings, and brick sidewalks, etc., shall be preserved in their original state as closely as possible. Special care shall be taken to preserve existing trees and significant landscape elements.
- c. Where historic sidewalks are no longer in existence, new sidewalks should be of brick in the dominant pattern closest to the development. A typical pattern for the neighborhood is a herringbone pattern or running bond.
- d. Pathways and walkways providing access to buildings shall be serviceable and relate to the building in scale, width, placement and type of material.

12. Exterior Lighting

See "Rooftop Decks" for lighting guidance regarding rooftop decks.

- a. Exterior lighting fixtures shall be compatible in style, size, scale and material with the character of the structure and neighborhood.
- b. Lighting shall not spill onto adjacent structures, or properties.
- c. Permanently installed lighting may be used to highlight architectural features and to illuminate walkways, parking, and signage and should be a daylight color.
 - Lighting to illuminate walkways and parking should be ground-mounted with the light directed toward the ground, rather than be pole mounted.
 - Building lighting should be directed toward the façade instead of outward. Architectural features may be illuminated through

III. NEW CONSTRUCTION

uplights. It is inappropriate to wash an entire building or façade with light.

- Ground mounted spotlights shall be screened from public view.
- Dark metals or a color that matches the wall the light is installed on are appropriate materials for light fixtures.
- Inappropriate types of lighting including: flashing, chasing or moving lights, neon lighting, multi-colored lighting.
- Rope and string lighting is only appropriate in ground-floor locations where neither the fixture nor the illumination is visible from a public right-of-way or where it is located beneath ground-floor awnings or canopies.
- See section for “signage” for illuminating of signage.

13. Open Space & Surface Parking

- Removal or demolition of existing historic buildings, or portions of buildings, to create open space or surface parking is not appropriate.
- Generally, surface parking should have its vehicular access on the alley.
- The most appropriate treatment for vacant lots is construction of a new building; however, when that is not possible, the area may be used as open space with features such as:
 - Visual and pedestrian access into the site from the public sidewalk;
 - Walking surface of attractive pavers;
 - Pedestrian scaled site lighting;
 - Public art;
 - Outdoor seating or dining (also see design guidelines for sidewalk cafes).
- Open space or surface parking shall maintain the pattern of the street wall with a 3’ wall, fence, planter box or other barrier located at the appropriate front-setback.

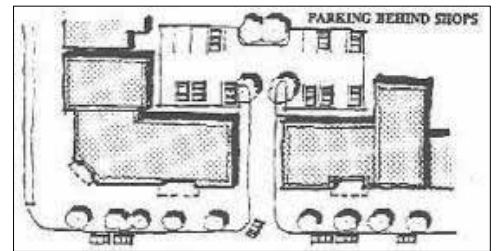

Parking lots located behind shops and offices are preferred.

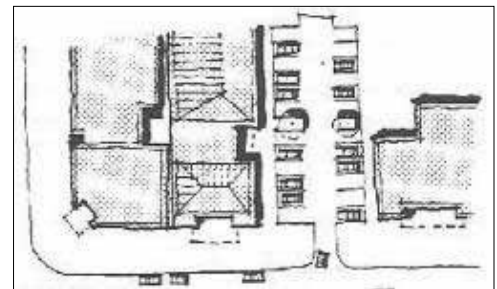

In certain situations limited street-front parking lots may be acceptable.

III. NEW CONSTRUCTION

- e. Outdoor furniture (seating, tables, umbrellas, etc.) that are not permanently installed, shall not be reviewed.
- f. Signage is generally not appropriate in open space areas, with the exception of wayfinding and historical marker signage.
- g. Audio/visual equipment, such as televisions and speakers, is not appropriate on the exterior of buildings or in open space areas.
- h. Preparation equipment, service areas and furnishings that require piping including a water supply and/or drainage or a permanent utility line; readily movable appliances operated by a portable propane gas tank, such as a barbecue grill, or a furnishing using temporary piping such as a garden hose should be screened from view and shall not be covered.
- i. Food and beverage storage shall be screened from view of the public right-of-way.
- j. Open space should generally not be covered. Exceptions may be made for small garden structures.

14. Sidewalk Cafes & Commercial Plazas

Sidewalk cafes must meet the public right-of-way encroachment requirements as required by city ordinance and cannot cause a sight distance issue or obstruct the sidewalk/ pedestrian path of travel. The process for approval of an encroachment in or over a public right-of-way begins in the Metro Public Works Permits Office.

- a. Front plazas are only appropriate for the Low-mid Rise Mixed Use & Commercial Building Type.
- b. Use of metal or wood materials with a simple open design, movable posts and rope, or narrow planter boxes, no more than 32" tall, to fence in sidewalk café areas or plazas, are appropriate.

III. NEW CONSTRUCTION

- c. Sidewalk café or plaza elements should not be attached to the building.
- d. Sidewalk café and plaza elements shall not be covered or enclosed (roof, walls), in any way, temporarily or permanently. Tables may be covered by non-permanent canvas umbrellas.
- e. A/V equipment, such as televisions and speakers, and signage are not appropriate in sidewalk cafes or plazas.

15. Parking Structures

- a. Removal or demolition of existing historic buildings, or portions of buildings to create a parking structure is not appropriate.
- b. Parking structures, may be appropriate components of new construction when the design of such development contributes to the overall character of the district and the streetscape, and the structure is consistent with the design guidelines for new construction.
- c. Parking structures should be wrapped with retail or residential space that is a minimum of 15' deep.
- d. Generally parking structures should be accessed from the alley.
- e. All parking structures with parking available to the public shall have a clearly marked pedestrian entrance, separate from vehicular access, on street frontages. A publicly accessible building lobby may meet this requirement.

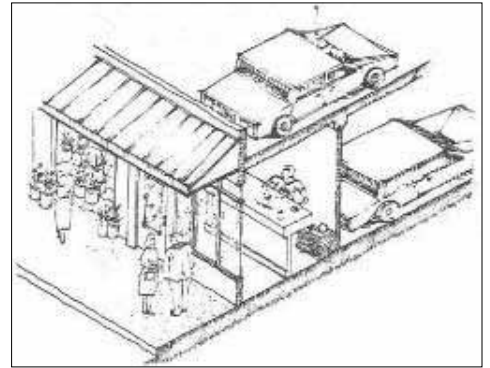

Providing space for pedestrian oriented businesses along parking garage frontage.

16. Telecommunications Facilities and Equipment

Also see ordinance for telecommunication facilities. (Article XII, Chapter 17)

- a. Appropriate locations for telecommunication facilities are:
 - Ground mounted behind a building if it is fully screened from the public right-of-way.
 - Hidden within existing poles.

III. NEW CONSTRUCTION

- Placed on rooftops, as long as the equipment cannot be seen from the public right-of way. Added screening is generally not appropriate as it can add to the perceived height of the building.
 - Incorporated into an existing architectural feature. If the feature is a historic one, the interior should be accessible without altering or changing the historic feature. New features should not be added to historic buildings unless there is pictorial evidence of their existence.
 - New features may be added to non-contributing buildings if the addition is appropriate for the district.
 - Attached to side elevations of non-contributing buildings if the size and design is minimal and the location is not visible from a public right-of-way.
- b. Historic materials should not be damaged or historic features obscured when installing telecommunications facilities and equipment.
- c. If a new pole is necessary (see ordinance for telecommunication facilities) in front of a building, it shall not entirely block the view of the width of the principal entrance and it should not exceed the 20' in height. It shall be painted black.
- d. If the pole is to be located adjacent to a vacant lot, it should not be located in the typically expected locations of a principal entrance for new construction, such as the corner and/or the center 10' of the lot.
- e. Generally new poles should not be made to look like something else; however, it may be appropriate to have it look like an acorn light pole if it meets the ordinance for spacing.

17. Appurtenances

Appurtenances include, but are not limited to, features such as curbs, steps, pavement, gravel, fountains, pergolas, pools and ponds, street furniture, bike racks, outdoor fireplaces/pits, vending, public art and mailboxes.

III. NEW CONSTRUCTION

- a. Appurtenances and other work planned in public spaces by any individual, group or agency shall be presented to the MHZC for review of compatibility with the character of the district.
- b. Appurtenances related to new buildings, should be visually compatible with the environment established by surrounding existing buildings and the site on which they are located. They should not contrast greatly with the style of associated buildings in terms of design, size, materials, material color and location and should not contrast greatly with comparable original features of surrounding buildings.
- c. Generally, mailboxes should be attached to the front wall of the house or a porch post. In most cases, street-side mailboxes are inappropriate. Screened group mailboxes (cluster mailboxes) are appropriate for the House Court Building Type. For denser Building Types, such mailboxes should be located inside a building's common area.
- d. Permanently installed front-yard fixtures such as fountains, ponds, or waterfalls are atypical for the district and not appropriate for new construction. They may be appropriate as new construction in front of historic buildings if there is documentary, physical, or pictorial evidence showing a similar original feature.
- e. An appropriate location for flags is attached to the front of a building, on a porch or near a front entrance. Front yard, free-standing flag poles are atypical, except in front of Civic Building types.
- f. Swimming pools are to be located in the rear yard or appropriately screened from view and set back from the street; fencing around swimming pools required by zoning ordinance must comply with these design guidelines.
- g. Structures such as gazebos and pergolas that are appropriately sized to the scale of the principle building should generally be located in rear or side yards.

III. NEW CONSTRUCTION

- h. Historic curbing, edging, brick sidewalks and stone retaining walls should be retained.

- i. Vending/ATMs should be located inside. In instances where outside locations are necessary, they are only appropriate for new construction and should only be located on buildings directly associated with the use of the vending. For instance, an ATM is only appropriate on a bank building. Where such is appropriate, they should not be located on primary facades and should be pedestrian oriented rather than vehicular oriented.

- j. Foundation/basement access doors shall be located on the side or rear of the building.

- k. Dumpsters and other trash containers shall be located with techniques that minimize interruption to the sidewalk network and the pedestrian environment. The most appropriate location for dumpsters and trash containers is in the rear yard or alley and screened from public view.

IV. NEW CONSTRUCTION-OUTBUILDINGS

A. GENERAL PRINCIPLES

The Commission does not review nor regulate use of an outbuilding.

B. GUIDELINES

1. Height & Scale

- a. The ridge height of an outbuilding should not exceed the primary ridge/peak height of the principle building. *The principle building should be measured from the floor line to the ridge of the main massing and the outbuilding from grade to ridge.*
- b. If the outbuilding has a second level, the knee wall of the second level shall not exceed 6’.
- c. The footprint of an outbuilding or a collection of outbuildings together shall not exceed 60% of the footprint of the principal building. All covered spaces, including features such as porches, carports, and covered walkways shall be considered part of the footprint of the outbuilding. Small hoods over stoops are not included in this calculation.

2. Character, Materials & Details

- a. The principal cladding material shall be lapsiding or brick. *Please see “New Construction” for additional guidance on materials.*
- b. Outbuildings with a second story shall enclose the stairs interior to the structure and properly fire rate them per the applicable life safety



Examples of appropriately scaled outbuildings.

IV. NEW CONSTRUCTION-OUTBUILDINGS

standards found in the code editions adopted by the Metropolitan Government of Nashville.

- c. Upper level balconies extending from a pitched roof should not exceed 86 square feet. Supportive posts are not appropriate for upper level balconies.
- d. Lighting on an outbuilding should enhance the pedestrian experience of the alley at night. This may include ground-level porch lighting, bollards or garden lights. Lighting located on the building in a location higher than 10' from grade should be directed downwards.

3. Roof

- a. Roof slopes and forms of the outbuilding should be similar to the roof slopes and form of the principal building.
- b. The outbuilding may have shed, gable or hipped roof dormers that shall be subordinate to the roof slope by covering no more than fifty percent of any one roof plane. *The width of the dormer shall be measured from side wall to side wall and the roof plane from side wall to side wall.*
- c. The front face of dormers should have primarily glazing.
- d. Skylights and solar panels are appropriate additions to the roof of an outbuilding.

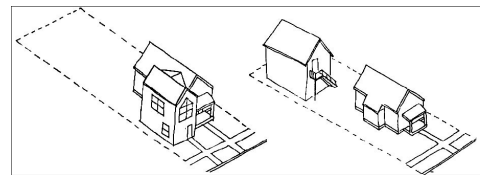

Above: Inappropriate outbuilding location.

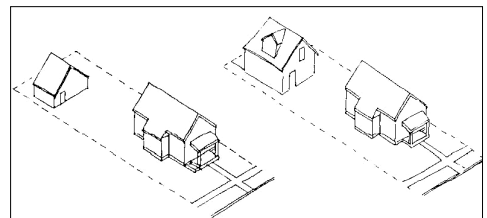

Below: Appropriate outbuilding location.

IV. NEW CONSTRUCTION-OUTBUILDINGS

5. Location, Setbacks and Site

- a. The addition of an outbuilding may not allow a property to exceed the lot coverage required in the bulk standards.
- b. Generally new garages should be placed close to the alley, at the rear of the lot, whether or not they are attached to the principal building,
- c. Rear setbacks shall be a minimum of 5'. If the alley-facing façade incorporates a balcony, the rear setback of the primary wall shall be a minimum of 8'. Additional rear setback is encouraged if the setback area is to be used as greenspace. Side setbacks may be zero but shall be 8' if the side includes an upper-level balcony.

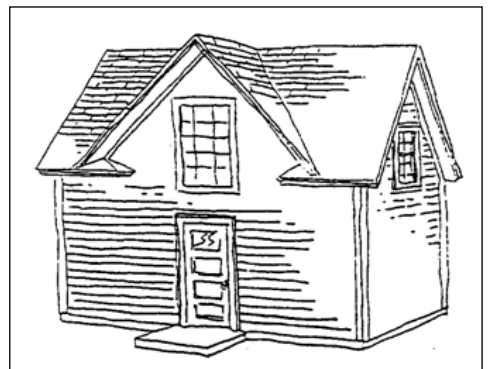
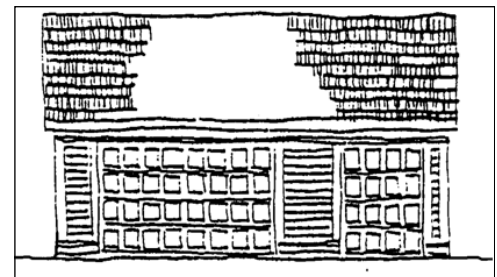

Examples of appropriate outbuildings.



V. NEW CONSTRUCTION-ADDITIONS

Also see “New Construction-infill” for information on materials, roofs, utilities/mechanicals, sidewalks/walkways, exterior lighting, appurtenances and other applicable guidance.

A. GENERAL PRINCIPLES

1. Guidelines apply only to the exteriors of new construction. Public facades shall be more carefully reviewed than non-public facades. Public facades are those that are visible from the public right-of-way, street, alley, or greenway. Non-public facades are those not visible from the public right-of-way, street alley or greenway.
2. The guidelines for New Construction shall also apply to all additions, where applicable.
3. Additions should be sited on their respective parcels in ways that are appropriate to the historic building and, in the case of non-historic buildings, in a way that is appropriate for the general context of the historic portions of the neighborhood.
4. The color of paint used on wood surfaces is not reviewed. The inherent color of materials is reviewed.
5. In the case of historic buildings, additions should be consistent and compatible with the historic buildings. In the case of non-historic buildings, additions should be compatible with historic buildings along a street in terms of height, scale, setback, relationship of materials, texture and color; roof shape; orientation; and proportion and rhythm of openings.
6. Any interior alterations that require exterior alterations or change the look of the exterior such as changing floor lines or removing load bearing walls should not be undertaken. Care should be taken during rehabilitation not to remove stabilizing factors such as plaster lathe.

V. NEW CONSTRUCTION-ADDITIONS

B. GUIDELINES FOR ADDITIONS

1. Design

- a. Additions should not obscure or contribute to the loss of historic character-defining features or materials.
- b. Additions to existing historic buildings shall be compatible in scale, materials, and texture; additions shall be visually compatible by not contrasting greatly with the existing historic building.
- c. Additions to historic buildings should be done in such a manner that, if such additions were to be removed in the future, the essential form and integrity of the original structure would not be impaired.
- d. The creation of an addition through enclosure of a front porch is not permitted. The creation of an addition through the enclosure of a side porch may be appropriate if the addition is constructed in such a way that the original form and openings on the porch remain visible and undisturbed.
- e. Contemporary designs for additions to existing historic properties may be permitted when such additions do not destroy significant historical, architectural, or cultural material; and when such design is compatible, by not contrasting greatly, with the size, scale, material color, material, and character of the property, neighborhood, or environment.

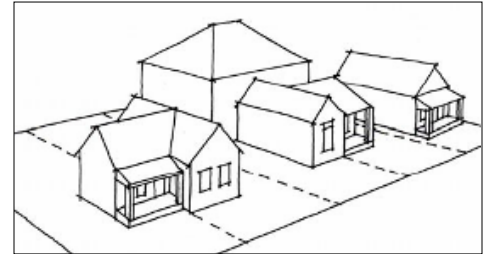

Inappropriate addition..

2. Height & Massing

- a. The height of the addition's roof, eaves and foundation must be less than or equal to the existing structure.
- b. Foundation lines should be visually distinct from the predominant exterior wall material. This is generally accomplished with a change in materials.



V. NEW CONSTRUCTION-ADDITIONS

- c. Visually evident roof slopes should match the roof slopes of the existing structure, and roof planes should set in accordingly for rear additions.
- d. In order to achieve compatibility in scale, no matter the building's use, an addition should not be larger than the existing house, not including non-historic additions.
- e. Additions should generally be shorter and narrower than the existing building. Exceptions may be made when unusual constraints make these parameters unreasonable, such as:

- *An extreme grade change*
- *Atypical lot parcel shape or size*

In these cases, an addition may rise above or extend wider than the existing building; however, generally the addition should not be higher and should not extend wider.

When an addition needs to be taller:

Whenever possible, additions should not be taller than the historic building; however, when a taller addition is the only option, additions to single-story structures may rise as high as 4' above the shadow line of the existing building at a distance of 40' from the front edge of the existing building. In this instance, the side walls and roof of the addition must set in as is typical for all additions. The portion of the roof that can be seen should have a hipped, side gable or clipped gable roof to help decrease the visual mass of the addition.

When an addition needs to be wider:

Rear additions that are wider than an existing historic building may be appropriate when the building is narrower than 30' or shifted to one side of the lot. In these instances, a structural alcove or channel must separate the existing building from the new addition. The structural alcove should sit in a minimum of 1' and be at least twice as long as it is deep. In addition, a rear addition that is wider should not wrap the rear corner.

V. NEW CONSTRUCTION-ADDITIONS

3. Placement

- a. Generally, an addition should be situated at the rear of a building in such a way that it will not disturb either front or side facades. To distinguish between the historic structure and an addition, it is desirable to set the addition in from the building's side walls or for the addition to have a different exterior cladding. A general rule of thumb is a 1' step-in for 1-story additions and a 2' step-in for 2-story additions. When an addition is small (i.e. one-room deep, 12' deep or less) and extends the full width of the a masonry building, and the addition is wood (or appropriate substitute siding), the typical insets are not necessary as the change in material from masonry to wood allows for a minimum of a four inch (4") inset.
- b. Rooftop additions (not including dormers) are generally not appropriate for historic buildings. A minimal rooftop access, just large enough to accommodate a stair and that is not visible from a public right-of-way may be appropriate for flat roof historic buildings that are more than 1-story and 9'.
- c. Dormers generally should not be introduced on the front or sides where none originally existed. Rear dormers should be inset from the side walls of the building by a minimum of two feet. The top of a rear dormer should attach below the ridge of the main roof or lower.
- d. When a lot width exceeds 60' or the standard lot width on the block, it may be appropriate to add a side addition to a historic structure. The addition should set back from the face of the historic structure (at or beyond the midpoint of the building) and should be subservient in height, width and massing to the historic structure. Side additions should be narrower than half of the historic building width and exhibit a height of at least 2' shorter than the historic building. To deemphasize a side addition, the roofing form should generally be a hip or side-gable roof form.

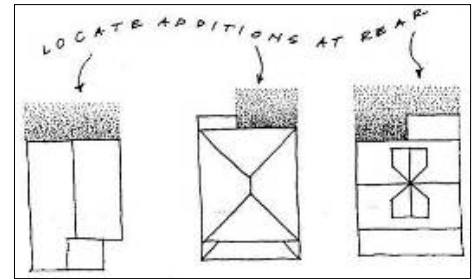

Locate additions at the rear of the primary structure.



V. NEW CONSTRUCTION-ADDITIONS

4. Awnings & Canopies

- a. Historically, awnings were used on commercial buildings for both storefronts and upper façade windows. Occasionally, awnings were found on residential structures.
- b. Awnings should be placed in locations historically used for awnings (within existing window and storefront openings) and should not obstruct transoms, columns, cornices, or other architectural features.
- c. Awnings may be fixed or retractable.
- d. Storefront awnings should project no more than seven feet from the building and should cover no more than one-third of a storefront window display height.
- e. The most appropriate design for awnings is a shed form. The use of shed awnings for upper façade windows is also appropriate. Curved forms are not appropriate, unless there is historical evidence for their use on a building.
- f. Opaque canvas, cotton duck, or similar woven materials are appropriate for awnings. Plastic sheet or vinyl awnings are not appropriate.
- g. Lighting within or immediately beneath an awning is inappropriate.
- h. Canopies may be appropriate at ground-floor level provided they complement a building's architectural style and do not conceal significant architectural features.
- i. Canopies should be constructed of materials compatible with the storefront of the building, such as metal and wood. Also see "New Construction-infill" for information on materials, roofs, utilities/mechanicals, sidewalks/walkways, exterior lighting, appurtenances and other applicable guidance.

VI. SIGNAGE

A. GENERAL PRINCIPLES

Where a sign is proposed to encroach into the public right-of-way an application shall also be made with the Public Works Department. The requirements of the Public Works Department available at their website: www.nashville.gov/Public-Works/Developer-Services.aspx, in addition to the MHZC submittal requirements.

1. For properties in the Rosa L Parks Blvd. Zone signage requirements shall be the same regulations as those that govern the opposite side of the street but are not located in the Germantown HPZO.
2. Buildings with multiple tenants or the possibility of multiple tenants should consider submittal of a sign plan, even if not all signage will be installed immediately, to assure that all tenants have the possibility of signage.
3. The MHZC does not review signage inside a building or sidewalk signage that is removed at the end of each business day.
4. Signs shall be limited to on-premises signs related to the use or business conducted on the same site.
5. A sign shall be brought into compliance with the provisions of these design guidelines if at any time the sign is altered, repaired, restored or rebuilt to the extent that the cost exceeds fifty percent of the estimated replacement cost of the sign (in current dollar value). This does not include a panel change in a non-conforming cabinet sign, which shall be permitted. All permits within any six consecutive calendar months shall be aggregated for purposes of measuring the fifty percent standard. If the alteration or repair is caused by involuntary damage or casualty, the design may be altered or repaired to its pre-damaged condition.
6. A sign may be removed or taken off-site for repair and maintenance. The sign must be returned to the original location within 90 days of removal.

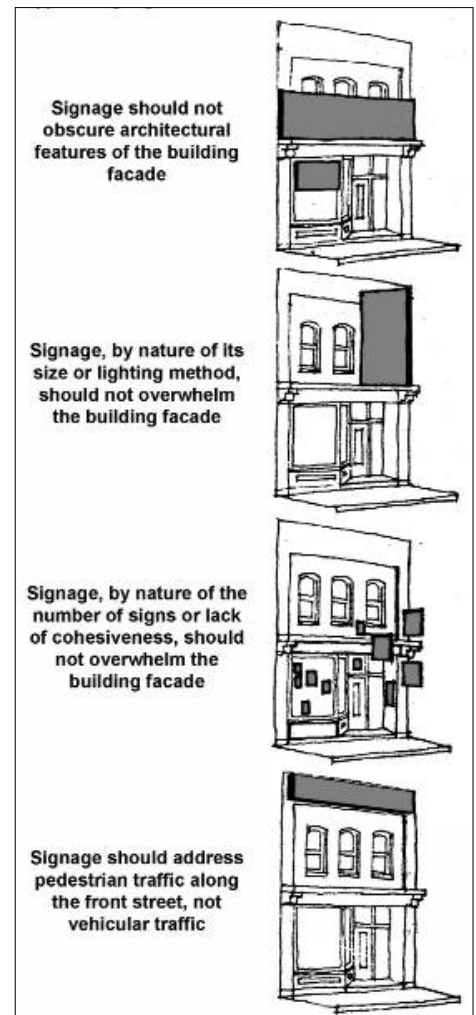

Examples of typical signage mistakes.

VI. SIGNAGE

7. Abandoned, deteriorated, or damaged signs and sign posts shall be removed.
8. Signage not permitted:
 - billboards or general advertising signs
 - marquee type signs for announcements of activities taking place at the location (exceptions: churches, schools, and institutional use)
 - rooftop signs
 - Signs promoting off-site businesses
 - pole-mounted
 - signs that are put in motion by the atmosphere

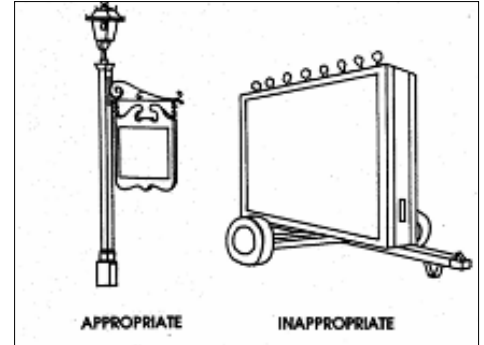

B. DESIGN GUIDELINES

1. Signage Allotment

- a. Maximum square footage per building type, may be divided into multiple signs.
 - House Type: 6 square feet
 - Plex House: 6 square feet
 - House Court: 6 square feet
 - Townhouse: 6 square feet
 - Courtyard: 6 square feet
 - Corner Commercial: 36 square feet
 - Low, mid-rise, mixed use and commercial: 1 square foot of sign area is allowed per linear foot of building façade. Measurements for linear feet shall be at grade, on the front of the building. For corner lots, the same amount of signage allotment as allocated to the front, shall be available for the secondary street-facing side of the building.

2. Location

See additional guidance under “signage type.”

- a. Signage should be placed in locations historically used for signage on the specific building type it is associated with and should not obscure

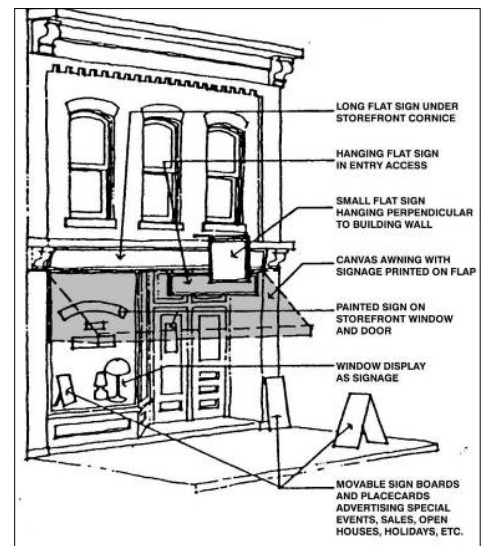

Examples of appropriate types of signage.



For house building types, historic placement is a small wall sign by the door or a shingle sign hanging from the porch beam.

VI. SIGNAGE

transoms, columns, cornices, decorative elements, or key architectural features.

- b. Permanent window painted signs are not reviewed if painted on the inside of the glass.
- c. Signs for multiple tenant occupancies/multiple businesses shall be of similar material and design.
- d. Rooftop signage or signage is not appropriate.

3. Materials

- a. All permanent, on-premises signs shall be constructed of a rigid, weatherable material such as hard plastic, wood, MDO plywood, aluminum, steel, PVC, glass, fiberglass, or Plexiglas. Wood or painted metal are preferable materials. On-premises permanent signs shall not be constructed of nonrigid materials including, but not limited to, vinyl, fabric, canvas, or corrugated plastic. The provisions of this subsection shall not apply to approved, permitted canopies, awnings and porticos.
- b. Painted Signs and Decals (attached to wall with adhesive): All masonry painting and decals, whether for signage, to change the color of the building or structure, or for artwork (murals) shall be reviewed by the MHZC. (Please see section on “walls” for guidance on painting a masonry building.) Signs painted or attached with adhesive directly on a non-contributing building or a historic commercial building type that has already been painted are appropriate if they follow these design criteria:
 - Should only be added to rear or secondary elevations, beyond the first bay of the building, and should not cover transoms, columns, cornices, decorative elements, openings and architectural features, or require the enclosure of openings.

VI. SIGNAGE

- Painted or adhered signage or artwork is not appropriate on main facades.
- The size of a painted sign should be appropriate for the size of the building and should generally not be more than 50 square feet in size.
- Painted signs should serve as a sign for the current occupant(s) and should not advertise off-site businesses or products.
- Generally, painted signage should not have lighting; however, if lighting is necessary, it should be between one and two gooseneck lights or another type of light that can be hidden by an architectural feature. Metallic, fluorescent and day-glow paints are not appropriate.

4. Signage Illumination

- a. External light sources shall be placed close to, and directed onto the sign and shielded to minimize glare into the street, sidewalks or adjacent properties.
- b. Projecting light fixtures used for externally illuminated signs shall be simple and unobtrusive in appearance. They should not obscure the sign.
- c. Buildings and signs may be illuminated by remote light sources, provided that these light sources are shielded to minimize glare to adjacent properties.
- d. Lettering may be internally lit or back-lit in all zones except for the National Register zone. For cabinet signs, the background must be opaque. Only text may be illuminated, and a halo of one inch around text logos may be non-opaque.
- e. The following light sources are prohibited:
 - Exposed neon
 - Signs that flash, blink, revolve, or race
 - Visible bulbs, luminous paints, or plastics
 - Lighting that changes color
 - Signs with changing and moving lighted images



VI. SIGNAGE

C. ADDITIONAL GUIDANCE BY SIGN TYPE

1. Wall Sign

A wall sign is attached flat to, or mounted away from but parallel to the building façade and is appropriate for both commercial and residential building types.

- Wall mounted signs should be located between the first and second stories on commercial building types or near front entrances on residential building types.
- No portion of a wall sign may extend above the roof line or above a parapet wall of a building with a flat roof.
- No portion of a wall sign may extend above the lower eave line of a building with a pitched roof.
- A wall sign cannot cover windows or architectural details.
- A wall sign can be externally or internally illuminated in accordance with the section on Illumination.

2. Awning Sign

Graphics and symbols are painted, sewn or otherwise adhered to the awning material as an integrated part of the awning. The awning itself should follow the design guidelines for “New construction-additions.” Awning signage is appropriate for commercial and residential Building Types.

- A maximum of one sign is allowed per awning face.
- An awning sign may be externally illuminated and may include lighting beneath it, directed towards the sidewalk. The fabric of the awning shall be opaque and not allow lighting to glow through the awning.

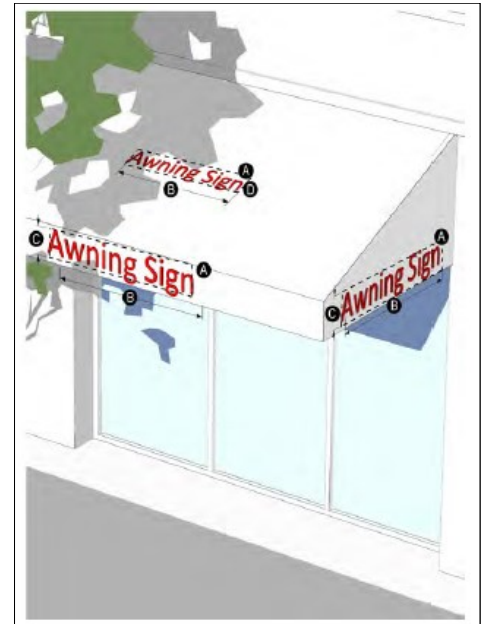

VI. SIGNAGE

c. An awning sign cannot cover architectural details.

3. Canopy Sign

A canopy sign is one that is attached to a canopy.

a. A canopy sign cannot extend beyond the overall length or width of the canopy. However a canopy sign may extend above or below the canopy provided the sign meets all other design standards. A canopy sign is only appropriate on commercial building types.

b. A maximum of one sign per canopy face is permitted.

c. Raceways are permitted for signs extending below or above the canopy.

d. A canopy sign can be externally or internally illuminated in accordance with the Illumination section.

e. Cabinet signs are not permitted as canopy signs.

f. A canopy sign cannot cover architectural details.

See the Awning/Canopy section of the design guidelines for additional information on the design of canopies.

4. Shingle Sign

A shingle sign is a smaller building sign that projects outward, typically at a ninety degree angle, and hangs from a bracket or support that is located over or near a building entrance. Shingle signs are appropriate on residential and commercial building types.

a. Signs shall be located within 8 feet of an active pedestrian building entrance. This distance requirement does not include service entries or entries that primarily remain locked.

b. A corner building is allowed signs on both streets.



VI. SIGNAGE

c. A shingle sign shall be located below the window sills of the second story on a commercial building type or from a front porch rack on a residential building type.

d. A shingle sign shall not be internally illuminated.

e. A shingle sign cannot cover windows or architectural details.

5. Projecting Sign

A projecting sign is a type of building sign that projects outward from the façade, typically at a ninety degree angle. Projecting signs are typically, but not always, vertically oriented and generally mounted above the first floor. They are only appropriate on commercial building types.

a. Projecting signs shall be limited to one per property for each street frontage.

b. The size and projection of a projecting signs should be proportional to the building and not exceed a maximum of 16 square feet (one side) and a projection of more than six feet from the building face. Maximum thickness should be limited to one foot.

c. A projecting sign is generally only appropriate for buildings taller than two stories.

d. A projecting sign may be erected on a building corner when the building corner adjoins the intersection of two streets.

e. A projecting sign shall be located below the windows sills of the third story.

f. The top of a projecting sign shall not extend above the building eave or top of parapet.



Free standing signs of limited size are recommended. If signs must be placed on buildings, a small panel at the entrance is recommended.

VI. SIGNAGE

- g. A projecting sign can be externally or internally illuminated in accordance with the Illumination design guidelines.
- h. A projecting sign cannot cover windows or architectural details.

6. Monument Sign

A monument sign is a ground sign that is attached along its entire length to a continuous pedestal. Monument signs are appropriate on commercial and residential building types.

- a. Monument and freestanding signs shall be permitted only when a building sits more than 15 feet from a public street.
- b. Monument signs shall be limited to a height of 4', a maximum thickness of 12", and a maximum square footage of 12'.
- c. A monument sign must be set back at least 5 feet from the front property line.

VII. DEMOLITION

A. GENERAL PRINCIPLES

Demolition of a building, or major portion of a building that contributes historically or architecturally to the character and significance of the district is not appropriate.

B. DESIGN GUIDELINES

1. Demolition is Not Appropriate

- a. If a building, or major portion of a building contributes to the architectural or historical or character of the district.
- b. Or, if a building, or major portion of a building is of such old or unusual or uncommon design and materials that it could not be reproduced or be reproduced without great difficulty and expense.

2. Demolition is Appropriate

- a. If a building, or major portion of a building does not contribute to the architectural or historical character or significance of the district; or,
- b. If a building, or major portion of a building has irretrievably lost its physical integrity to the extent that it no longer contributes to the district's architectural or historical character or significance; or,
- c. If the denial of the demolition will result in an economic hardship on the applicant as determined by the MHZC in accordance with section 17.40.420 (Historic Zoning Regulations), Metropolitan Comprehensive Zoning Ordinance.



Above: Prior to demolition.

Below: After demolition.



VIII. RELOCATION

A. GENERAL PRINCIPLES

1. Generally, moving a historic building from its original site is not appropriate.
2. When relocation is appropriate, a building should be moved carefully in order to retain the integrity of original architectural details and materials.

B. DESIGN GUIDELINES

In some cases, moving a residential building to a new foundation also requires approval of the Planning Commission, according to 13-3-502 of the Tennessee Code Annotated. Please contact the Planning Department for additional information.



602 Madison Street house prepared to be moved to Hope Gardens.

1. Moving a building into the district is appropriate if the building will be compatible with the historic buildings surrounding the new location in terms of height, scale, setback and rhythm of spacing, materials, texture, details, material color, roof shape, orientation, proportion, and rhythm of openings.
2. Moving a building out of the district is not appropriate unless:
 - a. The building does not contribute to the architectural or historical character or significance of the district; or,
 - b. The building has irretrievably lost its physical integrity to the extent that it no longer contributes to the district's architectural or historical or significance; or,
 - c. The building's architectural and historical integrity in its original location is eminently threatened.
3. Moving a building from one location to another within the district is not appropriate unless:
 - a. The building will be compatible with the historic buildings surrounding the new location in terms of height, scale, setback and rhythm of spacing, materials, texture, details, material color, roof shape, orientation, and proportion and rhythm of openings; and
 - b. The building's architectural and historical integrity in its original location is eminently threatened.



VIII. DEFINITIONS

Addition: 1. New construction that increases the habitable space of an existing structure, and is capable of being heated or cooled. 2. An alteration that changes the exterior height of any portion of an existing building, such as skylights, covered porches, covered decks, carports and porte cocheres.

Adjacent: Close proximity, surrounding

Alteration: A replacement or change in building's or a site's material or design; the addition or elimination of any architectural element of a building; a repair that reconstructs any part of an existing building; construction of, or change to, an appurtenance.

Appropriate: Suitable for, or compatible with a property or district, based on accepted standards and techniques for historic preservation.

Appurtenances: Fences, walls, paving, streetlights, curbs, gravel, signs, satellite dishes, fountains, mailboxes, and other accessory or adjunct permanent built features related to a building or streetscape and those features or structures installed for more than 30 days in a calendar year.

Bulk Standards: Regulations and controls that establish the maximum size of buildings and structures on a lot and the buildable area within which the building can be located, including coverage, setbacks, height, impervious surface ratio, floor area ratio and yard requirements

Conjectural Features: A feature that is not original and not known to have historically been on the building or site in question, as evidenced by photographs, maps or construction.

Contributory Status: Buildings constructed during the period of significance for the district and that have physical integrity are considered as "contributing" to the historic character of the district. They may or may not be significant in their own right. Buildings that do not contribute to the historic character of the district are called non-contributing. Contributory status and period of significance can change over time as new information becomes available and as a districts ages. The first factor to consider is the building's age. Was the building constructed during the period of significance of the district? Is that period of significance still valid? The second consideration is to analyze changes that have taken place over time. Does the building retain the majority of its character defining features and form? If the building retains its original form, despite numerous changes, it is likely still considered contributing.

DEFINITIONS, continued

Decal Signage: *A design prepared on special paper for transfer onto a surface such as masonry, wood or metal and is often adhered with some type of glue.*

Demolition: *Tearing down a building or structure, or a portion thereof.*

Edging: *Stone or concrete used to delineate a yard from the sidewalk that was often used as a base for metal fencing.*

Elevation: *A scaled drawing that illustrates the view of a facade of a building.*

Embossed Grain: *The embossed pattern pressed into a manufactured material, simulating wood grain or texture.*

Facade: *An exterior face of a building.*

Historic: *A structure or site, usually constructed more than fifty years ago that possesses historical or architectural significance based on the criteria for listing in the National Register of Historic Places.*

Mural: *A piece of artwork that does not provide advertising and that is adhered onto an exterior façade. Typically murals are painted but may also be paper, cloth, vinyl, or plastic adhered to a wall.*

Non-Historic: *A structure or site, usually constructed within the last fifty years that does not possess historical or architectural significance based on the criteria for listing in the National Register of Historic Places.*

Orientation: *The directional expression of the front facade of a building, e.g., facing the street, facing north.*

Period of Significance: *According to the National Park Service, that administers the National Register program, “period of significance refers to the span of time during which significant events and activities occurred. Events and associations with historic properties are finite; most properties have a clearly definable period of significance.”*

Preservation Permit: *A legal document issued by the Metropolitan Historic Zoning Commission confirming review and approval of work to be done on property within the boundaries of an historic or neighborhood conservation zoning overlay district. A preservation permit is required before obtaining a building permit.*

Public Right-of-Way: *Publicly owned and maintained streets, alleys, greenways, and walkways.*

VIII. DEFINITIONS, continued

Public Space: Any area owned, leased, or for which there is held an easement by a governmental entity, or an area that is required to be open to the public.

Raceways: A three-sided rectangular box that functions as a mounting mechanism, and electronic component enclosure for a wall mounted sign.

Reconstruction: Construction of an accurate replica of a historic building or portion thereof, based on physical, pictorial or documentary evidence.

Relocation: Moving a building from one site to another.

Shall: What must happen.

Should: What must happen unless circumstances demonstrate why an alternative is more appropriate.

Wayfinding Signage: Signage that provides guidance to people through a physical environment and enhances their understanding and experience of the space. It does not seek to promote or advertise.



Example of sign with exposed raceway.



Example of wayfinding signage.

Sunnyside in Sevier Park
1113 Kirkwood Avenue
Nashville, TN 37204
Phone: 615-862-7970

The Metropolitan Historic Zoning Commission reviews applications to create new historic overlay districts and reviews and approves preservation permits in historic and conservation districts for new construction, alterations, additions, repair and demolition. For design guidelines, permit applications, and meeting information, visit us at www.nashville.gov/mhc.

**WE ARE ON THE
WEB AT
[WWW.NASHVILLE.
GOV/MHC](http://WWW.NASHVILLE.GOV/MHC)**



The Metro Historical Commission does not discriminate on the basis of race, color, national origin, gender, gender identity, sexual orientation, age, religion, creed or disability in access to, or operation of its programs, services, activities or in its hiring or employment practices. **ADA inquiries should be forwarded to:** Yvonne Ogren, Metro Historical Commission ADA Compliance Coordinator, 3000 Granny White Pike, Nashville, TN 37204, (615) 862-7970. **Title VI inquiries should be forwarded to:** Ms. Shirley Sims-Saldana, Title VI Coordinator, Human Relations, 800 Second Avenue, South, 4th floor, Nashville, TN 37210, (615) 880-3391. **Contact Department of Human Resources for all employment related inquiries** at (615) 862-6640.