

NEIGHBORHOOD CONSERVATION ZONING DESIGN GUIDELINES FOR TURN-OF-THE-20TH CENTURY DISTRICTS: PART I



METROPOLITAN HISTORIC ZONING COMMISSION

Metropolitan Government of
Nashville and Davidson County

Sunnyside in Sevier Park
1113 Kirkwood Avenue
Nashville, Tennessee 37204
615-862-7970

www.nashville.gov/mhc
historicalcommission@nashville.gov

April 21, 2021
with effective date of May 20, 2021
Italicized information revised 2024

INSIDE

<i>Historic Zoning Overlay</i>	2
<i>What are the Design Guidelines</i>	3
<i>Purpose of the Design Guidelines</i>	4
<i>Secretary of Interior Standards</i>	5
<i>Design Guideline Principles</i>	7
<i>Demolition</i>	10
<i>Materials</i>	13
<i>New Construction-Infill</i>	16
<i>New Construction-Additions</i>	23
<i>New Construction-Outbuildings</i>	31
<i>Relocation</i>	38
<i>Definitions</i>	39



I. INTRODUCTION

A. THE NEIGHBORHOOD CONSERVATION ZONING OVERLAY

Please also see *MHZC Hand Book*.

Neighborhoods in more than two thousand towns and cities in the United States use historic zoning as a tool to protect their unique architectural characters. There are quantifiable reasons for historic zoning: it gives neighborhoods greater control over development; it stabilizes property values; it decreases the risk of investing in one’s building; it promotes heritage tourism; it protects viable urban housing stock; and it preserves natural resources by conserving building materials. There are less quantifiable, but equally important, reasons for historic zoning—it protects our past for future generations, it nurtures a sense of community, and it provides a sense of place.

Historic zoning overlays are **locally** designated and administered by the Metropolitan Historic Zoning Commission (MHZC), an agency of the Metropolitan Government of Nashville and Davidson County. Historic zoning overlays are applied in addition to the base or land-use zoning of an area. *Historic zoning overlays do not impact use.*

Like the National Register of Historic Places, historic zoning honors an area’s historical significance. There are five types of historic zoning overlays: historic preservation, neighborhood conservation, historic bed and breakfast, historic landmarks, and historic landmark interiors.

In neighborhood conservation and historic bed and breakfast homestay zoning overlays, certain exterior work on buildings—new construction, additions, demolition, and relocation—is reviewed to ensure that the neighborhood’s historic character is preserved. In addition to the projects reviewed in neighborhood conservation and historic bed and breakfast zoning overlays, historic preservation and historic landmark overlays also review exterior alterations to existing buildings - like replacing windows, altering storefronts, or painting brick. Overlays with historic preservation or historic landmark zoning are not more historically significant than those with neighborhood conservation zoning; rather, the MHZC, in conjunction with neighborhood input and local council member direction, determined that these overlays are most compatible with the goals of the neighborhood and the MHZC.

WHAT IS REVIEWED:

IN A HISTORIC LANDMARK OVERLAY

- *New construction (primary and secondary structures)*
- *Additions – increased footprint, height, or building envelope of an existing structure*
- *Demolition (in-whole or in-part)*
- *Relocation of structures*
- *Construction of appurtenances (with the exception of portable storage buildings less than 100 square feet)*
- *Signage*
- *Repairs and alterations to existing structures*
- *Setback determinations*

IN A HISTORIC LANDMARK INTERIORS

- *Alterations within certain interior spaces identified at the time of designation*

IN A HISTORIC PRESERVATION OVERLAY

- *New construction (primary and secondary structures)*
- *Additions – increased footprint, height, or building envelope of an existing structure*
- *Demolition (in whole or in-part)*
- *Relocation of structures*
- *Construction of appurtenances (with the exception of portable storage buildings less than 100 square feet)*
- *Signage*
- *Repairs and alterations to existing structures*
- *Setback determinations*



I. INTRODUCTION

B. WHAT ARE THE DESIGN GUIDELINES?

The Metropolitan Historic Zoning Commission (MHZC) is the architectural review board that reviews applications for work on properties within historic zoning overlay districts. Its nine members, appointed by the mayor, include representatives from historic zoning overlays, the Metropolitan Planning Commission, the Metropolitan Historical Commission, architect(s), and others. Design review is administered according to a set of design guidelines. The guidelines are criteria and standards, developed jointly by the MHZC and the residents of the neighborhood, which are used in determining the architectural compatibility of proposed projects. The guidelines provide direction for project applicants and ensure that the decisions of the MHZC are not arbitrary or based on anyone's personal taste.

The guidelines protect the neighborhood from new construction or additions not in character with the neighborhood and from the loss of architecturally or historically important buildings.

By state and local legislation, design guidelines for historic overlays must be in accordance with the *Secretary of the Interior's Standards for the Treatment of Historic Properties*—criteria developed by the National Park Service and used by private and public preservation organizations throughout the country. (Please see I.D.)

The Neighborhood Conservation Zoning Overlays (NCZO), included in these design guidelines, have the same set of design guidelines (Part I) and chapters specific to each district (Part II). Where the general NCZO guidelines and the district specific chapters conflict, the district specific chapters shall prevail.

The italicized sections of the design guidelines contain interpretive information that is meant to make the guidelines easier to understand and memorialize precedent-setting decisions.

Illustrations are intended to provide example buildings and circumstances.

It is important to remember that every building and site is different, and what may be appropriate for one building or site may not be appropriate for another.

IN A NEIGHBORHOOD CONSERVATION OVERLAY (NCZO) (also B&B Homestays)

- *New construction (primary and secondary structures)*
- *Additions – increased footprint, height or building envelope of an existing structure*
- *Demolition (in-whole or in-part)*
- *Relocation of structures*
- *Setback determinations*

WHAT IS NOT REVIEWED

- *Temporary (30 days or fewer) appurtenances, such as:*
 - Real estate, opening soon, special event, and construction signage*
 - Construction related fencing and structures*
 - Special event related structures*
- *Painting of wood*



I. INTRODUCTION

C. PURPOSE OF THE DESIGN GUIDELINES

Within Title 17 of the Metro Codes of Ordinances, “historic zoning” is used as the general term for Nashville’s five types of zoning overlay districts applicable to historic properties: historic preservation, neighborhood conservation, historic bed and breakfast, historic landmark, and historic landmark interiors.

1. Design guidelines are criteria and standards which the Metropolitan Historic Zoning Commission must consider in determining the appropriateness of proposed work within a neighborhood conservation zoning district. Appropriateness of work must be determined in order to accomplish the goals of historic and neighborhood conservation zoning, as outlined in Article III, Chapter 17.36 (Historic Zoning Regulations), Metropolitan Comprehensive Zoning Ordinance:
 - a. To preserve and protect the historical and/or architectural value of buildings or other structures;
 - b. To regulate exterior design, arrangement, texture, and materials proposed to be used within the historic district to ensure compatibility;
 - c. To create an aesthetic appearance which complements the historic buildings or other structures;
 - d. To foster civic beauty;
 - e. To strengthen the local economy; and
 - f. To promote the use of historic districts for the education, pleasure, and welfare of the present and future citizens of Nashville and Davidson County.



I. INTRODUCTION

D. SECRETARY OF INTERIOR STANDARDS

By Tennessee state law, all design guidelines for historic overlays must comply with the Historic Preservation Act of 1966, as amended. The section of the Act which deals specifically with rehabilitation of historic properties is the Secretary of the Interior's Standards for Treatment of Historic Properties. The Standards are a series of concepts about maintaining, repairing, and replacing historic materials, as well as designing new construction or making alterations. When the design guidelines do not provide guidance for a specific request, the Standards shall be relied upon.

- 1. A property will be used as it was historically or be given a new use that requires minimal change to its distinctive materials, features, spaces and spatial relationships.*
- 2. The historic character of a property will be retained and preserved. The removal of distinctive materials or alteration of features, spaces and spatial relationships that characterize a property will be avoided.*
- 3. Each property will be recognized as a physical record of its time, place and use. Changes that create a false sense of historical development, such as adding conjectural features or elements from other historic properties, will not be undertaken.*
- 4. Changes to a property that have acquired historic significance in their own right will be retained and preserved.*
- 5. Distinctive materials, features, finishes and construction techniques or examples of craftsmanship that characterize a property will be preserved.*
- 6. Deteriorated historic features will be repaired rather than replaced. Where the severity of deterioration requires replacement of a distinctive feature, the new feature will match the old in design, color, texture and, where possible, materials. Replacement of missing features will be substantiated by documentary and physical evidence.*
- 7. Chemical or physical treatments, if appropriate, will be undertaken using the gentlest means possible. Treatments that cause damage to historic materials will not be used.*
- 8. Archeological resources will be protected and preserved in place. If such resources must be disturbed, mitigation measures will be undertaken.*
- 9. New additions, exterior alterations or related new construction will not destroy historic*

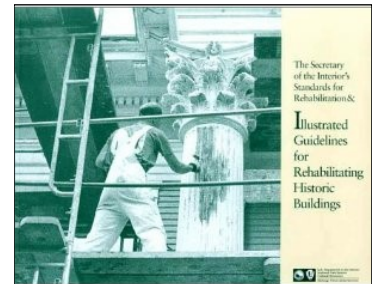

The full set of [Secretary of Interior Standards](#) may be found online.



I. INTRODUCTION

materials, features and spatial relationships that characterize the property. The new work will be differentiated from the old and will be compatible with the historic materials, features, size, scale and proportion, and massing to protect the integrity of the property and its environment.

- 10. New additions and adjacent or related new construction will be undertaken in such a manner that, if removed in the future, the essential form and integrity of the historic property and its environment would be unimpaired.*



II. DESIGN GUIDELINE PRINCIPLES

- A. Italicized sections of the guidelines contain interpretive information that is meant to make the guidelines easier to understand and to communicate how the commission has interpreted the guidelines; they are not part of the guidelines. Illustrations are intended only to provide example buildings and circumstances. It is important to remember that every building and site is different, and what may be appropriate for one building or site may not be appropriate for another.
- B. The design guidelines for neighborhood conservation zoning overlays consist of two parts. Part I includes basic design guidelines that apply to all neighborhood conservation zoning overlay districts, listed in Part II. Part II includes chapters specific to each overlay, as well as maps and short histories. Both parts should be considered when planning a project. When Part I of the design guidelines conflicts with a district-specific design guideline in Part II, the district-specific design guideline shall prevail.
- C. These guidelines shall apply to the exteriors of buildings, new construction in-whole or in-part, demolition in-whole or in-part, and moving a building.
- D. The following actions that do not require the removal of a historic feature(s) may not require a Preservation Permit. (These actions may still require a Building Permit. Please check with Codes Department before proceeding with work.)

See additional guidance in [Part II of the Consolidated Design Guidelines](#), especially for the following districts

- Bowling House District*
- Cherokee Park*
- Eastdale*
- Edgehill*
- Greenwood*
- Inglewood Place*
- Kenner Manor*
- Lockeland Springs-East End*
- Richland-West End*
- Salemtown*
- Waverly-Belmont*
- Woodlawn West*

Site

- Fences and walls that are not attached to a structure. (See [Building a Fence in Davidson County](#))
- Structures without a roof such as some playground equipment
- Uncovered patios that are flush with existing grade and do not extend into setbacks
- Yard art (structure without a roof or foundation)
- All plants, including trees, bushes, flowers, etc. (Structures to accommodate living elements may require review.)
- In-ground pools that do not include above-ground decking or structures
- Resurfacing existing driveways, walkways, or parking pads
- Uncovered accessibility ramps



II. DESIGN GUIDELINE PRINCIPLES

Buildings

- New free-standing buildings and structures that are less than 100 square feet, do not have a permanent foundation, and are located to the rear of the property.
 - Garden or play structures that do not have a permanent foundation, do not have sides, and are less than 200 square feet.
 - Screening in of porches, when the screening does not require the removal of porch posts and does not require additional framing.
 - Uncovered rear and side decks that are close to grade (does not create usable space underneath) and do not extend into setbacks.
 - Replacement of window sashes and doors that maintains historic casings and the opening's dimensions and locations.
 - Hoods over entrances that do not require posts, do not extend wider than two feet beyond each side of the door trim, and do not extend more than three feet deep.
 - Installation of fabric window and door awnings that do not extend wider than two feet beyond each side of the window or door trim, and do not extend more than three feet deep.
 - Replacement roofing materials (not including roof framing)
 - Paint color
 - Replacement railings or posts on existing porches
 - Roof color
- E. The public facades—front- and street-facing sides—of proposals for new buildings shall be more carefully reviewed than other facades.
- F. New buildings do not need to imitate past architectural styles but should be similar to historic forms and massings found in the district. New buildings inspired by historic styles and forms, but identifiable as new construction, are appropriate.
- G. The size of a new building and its mass in relation to open spaces shall be compatible, by not contrasting greatly, with surrounding historic buildings.
- H. Reconstruction may be appropriate when it accurately reproduces a no-longer existing building on its original site, if the building (1) would have contributed to the historic and architectural character of the area; (2) will be compatible in terms of style, height, scale, massing, and materials with the buildings



Example of a small storage building without a permanent foundation.



II. DESIGN GUIDELINE PRINCIPLES

immediately surrounding it; and (3) is accurately based on documentary, physical, or pictorial evidence.

- I. Some districts have had continuous construction over a wide period of time that has resulted in a variety of building types and styles, while others have a more consistent development pattern. New buildings should continue the tradition of the individual neighborhood while complementing and being visually compatible with surrounding historic buildings.



III. DEMOLITION

A. PRINCIPLE

1. The primary purpose of neighborhood conservation zoning overlays is to prevent demolition of historic buildings and their character-defining features.
2. The demolition of a building or major portion of a building, which contributes historically, culturally, or architecturally to the character and significance of the district, is not appropriate.
3. The historic character-defining features of a historic building should not be altered, removed, or destroyed.
4. Replacement windows and doors that do not change the dimensions and location of the openings is not considered partial-demolition and so is not reviewed. Replacement of historic casings for openings is not appropriate. Alteration of the location and dimensions of window and door opening is partial-demolition and so reviewed.
5. Replacement roofing material that does not require the removal of framing material and roofing details such as trim, or roofing features such as chimneys is not considered partial-demolition and so is not reviewed.
6. The removal of a building's primary cladding material is considered partial-demolition because removal can weaken the structural integrity of most buildings. Replacement of secondary cladding material such as siding in a gable field or on dormer is not reviewed.



III. DEMOLITION

B. GUIDELINES

1. Partial-demolition of a structure

- a. Character-defining features of historic buildings shall be retained. Partial-demolition of historic buildings is appropriate if the feature to be removed is not a character-defining feature. Examples of non character-defining features are features that have lost historic integrity or that were added in recent years.
- b. Replacement of historic materials or features may be necessary in the case of extreme deterioration. In those cases, replacement materials and features should match the historic material and feature in terms of design, location, and dimensions. If the original is not known, it shall be similar to common historic examples on buildings of a similar style and form found in the neighborhood. Substitute materials may be appropriate if the material has the same dimensions, texture, design, and workability as the historic material. For instance, smooth-faced fiber-cement lap siding is a common substitute material for wood lap siding.
- c. Historic cladding shall be retained. It is appropriate to remove cladding installed over historic cladding material and repair the historic cladding. Lap siding installed over, or to replace historic masonry, or a masonry veneer installed over, or to replace historic lap siding is not appropriate. When it is appropriate to replace siding, the casings of openings should be retained. And the new siding shall replicate the reveal and dimensions of the historic siding.
- d. Historic window and door dimensions and locations should be retained. Limited changes to window and door openings may be appropriate on the rear or side facades, beyond the midpoint of the house, so long as the new window and door pattern meets the design guidelines for “proportion and rhythm of openings.”
- e. Historic building wall dimensions, exterior cladding, and locations shall be retained. Generally, removal of the rear wall for an addition may be appropriate if the two rear corners are maintained.



III. DEMOLITION

- f. Partial-demolition of non-contributing buildings is appropriate if demolition does not result in a form or condition that would not meet the design guidelines for “new construction” or if partial-demolition brings the existing building closer into compliance with the design guidelines for new construction.

2. Full-demolition of a structure

- a. Historic buildings shall be retained unless the denial of the demolition will result in an economic hardship, as determined by the MHZC in accordance with section 17.40.420 (Historic Zoning Regulations), Metropolitan Comprehensive Zoning Ordinance.
- b. Full-demolition of non-contributing buildings is appropriate as they do not contribute to the historic character of the district.



IV. MATERIALS

MATERIALS, TEXTURE, DETAILS & MATERIAL COLOR

Please see “Partial Demolition” for replacement siding.

A. Specific materials are italicized so that the list can be revised as more materials become available and as the quality and workability of existing materials improves. Materials listed are to provide general guidance to applicants based on the Commission’s past decisions. Applicants are always welcome to propose new materials not listed as “appropriate” or re-propose materials listed as “inappropriate.”

B. The texture, details, and dimensions of new materials for replacement or new construction shall be visually compatible, by not contrasting greatly, with surrounding historic buildings. Replacement materials should mimic historic materials in texture, dimensions, and workability. Materials that create a false version of a historic material are not appropriate. For instance, a “wood-grain” fiber-cement lap siding creates a texture that did not exist historically, as wood cladding historically had a smooth finish.

1. Paint color and roof color are not reviewed. The texture and dimensions of masonry is reviewed. *It is recommended that if multiple colors are used for a roof that they be used to create a pattern, as seen historically, rather than creating a “speckled” or random design.*

2. *INAPPROPRIATE materials include:*

Foundations

- *Stone veneer without mortar*
- *Smooth concrete block without a parge coating*

Parging is approximately a 1/2 to 3/4 -inch or thicker coating of mortar trowelled onto the exterior of the concrete masonry blocks.

Cladding

- *Synthetic sidings such as vinyl, aluminum, permastone and E.F.I.S.*
- *T-1-11- type building panels*
- *Stud wall lumber*
- *Embossed wood grain*
- *Unpainted or unstained wood*



IV. MATERIALS

Chimneys

- *Fiber cement panels*
- *Lap siding*

Roofing

- *Corrugated metal*
- *Snap-lock standing seam metal with big seams*
- *Metal made to look like a traditional materials such as wood shingles, slate or clay/terra cotta*

Windows

- *Brass comes on leaded or stained glass windows.*

3. APPROPRIATE materials include:

Foundations

- *Continuous or piers of pre-cast stone, split-face concrete block, parge coated concrete block, or brick as long as the primary cladding is not the same material as the foundation*
- *Foundation lines should be visually distinct from the predominant exterior wall material. This is typically accomplished with a change in material at the floor line.*

Cladding

- *Smooth-finished cement fiberboard or smooth-finished wood lap sidings are both appropriate. The siding should not be stamped or embossed and the reveal should not exceed 7". Wider reveals may be appropriate if a wider reveal meets the immediate historic context and if the building is only one-story with mitered corners rather than a corner board, to be in keeping with typical conditions of historic wide siding reveals.*
- *Shingle siding is only appropriate as an accent material, an upper level, or a feature such as a bay.*
- *Fiber-cement or wood panels, board-and-batten, and half-timbering are only appropriate as accent materials such as cladding for a bay, a gable field or an upper level.*
- *When different cladding materials are used on one building, it is most appropriate to have the change happen at floor lines.*
- *Masonry cladding should have the dimensions, textures, and mortar tooling of like historic examples.*
- *Four inch (4") nominal corner boards are required at the face of each exposed corner*



IV. MATERIALS

of a frame building, unless the lap siding is mitered.

- *All wood, or materials to substitute for wood, should be milled and painted, with the exception of shingles which could be painted or stained.*

Chimneys

- *Masonry or stucco is appropriate for chimneys.*

Roofing

- *Asphalt and architectural shingles, slate and slate substitutes, and metal are appropriate roofing materials. Clay tile, or clay tile substitutes may be appropriate in areas where this a common historic roofing material.*
- *Clay tile ridges are appropriate.*
- *Types of appropriate metal roofing include 5-V, low-profile snap-lock, rolled standing seam*

Trim & Architectural Features

- *All wood or materials to substitute for wood should be milled and painted.*
- *Composite materials are appropriate for trim and decking*

C. Windows with single-light sashes are appropriate for new construction. If using multi-light sashes, muntins should be fully simulated and bonded to the glass, and exhibit an interior bar, exterior bar, as well as a spacer between glass panes.

D. Four inch (nominal) casings are required around doors, windows, and vents on non-masonry buildings. Trim should be thick enough to extend beyond the clapboard. Paired and ribbons of multiple single- or double-hung windows should have a four inch to six inch (4" to 6") mullion in between each window.

E. Brick moulding is required around doors, windows, and vents within masonry walls but is not appropriate on non-masonry buildings.



V. NEW CONSTRUCTION-INFILL

A. MASSING & SCALE

1. The height of the foundation wall, porch roof(s), walls, and ridges, and the width of a new building should be compatible with surrounding historic buildings of the same building type and on same the block face . Where there are block faces with little historic context, the adjoining blocks may be used.

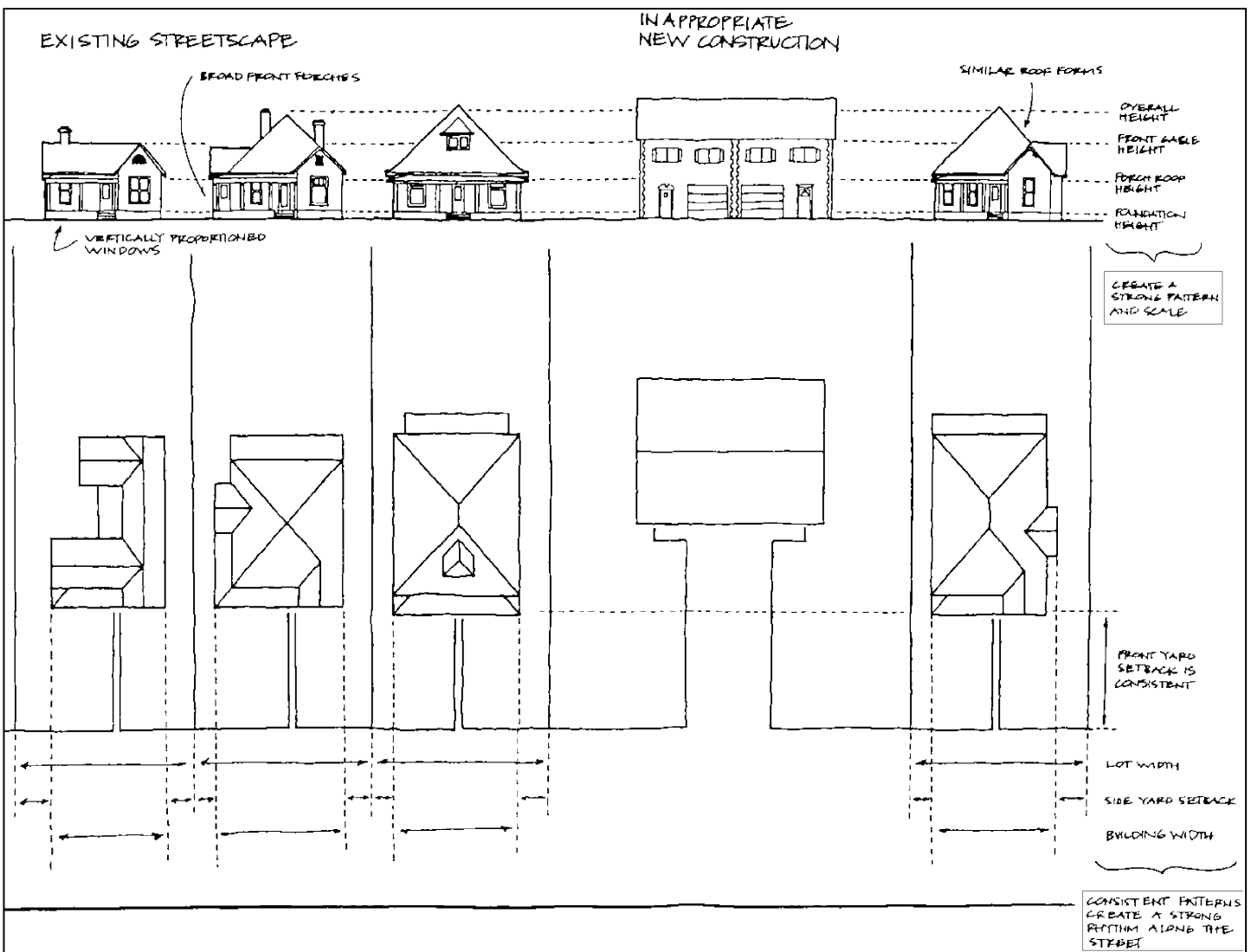

The infill (4th building from the left) is inappropriate for multiple reasons. It does not meet the established rhythm of the street which is created by side setbacks and the widths of the buildings. It is taller and wider than the established context. The overall form is not consistent with the historic buildings in that it is a two-story form with a side-gable roof in an area where the context is one and one-half stories with gabled ell and pyramidal roof forms. Front-loading garages are also not found in this context. The windows have a horizontal proportion rather than the vertical proportion found on the historic buildings. The front yard setback is not consistent with the setbacks established by the historic buildings.



V. NEW CONSTRUCTION-INFILL

B. FORM

1. The most appropriate building and roof forms for new construction are ones that are similar to historic buildings on the block face and buildings that are typical for the overall district. Considerations are the general form and orientation of the main massing of the building and roof pitches, shape, and orientation.
2. In most areas, residential roof pitches of the main form of a building are between 6/12 -12/12. Porches generally had lower pitches or were flat. In some rare cases, flat roof forms may be appropriate. In those instances, the flat roof should not include additional construction such as railings, coverings like pergolas and tents, or stair/elevator towers.
3. Dormers should be fully located on the roof; wall dormers and recessed dormers are generally not appropriate on the front and side facades, as they are not common or not found historically in most districts. The dimensions and forms of dormers visible from the street should be compatible with dormers found historically in the district. Generally, this can be accomplished with the following:
 - a. The number of dormers and their location and size should be appropriate to the style and design of the building. Often the width of roof dormers relate to the openings below. The symmetry, or lack of symmetry within a building's design, should be used as a guide when placing dormers.
 - b. Dormers should not be located on secondary roof planes.
 - c. Eave depth on a dormer should match main roof form's eave depth or be less.
 - d. The roof form of the dormer should match the main roof form of the building or be appropriate for the style.
 - e. The roof pitch of the dormer should generally match the roof pitch of the main roof form of the building.



This building is an example of a one and one half story building. A "half-story" means that the upper level space is fully under the roof and often evidenced by a dormer or window in the gable field. This building has a gabled roof dormer and windows in the side gable field on the 1/2 level.



V. NEW CONSTRUCTION-INFILL

- f. The side walls of the dormer should be inset at least two feet (2') from the side walls of the building or adjacent valley. A dormer wall should not connect with the side of a gable.
- g. The front wall of the dormer should be setback a minimum of two feet (2') from the wall below. (These minimum insets will likely be greater than two feet (2') when following the guidelines for appropriate scale.)
- h. Dormers should generally be fully glazed and aprons below the window should be minimal.
- i. The exterior material cladding of side dormers should match the primary or secondary material of the main building.



A porte-cochere is a covered entrance wide enough for a vehicle to pass through, typically opening into a courtyard. They are usually attached to the side of a building, one-story in height, and no more than 10'-12' wide.

4. New buildings should have a primary entrance oriented towards (facing) the street. In most districts, a primary entrance is defined by a projecting or recessed porch. If the historic context supports such, decorative entrances, hoods above entrances, covered stoops, and vestibule entrances could be appropriate substitutions for a porch.

- a. Generally, porches should be a minimum of six feet deep (6') with a visible porch beam that is 18"-36" in height and with posts that include bases and capitals.

5. Porte-cocheres are only appropriate where they are typical of historic forms found in the district and should only be added to new buildings that have a similar form to those that historically had porte-cocheres.

6. Some properties are zoned for two residential units on one lot. On such lots that meet all the qualifications for two units, the two units should be fully attached, with a single mass (in what looks like one building) with one or two front doors and meet all the requirements for infill. Detached infill duplexes may be appropriate in the following instances:

- a. The second unit follows the design guidelines for an outbuilding.
- b. There is not enough square footage to legally subdivide the lot, but there is enough street frontage and depth to the lot to accommodate two single-family

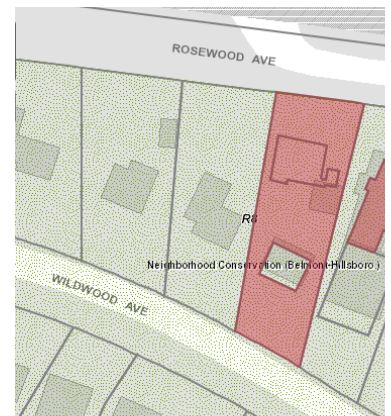

A lot that has frontage on two or more streets that do not intersect at a point abutting the property. A corner lot is not a "double-frontage" lot. 1817 Rosewood is an example of a double frontage lot with frontage on Wildwood and Rosewood Avenues.



V. NEW CONSTRUCTION-INFILL

- dwelling in a manner that meets the design guidelines and historic context and is more appropriate for the context than a single building.
- c. The lot has double frontage and is deep enough to accommodate two buildings and associated parking in a manner that meets the design guidelines and historic context.
 - d. An existing, non-contributing building sits so far back on the lot that a building may be constructed in front of it in a manner that better meets the design guidelines than existing conditions. It is not appropriate to add a new house in front a contributing house.
7. Building types generally should be consistent with the types in the immediate vicinity, no matter the actual use or zoning of the site. For instance, a lot zoned commercially but located within an area of residential building types should be similar in form to the residential building types in the immediate vicinity.
8. Roof decks are not appropriate on the front or side of infill but may be appropriate on the rear if the deck is surrounded on all sides by an appropriately-pitched roof.

C. SITING, SETBACK , ORIENTATION & RHYTHM OF SPACING

- 1. In most residential districts, lots had a primary building facing the street. Any additional buildings on the lot were typically secondary structures that were subordinate in size to the primary building and located in the rear yard. New development should follow this pattern.
- 2. The setback from front- and side-yard property lines established by adjacent historic buildings should be maintained.
- 3. There should be a minimum of 20' between primary buildings and outbuildings.
- 4. The Commission has the ability to determine appropriate building setbacks of the required underlying base zoning for new construction, additions, and accessory structures (ordinance no. 17.40.410).

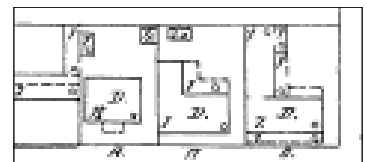

Bulk standards established by the zoning ordinance didn't exist when our historic districts developed so the Commission looks more to the historic context to determine appropriate setbacks.



V. NEW CONSTRUCTION-INFILL

- a. Front setbacks generally should be the average between the historic front setbacks established on either side of the proposed infill. If the lot has non-contributing or vacant lots on either side, the front setbacks of nearby historic buildings may be considered.
 - b. Side setbacks should maintain the dominant rhythm along a street established by building widths and spaces between buildings. Infill buildings should maintain that rhythm even when lots are subdivided.
 - c. Rear setbacks are determined based on a combination of bulk standards and an appropriately-scaled building for the district.
 - d. When a building is unable to meet bulk standard setback requirements, appropriate setbacks will be determined based on:
 - The existing setback of the contributing primary buildings and accessory structures found in the immediate vicinity
 - Setbacks of like structures historically found on the site as determined by historic maps, site plans, or photographs
 - Shape of lot
 - Alley access or lack thereof
 - Proximity of adjoining structures
 - Property lines
 - Easements
 - The extent of and the number of protrusions beyond the footprint such as bays/oriels, balconies and roof overhangs
5. Parking pads and outbuildings should be located at the rear of the lot.
 6. Vehicular storage, such as garages and carports, shall not be a part of a new primary building with a residential form unless lot constraints prevent a detached outbuilding or unless the attached garage can be fully located at the basement level and accessed from the rear or side, inset a minimum of four feet from the main side wall of the house.
 7. Driveways from the street are appropriate if there is an existing curb-cut or if the lot lacks an alley. When a driveway is appropriate, it should not exceed twelve feet in width and should extend to at least the rear of the building.



V. NEW CONSTRUCTION-INFILL

8. New buildings should be connected to the street with an uncovered walkway from the porch/entrance to the street/sidewalk/curb.
9. New infill buildings should be oriented to (facing) the shortest street-facing side of a lot.
10. In the case of duplexes on a corner lot, entrances or porches that face the rear or sides should look like secondary entrances and porches, even if the entry/porch serves as the primary entrance to one of the units.
11. Utility connections such as gas meters, electric meters, phone, cable, and HVAC condenser units should be located so as to minimize their visibility from the street. Generally, utility connections should be placed no closer to the street than the mid-point of the structure. It is recommended that power lines should be placed underground, if they are carried from the street and not from the rear or an alley.
12. Where sidewalk-accessed mailboxes are rare, new mailboxes should be placed on the front wall of the building or a porch post.
13. Landscaping, sidewalks, signage, lighting, street furniture, and other work undertaken in public spaces (Metro owned and public right-of-ways) by any individual, group or agency, shall be presented to the MHZC for review of compatibility with the historic character of the district.

Utilities should generally be located on the ground and not on upper-level walls.

D. PROPORTION & RHYTHM OF OPENINGS

1. The relationship of width to height of windows and doors, and the rhythm of solids (walls) to voids (door and window openings) in a new building shall be compatible, by not contrasting greatly, with surrounding historic buildings.
2. Window openings on the primary street-related or front façade of new construction should be representative of the window patterns of similarly massed historic structures within the district. In most cases, every eight to thirteen horizontal feet of flat wall surface should have an opening (window or door) of at least four square feet. More leniency can be given to minimally visible side or rear walls. Wide openings for sliding glass doors or roll-up doors are not appropriate on the front half of a building and a street-facing side.



In many districts, windows are generally twice as tall as they are wide.



V. NEW CONSTRUCTION-INFILL

3. Double-hung windows should exhibit a height to width ratio of at least 2:1, where double-hung windows are a typical feature of the neighborhood. Generally, windows on upper floors should not be taller than windows on the main floor since historically first floors have higher ceilings than upper floors and so windows were typically taller on the first floor, if not the same height.



VI. NEW CONSTRUCTION-ADDITIONS

A. GENERAL PRINCIPLES

1. Additions to historic buildings should be compatible with the historic buildings to which they are attached.
2. Additions to non-contributing buildings should be considered in terms of new construction-infill, taking into account existing conditions and historic context. Existing conditions do not need to be altered to meet the design guidelines; however, if they are to be altered, the result must meet the design guidelines.
3. Contemporary designs for additions to existing properties are not discouraged when such additions do not destroy significant historical, architectural, or cultural material; and when such design is compatible, by not contrasting greatly, with the size, scale, material, and character of the property, neighborhood, or environment.

For additions in the following districts, also see additional guidance in [Part II of the Consolidated Design Guidelines](#):

*Edgehill
Inglewood Place
Park & Elkins
Richland-West End
Salemtnown
South Music Row
Whitland
Woodlawn West*

B. MASS, SCALE & CONNECTION

1. An addition should be situated at the rear of a building in such a way that it will not disturb either front or side facades. Additions should be physically distinguished from the historic building and generally fit within the shadowline of the existing building. A side addition may be possible if all these conditions are met:
 - a. The lot width exceeds 60 feet or the standard lot width on the block.
 - b. The addition sits back from the front face of the historic structure at or beyond the midpoint of the building.
 - c. The addition is at least two feet (2') shorter than the primary massing of the historic building and one-story in height.
 - d. The width of the side addition is approximately half the width or less of the primary massing of the historic building.
 - e. The foundation is at or below the existing building's foundation.



VI. NEW CONSTRUCTION-ADDITIONS

- f. The roof form is hipped or side-gable roof form.
 - g. The addition does not create a front parking pad by preventing a driveway from extending to the rear of the addition.
2. In order to ensure that an addition has achieved proper scale, the addition should be shorter and narrower than the existing building. One story additions should set in at least 1' from the rear corner and two-story additions should set in at least 2' from the rear corner.
 3. Generally, additions should not exceed the number of stories of the historic building to which it is attached. Exceptions to an addition not being narrower and shorter than the historic building follows in sections 4 and 5; however an addition may not be both taller and wider.
 4. Rear additions that extend to be wider than the historic building may be possible when the applicant has exhausted other options and in the following conditions:
 - The lot is unusually shallow for the historic context.
 - The lot is wider than typical lots in the immediate vicinity.
 - The historic building is narrower than 30 feet on a standard lot size.
 - The historic building is shifted greatly to one side of the lot on a typical lot size.
 - The addition is designed to leave the corners of the building visible and intact and does not wrap around a corner.
 - The project does not also include a side addition to the historic building.
 - Eaves and ridges of addition do not exceed the main corresponding elements of the historic building.
 - The portion that extends beyond the side wall does not exceed one-story.
 - The addition does not create a front parking pad by preventing a driveway from extending to the rear of the addition.
 5. Rear additions that are taller than the historic building may be possible when the applicant has exhausted other options and in the following conditions:
 - The grade rises steeply towards the rear of the lot
 - The historic building is one or one and one-half stories tall and one to two-feet of additional height will allow for usable second-story space that otherwise is unavailable. Additions that are taller than the historic building are not appropriate on buildings that are two-stories or more.



VI. NEW CONSTRUCTION-ADDITIONS

- The proposed addition does not extend more than two-feet above the main roof form of the historic building.
- The taller portion of the addition is fully inset 2' from the historic house's sidewalls.
- The portion of the proposed addition that extends taller than the historic building is all roof, as seen from the street.
- No portion of the proposal increases the height of the historic building itself, only the addition, with the exception of "ridge raises."

6. Some one and one and one-half story, side-gabled, historic buildings may increase in height with a "ridge raise." The purpose of a ridge raise is to allow for conditioned space in the attic and to discourage large rear or side additions. As such, a ridge raise is inappropriate for a proposal that adds additional stories or height beyond the ridge raise; that includes an addition that is wider than the historic house; that includes a side addition; that includes a rooftop deck or that is proposed to be on a building that is two or more stories. Ridge raises may be used in the following ways and in the following conditions:

- The historic building is one or one and one-half stories.
- The historic building has a side-gable roof form without clipped gables.
- The raised portion sits in a minimum of two feet (2') from each side wall and is raised no more than two feet (2') of total vertical height within the same plane as the front roof slope.

7. Where an addition attaches to a historic roof form, it shall sit below the ridge of the roof, except in the case of "ridge raises."
8. The height of the addition's roof, eaves, and foundation should be less than or equal to the existing structure.
9. Visually evident roof slopes should match the roof slopes of the existing structure, and roof planes should set in accordingly for rear additions.
10. In order to achieve compatibility in scale, an addition should not be larger than the existing building. The diversity of housing type and size are character-defining features of the historic districts; therefore, it is not the goal of the overlay to ensure that all buildings can become the same size. Generally, the

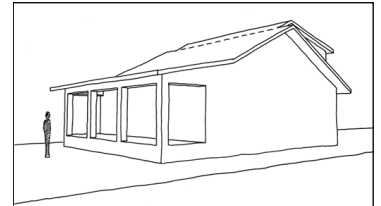

Appropriate Ridge Raise: rear dormers are set in from the side wall of the existing building at least two feet, creating a division between new and old.

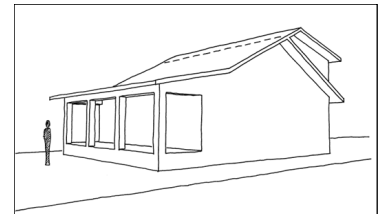

Inappropriate Ridge Raise: rear dormers have no inset; they visually and physically alter the roof structure of the existing building.



VI. NEW CONSTRUCTION-ADDITIONS

addition's footprint should not more than double the footprint of the historic building.

11. Additions which are essentially a house-behind-a-house with a long narrow connector are not appropriate, as the form does not exist historically.
12. The creation of an addition through enclosure of a front porch is not appropriate. The creation of an addition through the enclosure of a side porch may be appropriate if the enclosure is constructed in such a way that the historic form, openings, and features of the porch remain visible and prominent and the enclosure has an open design. "Enclosure" does not include screening-in porches that do not require the removal of porch posts or the addition of substantial new framing for the screening. This type of screening is not reviewed.
13. A new addition should be constructed in such a manner that if the addition were to be removed in the future, the essential form and integrity of the historic structure would be unimpaired.
14. Adding front porches to contributing houses that did not have a front porch historically is not appropriate. Additions of front porches to non-historic buildings may be possible if the resulting building has an appropriate front-setback.
15. Vehicular storage such as garages, carports, and porte-cocheres should not be added to buildings where there is no historic evidence of such. An exception may be when a garage, that is part of an addition, is fully located at the basement level and accessed from the rear or accessed from the side and inset at least four feet from the back corner of the historic house.
16. When an addition includes a garage or roll up door/window, the door(s) should be located on the rear. (See previous section for guidance on attached garages.) Garage, roll up, or sliding glass doors on the side of an addition may be appropriate if the wall that includes the door is stepped back from the primary side wall of the historic building by at least 4 feet.



VI. NEW CONSTRUCTION-ADDITIONS

C. SITING & SETBACK

1. The setback from front- and side-yard property lines established by the historic buildings should be maintained.
2. There should be a minimum of 20' between primary buildings (including additions) and outbuildings. Less than 20' may be appropriate in the case of site constraints such as shallow lots.
3. The Commission has the ability to determine appropriate building setbacks of the required underlying base zoning for new construction, additions, and accessory structures (ordinance no. 17.40.410).
 - a. Front additions are rarely appropriate. When they are, such as a porch for a non-historic building, the new front setback generally should be the average between the historic front setbacks established on either side of the building.
 - b. Side setbacks for rear additions may maintain the existing side setback, if the primary building is historic.
 - c. Rear setbacks are determined based on a combination of bulk standards and an appropriately scaled building for the district.
 - d. When a building is unable to meet bulk standard setback requirements, appropriate setbacks will be determined based on:
 - The existing setback of the contributing primary buildings and accessory structures found in the immediate vicinity
 - Setbacks of like structures historically found on the site as determined by historic maps, site plans, or photographs
 - Shape of lot
 - Alley access or lack thereof
 - Proximity of adjoining structures
 - Property lines
 - Easements
 - Protrusions beyond the footprint such as bays/oriels, balconies, and roof overhangs



VI. NEW CONSTRUCTION-ADDITIONS

4. New parking pads should be located at the rear of the lot.
5. New driveways from the street are appropriate if there is an existing curb-cut or if the lot lacks an alley. When a driveway is appropriate, it should not exceed twelve feet in width and should extend to at least the rear of the building.
6. In the case of duplexes on a corner lot, entrances or porches that face the rear or sides should look like secondary entrances and porches, even if the entry/porch serves as the primary entrance to one of the units.
7. Utility connections such as gas meters, electric meters, phone, cable and HVAC condenser units should be located so as to minimize their visibility from the street. Generally, utility connections should be placed no closer to the street than the mid-point of the structure. It is recommended that power lines should be placed underground, if they are carried from the street and not from the rear or an alley.
8. Where sidewalk-accessed mailboxes are rare, new mailboxes should be placed on the front wall or a porch post.
9. Landscaping, sidewalks, signage, lighting, street furniture, and other work undertaken in public spaces (Metro owned and public right-of-ways) by any individual, group or agency, shall be presented to the MHZC for review of compatibility with the historic character of the district.

D. PROPORTION & RHYTHM OF OPENINGS

1. The relationship of width to height of windows and doors, and the rhythm of solids (walls) to voids (door and window openings) in an addition shall be compatible, by not contrasting greatly, with the historic building, or in the case of additions to non-historic buildings, with historic buildings in the vicinity.
2. Window openings should be representative of the window patterns of the historic building or in the case of additions to non-historic buildings, with historic buildings in the vicinity. Wide openings for sliding glass doors or roll-up doors are not appropriate on side elevations, unless stepped back from the primary side wall of the historic building by at least 4 feet.



VI. NEW CONSTRUCTION-ADDITIONS

3. Double-hung windows should exhibit a height to width ratio of at least 2:1, where double-hung windows are a typical feature of the neighborhood. Generally, windows on upper floors should not be taller than windows on the main floor since historically first floors have higher ceilings than upper floors and so windows were typically taller on the first floor, if not the same height.

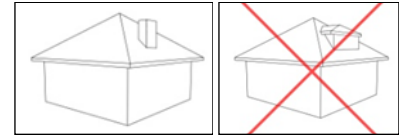

The dormer shown added on the right image is inappropriate because it required the removal of the chimney.

E. ROOF ADDITIONS: DORMERS, DECKS, SKYLIGHTS AND SOLAR PANELS

1. Rooftop additions, other than dormers, skylights and solar panels are not appropriate for buildings with pitched roofs or for buildings with flat/parapet roofs that are less than four-stories.



Dormers should not be added to secondary roof planes.

2. Dormer additions are appropriate for some historic buildings as they are a traditional way of adding ventilation and light to upper stories. The addition of a dormer that would require the removal of historic features such as an existing dormer, chimneys, cupolas, or decorative features is not appropriate.

3. Front dormers should only be added to historic buildings when there is physical or pictorial evidence to show the building had a dormer, unless the specific district allows otherwise.

4. Rear dormers should be inset from the side walls of the building by a minimum of two feet (2').

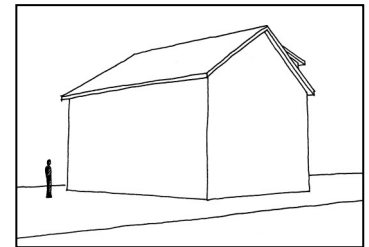

Appropriate rear dormers are set in from the side wall of the existing building at least two feet (2'), creating a division between new and old.

5. Side dormers should be compatible with the scale and design of the building. Generally, this can be accomplished with the following:

a. New dormers should be similar in design and scale to an existing dormer on the building. If there are no existing dormers, new dormers should be similar in design and scale to an existing historic dormer or another historic building is similar in style and massing.

b. The number of dormers and their location and size should be appropriate to the style and design of the building. Often the width of roof dormers relate to the openings below. The symmetry or lack of symmetry within a building's

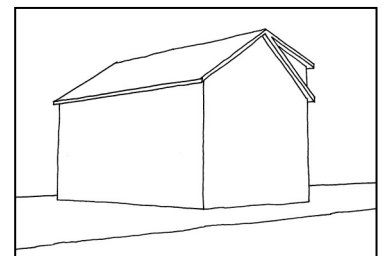

Inappropriate rear dormers have no inset; they visually and physically alter the roof structure of the existing building.



VI. NEW CONSTRUCTION-ADDITIONS

- design, should be used as a guide when placing dormers.
- c. Dormers should not be added to secondary roof planes.
 - d. Eave depth on a dormer should match a historic dormer on the building or the eave depth of the main roof.
 - e. The roof form of the dormer should match the main roof form of the building or be appropriate for the style.
 - f. The roof pitch of the dormer should generally match the pitch of historic dormers or the roof pitch of main roof form.
 - g. The ridge of a side dormer should be at least two feet (2') below the ridge of the existing building; the sidewalls of the dormer should be inset at least two feet (2') from the wall below or adjacent valley; and the front wall of the dormer should setback a minimum of two feet (2') from the wall below. (These minimum insets will likely be greater than two feet (2') when following the guidelines for appropriate scale.)
 - h. Dormers should generally be fully glazed and aprons below the window should be minimal.
 - i. The exterior material cladding of side dormers should match the primary or secondary material of the main building.
6. Rooftop decks shall not be added to existing roof forms as they can dramatically change a historic roof form and are not typical of historic building forms. Rooftop decks are not appropriate on side additions or the side of rear additions but may be appropriate on the back or a rear addition if the deck is surrounded on all sides by an appropriately pitched roof, and if the addition does include a ridge raise and is no taller than the historic house.
 7. Solar panels should be parallel with the existing roof slope and not extend beyond the roof edge. Where possible, solar panels should be located on rear or side roof planes or outbuildings rather than front roof planes of primary buildings.
 8. Skylights should be parallel with the existing roof slope and have a flat profile. In general, skylights should not be located on the front roof plane and should not exceed 15 square feet on any given roof plane.



VII. NEW CONSTRUCTION-DETACHED OUTBUILDINGS & GARDEN STRUCTURES

A. GENERAL PRINCIPLES

1. New free-standing buildings and structures that are less than 100 square feet, do not have a permanent foundation, and are located to the rear of the property, do not require a preservation permit.
2. Garden or play structures that do not have a permanent foundation, do not have sides, and are less than 200 square feet do not require a preservation permit.
3. Parameters provided by these design guidelines is per lot and should not be considered as a maximum per unit, in cases where zoning allows for more than one unit.
4. The Commission recognizes that new outbuildings cannot meet the scale and massing of historic outbuildings and still allow for modern uses so has created base dimensional requirements to ensure that new outbuildings and revisions to existing outbuildings still take into consideration the historic context.
5. How an outbuilding can be used is reviewed by the Metro Department of Codes & Building Safety.

*For outbuildings in the following districts, also see additional guidance in [Part II of the Consolidated Design Guidelines](#):
Edgehill
Richland-West End*

B. Massing & Form

1. The footprint of an outbuilding should not exceed 750 square feet, except in the case of lots that exceed 10,000 square feet. In those cases, the footprint shall not exceed 1000 square feet.
2. Ridge heights shall not exceed 25' from existing grade for interior lots and shall not exceed the height of the primary dwelling for corner lots. The height of the historic building shall be determined based on the historic building and not ridge raises or tall additions. *The primary building shall be measured from top of foundation or first level floor line when the foundation is not visible or it is taller or shorter than the general location of the floorline.* While an outbuilding may have a ridge height taller than the primary building for interior lots, a full two-story outbuilding is only appropriate behind a two-story primary building.



VII. NEW CONSTRUCTION-DETACHED OUTBUILDINGS & GARDEN STRUCTURES

3. Maximum foundation height shall not exceed one foot from existing grade on the corner of the building that sits on the highest area of existing grade. (Grade may need to be adjusted for water runoff but should not be built up for the sole purpose of increasing building height.)
4. On outbuildings behind primary buildings that are one or one and one-half stories, wall heights of an outbuilding shall not exceed twelve feet and for an outbuilding behind a primary building that is two or more stories, wall heights of an outbuilding shall not exceed 17' from existing grade as measured from top of finished floor/slab. Measurements shall be taken from top of finished floor/slab to ridge or to where the sidewall and the roof intersect, regardless of whether the soffits are of an open or closed design.
5. Roof slope of the outbuilding shall be at least 4/12.
6. Stairs to another level, not counting stairs to access a porch or stoop, should be interior.
7. Eaves should not extend more than two feet.

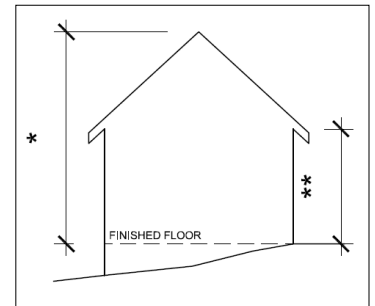

Example of how measurements are taken.

C. SITING & SETBACKS

1. Generally new outbuildings should be placed in rear yards, close to the rear property line or in the original location of an historic accessory structure.
2. In many cases, outbuildings may be as close as 5' to a rear or side property line, with the following exceptions:
 - a. On corners lots the outbuilding should be a minimum of 10' from the street-side property line or 20' if the garage doors face the side street.
 - b. On double-frontage lots, the rear setback should match the historic context on the secondary street. If there is no context, it should be a minimum of 10' from the rear property line or 20' if the garage doors face the rear.
 - c. On lots where a rear property line abuts a side-property line and there is no rear alley to separate the two properties, the rear setback should be a minimum of 10'.



VII. NEW CONSTRUCTION-DETACHED OUTBUILDINGS & GARDEN STRUCTURES

3. An outbuilding should be a minimum of 6' from any other building, even those that may be on neighboring properties.
4. When a setback determination is found to be appropriate, the “edge of the building” shall be considered the maximum of any protrusion beyond the footprint such as bays/oriels, balconies, awnings and hoods, and roof overhangs.
5. There should be a minimum of 20' between primary buildings (including additions) and outbuildings. Less than 20' may be appropriate in the case of site constraints such as shallow lots. (Repeat of guidance VI(C)(2).)
6. Driveways from the street are appropriate if there is an existing curb-cut or if the lot lacks an alley. When a driveway is appropriate, it should not exceed twelve feet in width and should extend to at least the rear of the building. (Repeat of guidance V(7).)

D: ADD-ON FEATURES

1. Add-on features are available for outbuildings that will not be calculated into maximum square footage but do need to meet setback requirements. Larger versions of the added features or features different than what is proposed in this section will be considered within the previous design requirements.

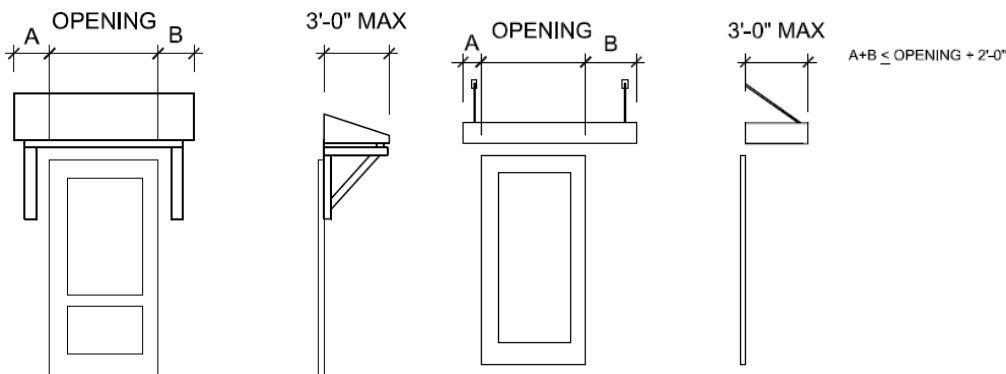

2. Hoods & Awnings
 - a. Hoods and awnings should not exceed 3' in depth.
 - b. Hoods and awnings should only be located over windows and doors.
 - c. Width shall not exceed the opening it covers by more than 2' on each side to allow for brackets and connections.



VII. NEW CONSTRUCTION-DETACHED OUTBUILDINGS & GARDEN STRUCTURES

3. Stairwell Bay

- a. All stairs should be enclosed. For forms that have a footprint of less than 500 square feet and that are 1.5 of 2 stories, a stairwell bay may be added.
- b. No more than one per building.
- c. A stairwell bay should not exceed 8' wide and 4' deep

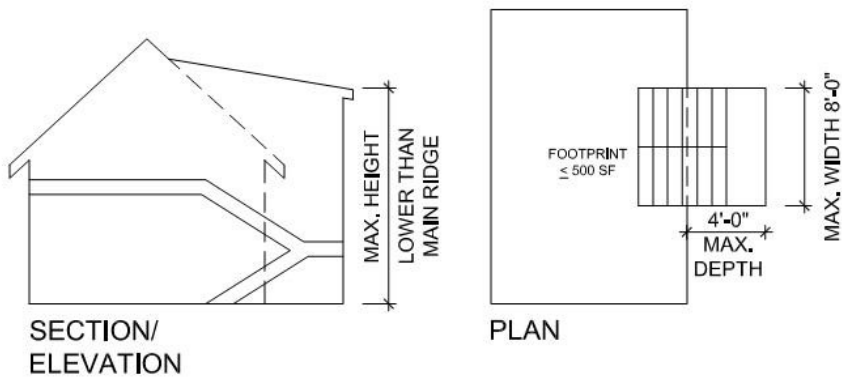

4. Enclosed Vestibule

- a. Vestibules are fully or partially enclosed stoops.
- b. They should not exceed 5' wide and 4' deep.
- c. Should not exceed one-story.
- d. No more than one per building.

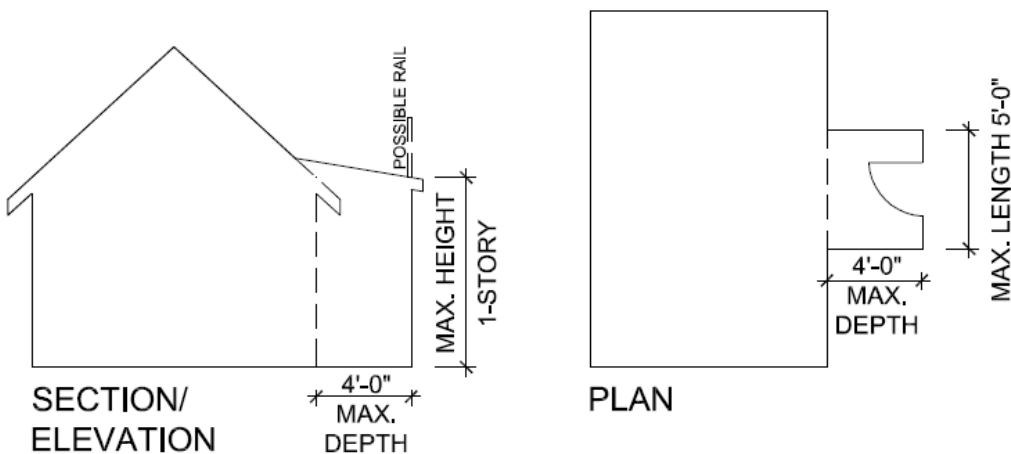



VII. NEW CONSTRUCTION-DETACHED OUTBUILDINGS & GARDEN STRUCTURES

- 5. Projecting Balcony
 - a. Should not have a cover.
 - b. Should not exceed 30 square feet
 - c. No more than one per building.

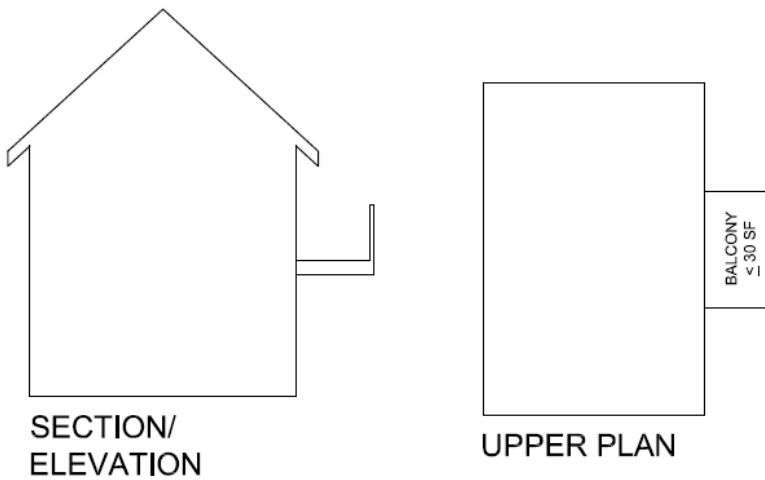

- 6. Projecting Oriel
 - a. Should not exceed a depth of 2'
 - b. No taller than 10'
 - c. No wider than 10'
 - d. No more than one per building.

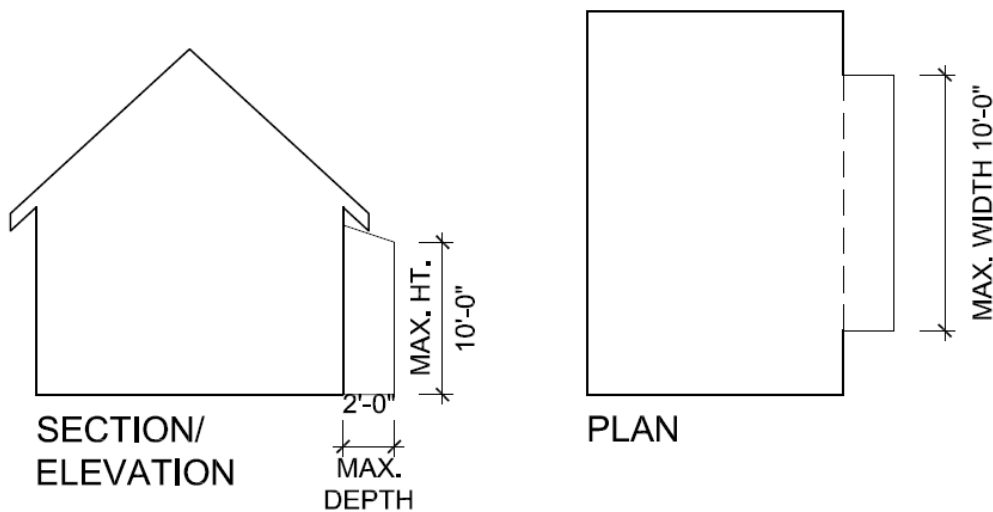



VII. NEW CONSTRUCTION-DETACHED OUTBUILDINGS & GARDEN STRUCTURES

7. Projecting Porch on the ground floor

- a. Should not exceed full width of the side of the building to which it is attached.
- b. Should not exceed 6' in depth
- c. Should be one-story only
- d. No more than one per building.

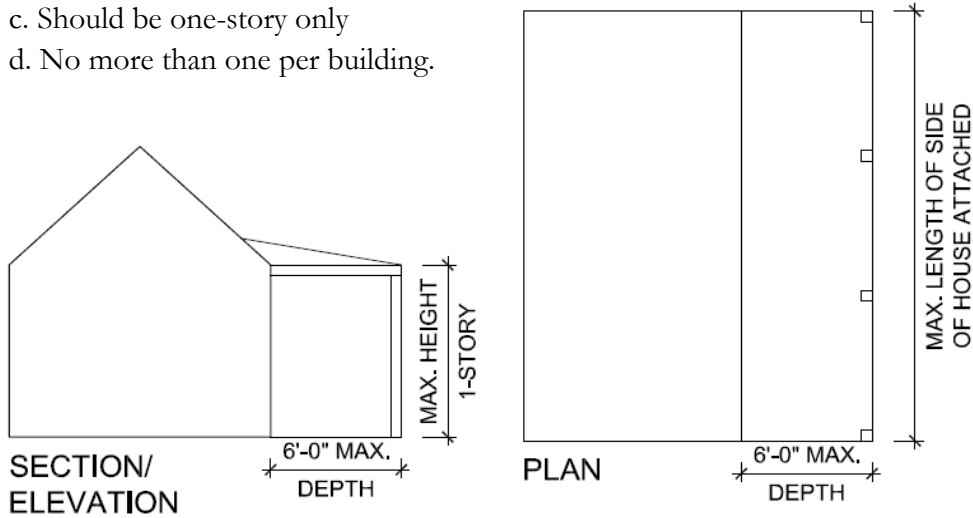

8. Roof Dormer

- a. 14' wide total maximum
- b. Front-face of each dormer should be primarily glazing
- c. No more than one per roof plane
- d. Inset a minimum of 2' from side walls and from wall below
- e. Not appropriate for 2-story outbuildings

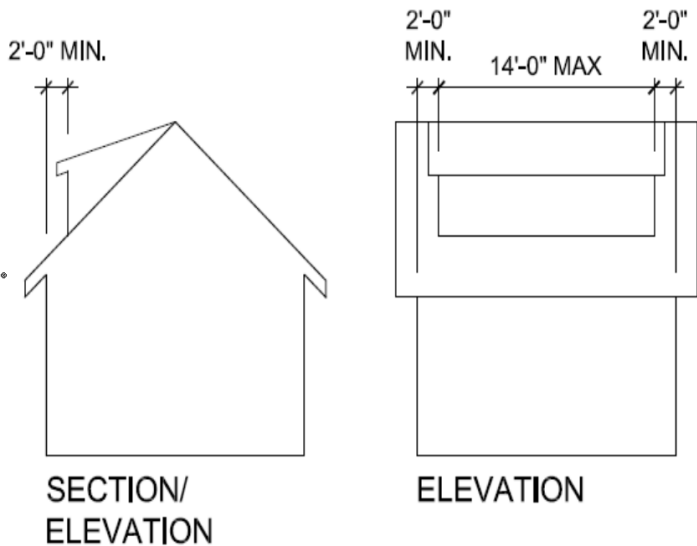



VII. NEW CONSTRUCTION-DETACHED OUTBUILDINGS & GARDEN STRUCTURES

9. Wall Dormer

- a. 14' wide total maximum.
- b. Front-face of each dormer should be primarily glazing.
- c. No more than one per building.
- d. Inset a minimum of 2' from side walls.
- e. Not appropriate for 2-story outbuildings

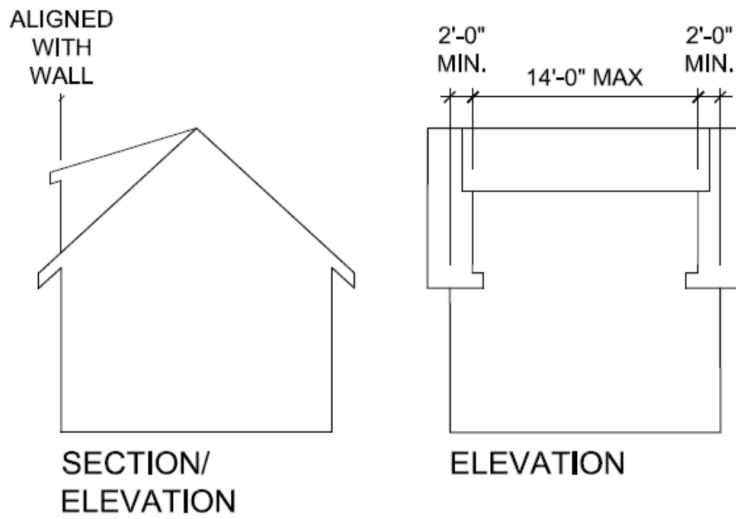



VIII. RELOCATION

A. PRINCIPLES

1. Moving a historic building from its original site should be avoided.
2. Moving a non-contributing building, or a building which has irretrievably lost its architectural and historical integrity, outside of the district is appropriate. Moving it elsewhere within the district is not appropriate.



B. GUIDELINES

1. Moving a building into the district is appropriate if the building will be compatible with the historic buildings surrounding the new location in terms of height, scale, setback, and rhythm of spacing, materials, texture, details, material color, roof shape, orientation, and proportion and rhythm of openings.
2. Moving a building out of the district is not appropriate unless:
 - a. the building does not contribute to the district's historical and architectural significance, or has irretrievably lost its architectural and historical integrity;
or
 - b. the building is historic, but the loss of its architectural and historical integrity in its original location is certain.
3. Moving a building from one location to another within the district is not appropriate unless:
 - a. the building will be compatible with the historic buildings surrounding the new location in terms of height, scale, setback and rhythm of spacing, materials, texture, details, material color, roof shape, orientation, and proportion and rhythm of openings; and
 - b. if historic, the loss of its architectural and historical integrity in its original location is certain.

In some cases, moving a residential building to a new foundation also requires approval of the Metro Planning Commission, according to 13-3-502 of the Tennessee Code Annotated. Please contact the Planning Department for additional information.



IX. DEFINITIONS

Addition: *New construction that increases the square footage or height of an existing structure. Common forms of additions that are reviewed are dormers, covered porches, carports, porte cocheres and the addition of conditioned spaced.*

Adjacent: *Close proximity, surrounding*

Appropriate: *Suitable for, or compatible with, a property or district, based on accepted standards and techniques for historic preservation.*

Appurtenances: *Fences, walls, paving, streetlights, curbs, gravel, signs, satellite dishes, fountains, mailboxes, and other accessory or adjunct permanent built features related to a building or streetscape and those features or structures installed for more than 30 days in a calendar year.*

Block Face: *One side of a street block.*

Boxed entrance: *A vestibule that is primarily enclosed. Common feature of English cottage and Tudor style buildings. Also known as an “enclosed entrance” or “enclosed portico or vestibule.”*

Certificate of Appropriateness: *See Preservation Permit.*

Character-defining Features: *Character-defining features include the overall shape of the building, its materials, craftsmanship, decorative details, features, as well as the various aspects of its site and environment.*

Clerestory Window: *A portion of an interior rising above the roof and having windows admitting daylight to the interior.*

Contributory Status: *Contributing buildings are those that contribute to the historic character of the district, and non-contributing buildings do not contribute to the overlay’s historic character. Contributory status is determined based on the historic integrity of the building, the history and development of the district, and the date of construction. Generally, contributory status for each building is evaluated at the time the overlay is adopted; however, contributory status can change over time as new information becomes available and as districts age.*

Deck: *A floor that is flush with the ground, or slightly above, exposed to the elements and does not have a roof over it.*



Example of a boxed entrance.



VIII. DEFINITIONS

Demolition: *The tearing down of a building, or a portion thereof.*

Dormer: *A vertical window projecting from, or recessed into the slope of a roof; usually provided with its own roof. There are three basic types:*

Roof dormer: All walls (side and front) project out from the roof but not from the wall below

Wall dormer: Front of dormer is flush with the wall below

Recessed (or inset) dormer: Has both side walls set into the roof rather than projecting from the roof.

Double frontage lot: *A lot, other than a corner lot, that has frontage on two or more streets that do not intersect at a point abutting the property.*

Elevation: *A scaled drawing that illustrates the view of a face of a building. Also used as a synonym for façade.*

Embossed Grain: *The embossed pattern pressed into a manufactured material, simulating wood grain or texture.*

Facade: *An exterior face of a building.*

Form: *The formal structure of a building—the manner of arranging and coordinating the elements and part of a building. A sense of three-dimensional mass and volume, the external outline of the building.*

Footprint: *The area on a project site that is used by the building structure and is defined by the perimeter of the building plan. Parking lots, landscapes, and other nonbuilding facilities are not included in the building footprint.*

Half Story: *Usable space fully under the roof, often identified by dormers, skylights or windows in a gable field. The primary wall and eave heights are consistent with single-story building.*

Historic: *A structure or site, usually constructed more than fifty years ago, which possesses historical or architectural significance, based on the criteria for listing in the National Register of Historic Places.*

Muntin: *A secondary framing member to hold panes within a window or glazed door.*



VIII. DEFINITIONS

Mullion: *A vertical member separating (and often supporting) window, doors or panels set in series.*

New Construction: *Any building, addition, structure, or appurtenance constructed on a lot after the establishment of a historic overlay.*

Orientation: *The directional expression of the front facade of a building, i.e., facing the street, facing north.*

Outbuilding: *An additional structure on a lot where the primary building has a residential form. Form, rather than current or potential use or zoning, is the factor which determines what is a primary building and what is an outbuilding. Some examples of outbuildings are carports, garages, sheds, studios, accessory dwellings, pool houses, play houses, and garden structures, such as pergolas and green houses. The Metro Department of Codes & Building Safety determines how an outbuilding can be used.*

Period of Significance: *The span of time during which significant events and activities occurred. Events and associations with historic properties are finite; most properties have a clearly definable period of significance.*

Porch Beam: *(Sometimes also referred to as a “porch rack.”) The beam at the top of porch columns which supports the porch roof.*

Port Cochere: *A carriage porch or portico-like structure generally located at a secondary entrance to a building and attached to the primary building.*

Oriel: *A projecting bay or window forming the extension of a room. Unlike a “bay,” an oriel typically does not have a foundation.*

Preservation Permit: *A legal document issued by the Metropolitan Historic Zoning Commission confirming review and approval of work to be done on property within the boundaries of an historic or neighborhood conservation zoning overlay districts. A preservation permit is required before obtaining a building permit. Previously called Certificate of Appropriateness.*

Public Right-of-Way: *Publicly owned and maintained streets and walkways. For the purposes of historic, neighborhood conservation, and landmark zoning overlays, alleys are not considered public rights-of-way.*



VIII. DEFINITIONS

Public Space: *Any area owned, leased, or for which there is held an easement by a governmental entity, or an area that is required to be open to the public.*

Reconstruction: *Construction of an accurate replica of a historic building or portion thereof, based on physical, pictorial or documentary evidence.*

Relocation: *The moving of a building from one site to another.*

Roof Overhang: *The portion of the roof that extends beyond the wall of the building.*

Rooftop Deck: *An uncovered deck projecting from or recessed into the roof form of a building. It is generally located at or above the primary eave of the portion of the roof to which it is attached.*

Setback Determination: *The Commission has the ability to determine appropriate building setbacks of the required underlying base zoning for new construction, additions, and accessory structures (ordinance no. 17.40.410). The commission has a policy to follow the setbacks of bulk zoning and setbacks specifically noted in these design guidelines. Any construction approved to take place within the setback area is a setback determination.*

Shall: *What must happen.*

Shadowline: *The two-dimensional outline of a building's mass as viewed on a front elevation. This typically includes the primary walls and roof, but excludes chimneys and bays*

Should: *What must happen unless circumstances illustrate why an alternative is more appropriate.*

Style: *Architectural Style is characterized by the features that make a building or other structure notable or historically identifiable. Styles emerge from the history of a society and often reflect changing fashions, beliefs, and religions, or the emergence of new ideas, technology, or materials.*

Vestibule: *A small foyer leading into a larger space. Entrance vestibules are generally enclosed on the sides.*

Yard Art: *Man-made ornament in a private yard or garden that is not attached to a structure and is not a structure itself.*



Sunnyside in Sevier Park
3000 Granny White Pike
Nashville, TN 37204

Phone: 615-862-7970
historicalcommission@nashville.gov

The Metropolitan Historic Zoning Commission reviews applications to create new historic overlay districts and reviews and approves preservation permits in historic and conservation districts for new construction, alterations, additions, repair, and demolition. For design guidelines, permit applications, and meeting information, visit us at www.nashville.gov/mhc.

WE ARE ON THE WEB AT WWW.NASHVILLE.GOV

These design guidelines were funded by the Tennessee Historical Commission and the Metro Historical Commission Foundation, in partnership with Council Members, stakeholders, and the Center for Historic Preservation at Middle Tennessee State University.

Councilmembers: Scott Davis and Sean Parker (5), Brett Withers (6), Anthony Davis and Emily Benedict (7), Colby Sledge (17), Burkley Allen and Tom Cash (18), Freddie O’Connell (19), Mina Johnson and Thom Druffel (23), Kathleen Murphy (24)

Stakeholders: David Skeen (Belle Meade Links Triangle), Lindsey Moffat (Belmont-Hillsboro), Ben Gortmaker (Bowling House District), Grace Renshaw (Cherokee Park), Rich McCoy (East End), Sheridyn Williams (Eastdale), Bob Rehly (Eastwood), Rob Benschopf (Edgehill), Ira and Nancy Chilton (Elmington), John TeSelle (Hillsboro-West End), Rebecca Freeman (Inglewood Place), Phil Thomason (Kenner Manor), Elizabeth Smith (Lockeland Springs), Will Churchill (Maxwell), Pat Williams (Park & Elkins), Steve Sirls (Richland-West End), Brad Snider (Salemtnown), Jane-Coleman Cottone (State Historic Preservation Office rep), Chris Aycock (Waverly-Belmont), Helen Curnutte (Whitland), Irwin Venick (Woodlawn-West), Martin Wieck (designer/architect rep), Craig Kennedy (designer/architect rep), Kaitlyn Jones (MHZC Representative)

Metro Historical Commission Members: Menie Bell (Chairman), Cyril Stewart (Vice-chair), LaDonna Boyd, Mina Johnson, Kaitlyn Jones, Leigh Fitts, Elizabeth Mayhall, Ben Mosley, David Price, Brian Tibbs

Metro Historic Zoning Commission Staff: Tim Walker (Director), Robin Zeigler (Historic Zoning Administrator), Sean Alexander, Melissa Baldock, Victoria Hensley (intern), Paul Hoffman, Melissa Sajid, Jenny Warren



The Metro Historical Commission does not discriminate on the basis of race, color, national origin, gender, gender identity, sexual orientation, age, religion, creed or disability in admission to, access to, or operations of its programs, services, or activities. Discrimination against any person in recruitment, examination, appointment, training, promotion, retention, discipline or any other employment practices because of non-merit factors shall be prohibited. For ADA inquiries, contact Metro Historical Commission ADA Compliance Coordinator, 3000 Granny White Pike, Nashville, TN 37204, (615) 862-7970, historicalcommission@nashville.gov. For Title VI inquiries, contact Human Relations at (615) 880-3370. For all employment-related inquiries, contact Human Resources at (615) 862-6640.